

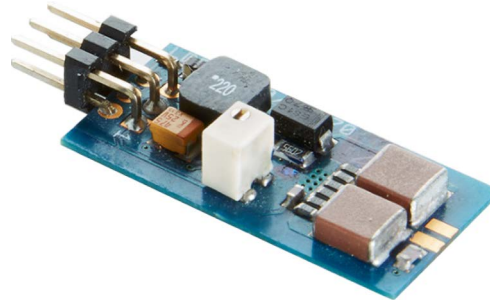

User Manual

LDP-V 10-70

LDP-V 40-70







Rev. 1905

Table of Contents

LDP-V 10-70.....	3
LDP-V 40-70.....	4
How to get started	5
How to connect the LDP-V 10/40-70	6
Operating Range Diagram.....	7
Maximum Duty Cycle vs. Output Current	8
Internal Structure of the LDP-V	9
How to use the internal HV-DC Supply	10
Pulse Output.....	10
Trigger Input.....	11
Absolute Maximum Ratings.....	11

Please pay Attention to all Safety Warnings!

Symbols used in this manual:

	Risk of electrical hazard
	Please pay special attention
	Do not
	Valuable information, remark



Rev. 1905

LDP-V 10-70

Mini Driver for Short Pulse Laser Diodes

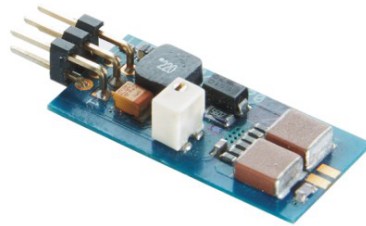

- Ultra compact OEM module: 32 x 15 mm
- 2.5 to 13 A output current
- < 4 ns rise time
- Pulse width control via trigger input (10 ns to 1 μ s)
- Rep. rates from single shot to 100 kHz
- Single +15 V supply
- Current monitor
- Applications: LIDAR, Measurements, Ignition, Rangefinding, Biochemistry, ...

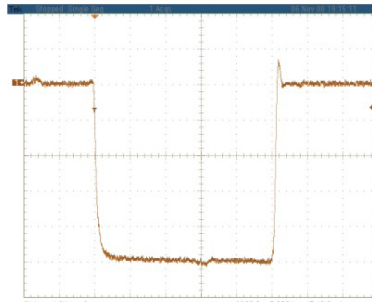

Figure: Current monitor output, scale: -2 A/Div

Technical Data*

Output current	2.5 .. 13 A
Max. output voltage	70 V
- int. high voltage	15 .. 70 V, 0.1 A, 3 W
Rise time	Typ. 3 ns, max. 4 ns
Trigger delay	Typ. 36 ns, max. 40 ns
Min. pulse width	10 ns
Max. pulse width	1 μ s
Trigger range	Single shot to 100 kHz** (refer to diagram with operating limits)
Max. duty factor	0.1 %
Trigger input	5 V into 50 Ω
Current monitor	2 A / V into 50 Ω
Supply voltage	+15 V 0.2 A
Max. power dissipation	2 W
Dimensions in mm	32 x 15 x 8
Weight	4 g
Operating temperature	-20 to +55 $^{\circ}$ C

* Measured into a short instead of laser diode. Technical data is subject to change without further notice.

** See manual for detailed information.

Product Description

The LDP-V 10-70 is the smallest available driver for nanosecond pulses. The device is optimized for size and functionality, integrating a HV-DC source and the pulsing stage into only 4.8 cm². Its typical application is driving pulsed laser diodes. Those can be mounted directly onto the LDP-V, eliminating the need for strip lines. The diode must be electrically isolated from earth (chassis) ground.

Despite its small size, the LDP-V is designed for ease of use. It eliminates the need for multiple peripheral supply units. A single 15 V DC supply and a trigger signal are all that is required for operation.



PicoLAS

FOCUSING POWER TO THE POINT

Rev. 1905

LDP-V 40-70

Ultra compact Driver Module for pulsed Lasers

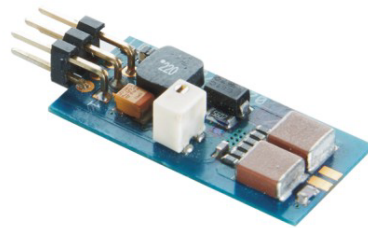

- Ultra compact OEM module: 32 x 15 mm
- 8 .. 40 A output current
- < 7 ns rise time
- Pulse width control via trigger input (15 ns to 1 µs)
- Rep. rates from single shot to 100 kHz
- Single +15 V supply
- Current monitor
- Applications: LIDAR, Measurements, Ignition, Ranging, Biochemistry, ...

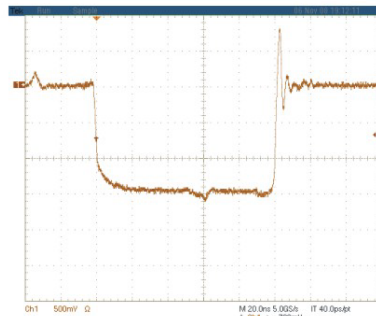

Figure: Current monitor output, scale: -10 A/Div

Technical Data*

Output current	8 .. 40 A
Max. output voltage	70 V
- int. high voltage	15 .. 70 V, 0.1 A, 3 W
Rise time	Typ. 6 ns, max. 7 ns
Trigger delay	Typ. 36 ns, max. 40 ns
Min. pulse duration	15 ns
Max. pulse duration	1 µs
Trigger range	Single shot to 100 kHz** (refer to diagram with operating limits)
Max. duty factor	0.1 %
Trigger input	5 V into 50 Ω
Current monitor	20 A / V into 50 Ω
Supply voltage	+15 V 0.2 A
Max. power dissipation	2 W
Dimensions in mm	32 x 15 x 8
Weight	4 g
Operating temperature	-20 to +55 °C

* Measured into a short instead of laser diode. Technical data is subject to change without further notice.

** See manual for detailed information.

Product Description

The LDP-V 40-70 is the smallest available source for nanosecond pulses. The device is optimized for size and functionality, integrating a HV-DC source and the pulsing stage into only 4.8 cm². Its typical application is driving pulsed laser diodes. Those can be mounted directly onto the LDP-V, eliminating the need for strip lines. The diode must be electrically isolated from earth (chassis) ground.

Despite its small size, the LDP-V is designed for ease of use. It eliminates the need for multiple peripheral supply units. A single 15 V DC supply and a triggering signal are all which is required for operation.

How to get started

Step	What to do	Check
1	Unpack your device.	
2	Make a short at the output.	
3	Turn the high voltage to the lowest value (turn poti fully counterclockwise).	
4	Connect a pulse source with the desired pulse width to the triggering input.	E.g. 100 ns, 100 Hz replate.
5	Connect your scope to the current monitor output.	Select 50 Ohm termination, trig on neg. falling edge, 200 mV/div.
6	Apply the supply voltage. Security advice: Do not touch any leads of the output or the output capacitors as they are connected to a high voltage of up to 70 V.	Connect a 15 V DC power supply to the pin header. See page 5 for details. Note: Some supplies have a voltage overshoot during turn on/turn off. This may damage the device.
7	Adjust the value of the desired pulse current (turn the poti clockwise until the current reaches the desired level).	
8	Disconnect the supply, remove the short at the output and assemble the laser diode.	Pay attention to correct polarity (anode: top, cathode: bottom).
9	Reconnect the supply and check the optical output of your laser diode.	Note: The actual current is always some percent lower than the value of step 7. Adjust the current by means of the poti.

How to connect the LDP-V 10/40-70

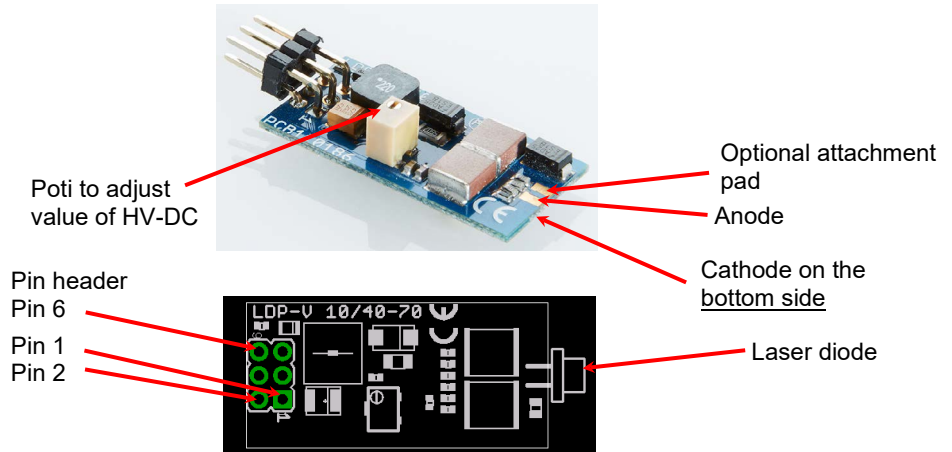

Connections via Pin header:

Pin	Name	Description
1	I_mon	Current monitor output into 50 Ohm. Scale: 2 A/V (LDP-V 10-70) / 20 A/V (LDP-V 40-70)
2	GND	Ground return
3	Trigger_In	Trigger Input into 50 Ohm
4	GND	Ground return
5	+15V	Supply voltage, connect to a power supply
6	U_HV_Ctrl	External HV setpoint input allows control over the internal HV-DC source

Trigger Input:

The trigger input requires a signal level of 5 V and is terminated with 50 Ohm.



Trigger Level Low -> High: Min. 2.4 V

Trigger Level High -> Low: Max. 0.8 V

Current Monitor Output:

The current monitor output has a scale of 2 A/V (LDP-V 10-70) respectively 20 A/V (LDP-V 40-70) with a negative signal output. It has a source impedance of 50 Ohm and must be terminated with 50 Ohm to achieve the correct scale.

Laser Diode Connection:

The laser diode connection is designed for 3-pin housing (e.g. TO-52). The pad for the cathode connection is located on the bottom side of the driver. The anode pad is on top. The third pad is not connected.



Security Advice: Do not touch any leads of the output or the output capacitors as they are connected to a high voltage of up to 70 V.



Setting the HV: The poti is a 10-turn unit without a mechanical endpoint. The poti is not for daily use. For frequent changes of the high voltage pin 6 must be used.

Operating Range Diagram

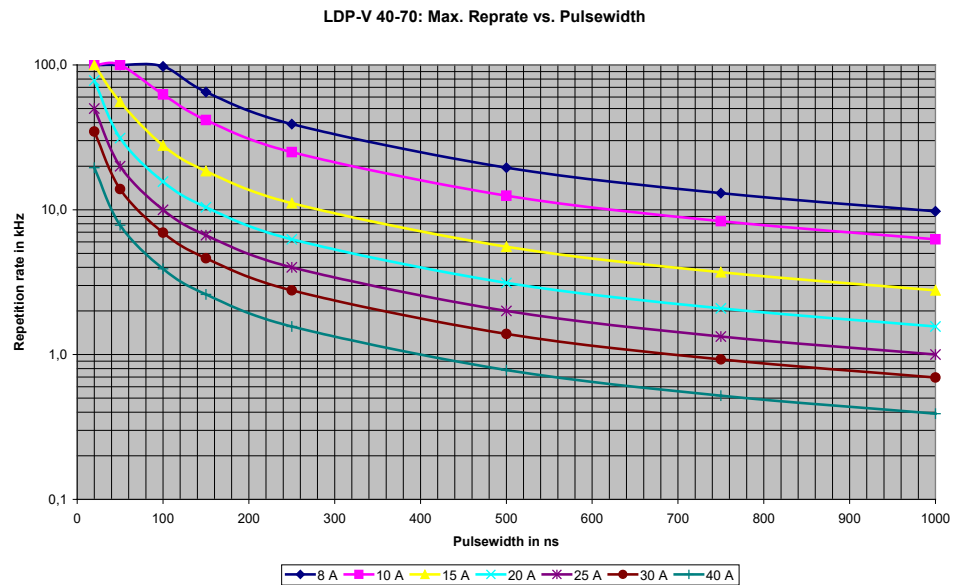
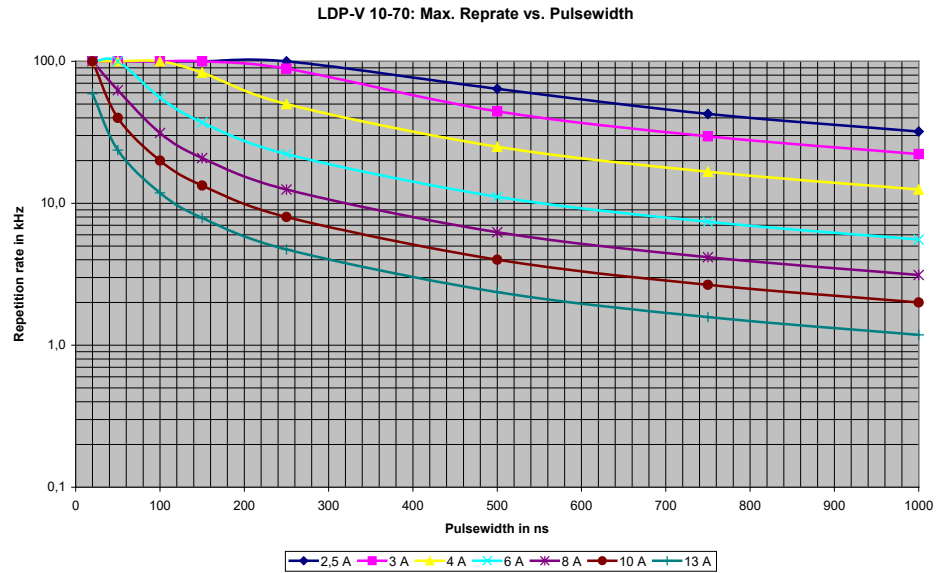

Maximum Duty Cycle vs. Output Current

The following tables show the maximum allowable duty cycle depending on a given output current.

LDP-V 10-70:

Output current in A	Max duty cycle with int. HV	Typical high voltage in V
2,5	0,0320	18,5
3,0	0,0222	21,5
4,0	0,0125	27,5
6,0	0,0056	39,6
8,0	0,0031	51,6
10,0	0,0020	63,6

LDP-V 40-70:

Output current in A	Max duty cycle with int. HV	Typical high voltage in V
8	0,0098	17,2
10	0,0063	20,6
15	0,0028	29,2
20	0,0016	37,7
25	0,0010	46,3
30	0,0007	54,8
40	0,0004	71,9

Internal Structure of the LDP-V

The LDP-V series generates the pulses by a simple but efficient principle. First, the storage capacitors (C_S) are charged through the internal HV-DC supply. When a pulse is applied at the trigger input the high speed mosfet opens and the current flows from the capacitor through the laser diode, mosfet and current sense resistors. At the end of the pulse the mosfet closes again and the current stops.

The generated current depends on the applied high voltage, the laser diode compliance voltage and its differential resistance.

The following formulas give a good estimation of the laser diode current depending on the pulser's high voltage supply U_{HV} , the laser diode compliance voltage U_{comp} and its differential resistance R_{diff} :

$$\text{LDP-V 10-70: } I_{LD} \approx \frac{U_{HV} - U_{comp}}{6 + R_{diff}}$$

$$\text{LDP-V 40-70: } I_{LD} \approx \frac{U_{HV} - U_{comp}}{1.7 + R_{diff}}$$

The laser diode current is measured with current sensing resistors (I_{Mon}). The trigger input provides full control of the driver's pulsing capability to the user. The required DC high voltage is generated with the integrated HV-DC supply. The internal supply is controlled by the HV setpoint poti or via the U_{HV_Ctrl} (Pin 6) pin.

The Diode D_{RP} prevents the laser diode from reverse currents. An over temperature protection is NOT integrated on the driver.

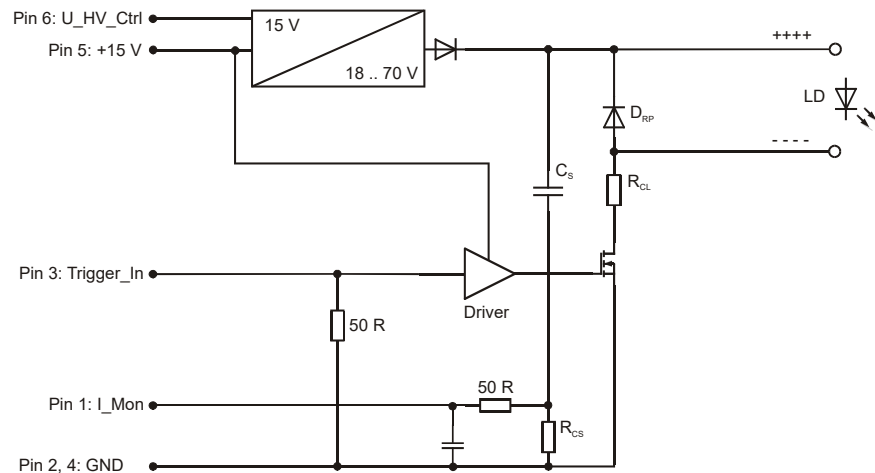

Internal Structure of the LDP-V 10/40-70

How to use the internal HV-DC Supply

The LDP-V series provides an internal high voltage supply (up to 2.5 W / 0.1 A / 70 V).

To adjust the laser diode current to the desired value follow the steps below:

1. Turn the poti fully counterclockwise
2. Apply the 15 V supply voltage
3. Start pulses
4. Measure the diode current
5. Adjust the level of the high voltage supply (hence the level of the current) by turning the poti clockwise

The HV-DC supply can also be controlled through an external setpoint signal on pin 6 of the pin header (U_HV_Ctrl): A signal level of 0 V equals the high voltage which is currently adjusted by the internal poti, a signal level of 10 V equals the minimum high voltage.

Security Advice:

Do not touch any leads of the output or the output capacitors as they are connected to a high voltage of up to 75 V.

Pulse Output

The LDP-V series provides ultra rapid pulse rise- and falltimes in the region of several nanoseconds.

However, pulse rise and fall depend on the parasitic stray inductance of the cabling to the laser diode. Direct connection without any kind of wires to the module is absolutely necessary for best results. For detailed information about the effect of the laser diode connection on the pulse shape please refer to PicoLAS Application Notes "Impedance of Diodes" and "LD-Connections".

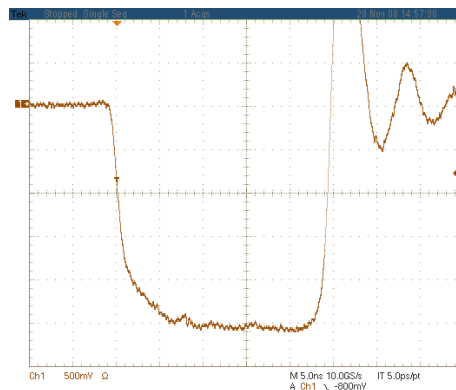

Typical Pulse Rise- and Falltimes (scale: 10 A/Div)

Trigger Input

The trigger input on the pin header is terminated with 50 Ohm to ground. The trigger source has to be able to provide a signal level of 5 V with a 50 Ohm load.

The delay between the triggering signal and the load-current is very low around 36 ns and very constant. The pulse-to-pulse jitter is very stable below 1 ns if the supply voltage and temperature are kept constant.

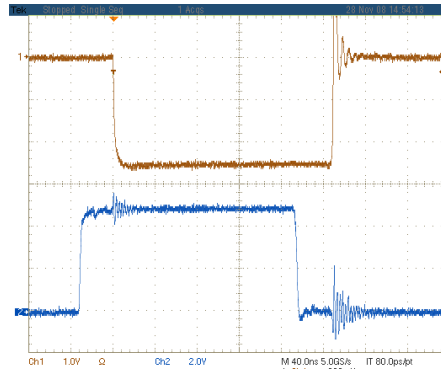

Typical trigger delay of LDP-V 10/40-70

Absolute Maximum Ratings

Supply voltage range: 12 .. 18 V

Max. voltage at HV pin: 75 V

Input voltage range U_HV_Ctrl: 0 .. 10 V

Input voltage range trigger input: 0 .. 10 V

Security Advice: Do not touch any leads of the output or the output capacitors as they are connected to a high voltage of up to 75 V.