

Data Sheet *HISbasic*

**HIS550R-0**

TO-39/TO-5 Thermal Infrared Emitter

## HIS550R-0

Thermal infrared emitter with gold plated reflector

Our HIS550R-0 is a NiCr filament based thermal emitter in a TO39 package, with a gold plated reflector that directs the radiation emitted from the rear of the filament to the front. This almost doubles our optical output power. The open emitter offers high performance for a wide spectral measuring range.

**HISbasic series** emitters have an integrated gold plated reflector that directs the radiation emitted from the rear to the front in order to achieve maximum efficiency. All our emitters offer minimum drift at constant resistance (Ohm). Infrasolids IR emitters are characterized by a very low temperature coefficient of electrical resistance. Therefore the hot resistance and the cold resistance are almost identical which eases the electrical control of the IR sources.

### Key features

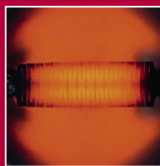

**High radiant power**

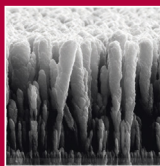

**High efficiency**



**Low cost**

- ✓ Pulsable thermal black-body infrared source mounted in an industry standard TO-39/TO-5 package.
- ✓ Patented nanostructured radiating element achieves up to 500% more detection signal!
- ✓ Lower radiating element temperature of 600 °C increases lifetime!
- ✓ Wide wavelength range enables a broad range of applications.

*innovative infrared sources for  
gas detection & spectroscopy*

### Main specifications

| Parameter                     | HIS550R-0          |
|-------------------------------|--------------------|
| Package                       | TO-39 / TO-5       |
| Radiating element area        | 11 mm <sup>2</sup> |
| Radiating element emissivity  | > 0.9              |
| Radiating element temperature | 600 °C at 650 mW   |
| Optical output power          | up to 195 mW       |
| Max. electrical power (DC)    | 700 mW             |
| Max. electrical voltage       | 4.0 V              |
| Max. electrical current       | 175 mA             |
| Electrical resistance         | 21...23 Ω          |
| Modulation frequency*         | 6 Hz               |
| Wavelength range              | 2 to 20 μm         |

\* 50 % modulation depth, square wave signal, 50 % duty cycle

### Optical specifications

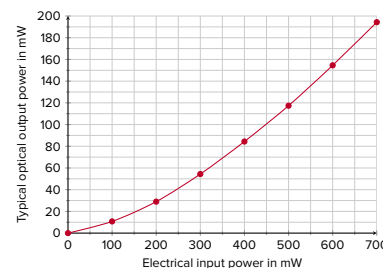
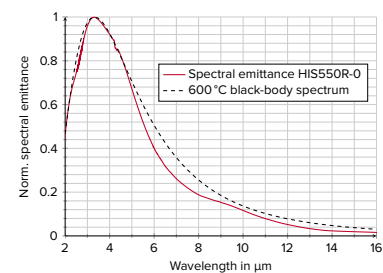

Radiating element temperature

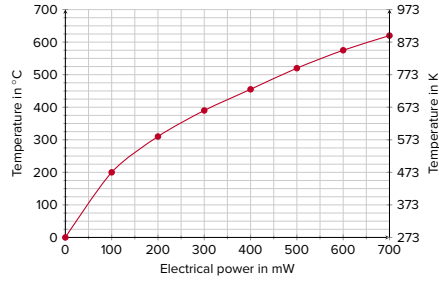

Modulation depth

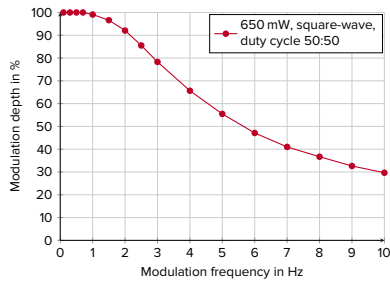

Electrical specifications

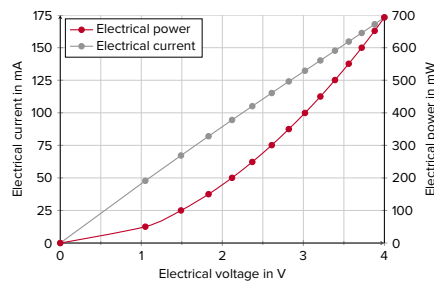

**HIS550R-0**

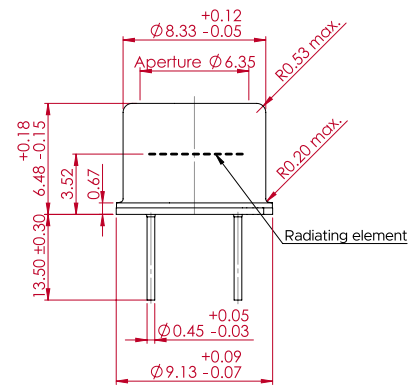
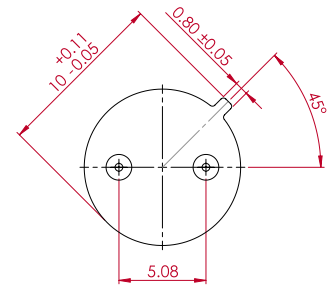

Angular radiation distribution (without window)

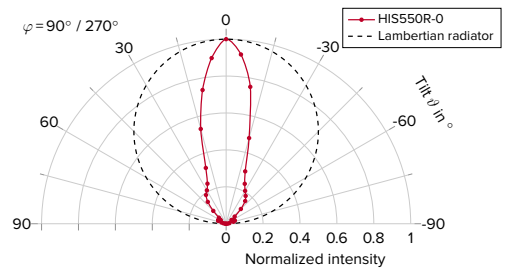
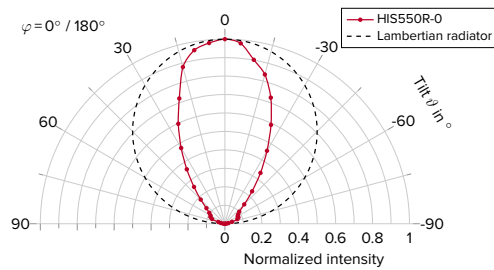
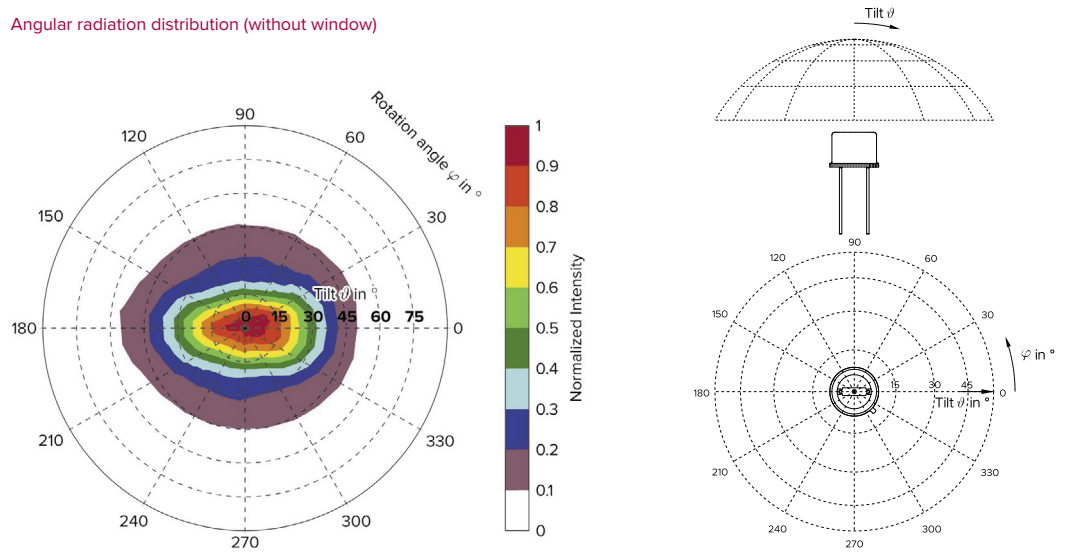

Operating mode recommendation:

All our IR sources can be driven in electrical voltage, current or power regulated mode. The application decides whether the operating mode is DC or AC (pulsed). Depending on the drive mode and the applied electrical power the electrical resistance of the IR emitter can change over time. For highest measurement accuracy a power regulated mode is always recommended for thermal IR emitters. However, it is the most complex operating mode and not suitable in all applications.

For applications that require a small and low-cost driving circuit with a maximum stability we have a technical note with an adjustable low dropout voltage (LDO) regulator.

For further information please refer to: [www.infrasolid.com/technicalnote](http://www.infrasolid.com/technicalnote)