

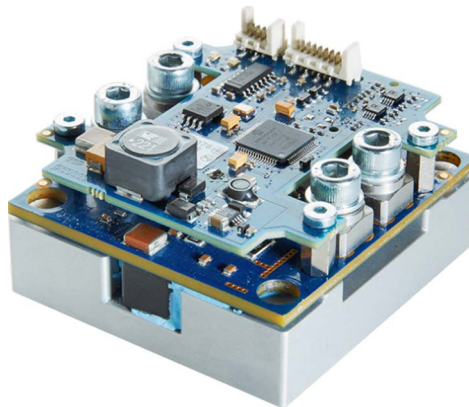

User Manual

LDP-CW 90-10







Rev. 1905

Table of Contents

Please pay Attention to all Safety Warnings!	2
Product Overview	3
Description of Connections	4
How to get started (quick start without PLB-21)	6
How to get started with a PLB-21	6
Dos and Don'ts	7
Absolute Maximum Ratings	7
Ordering Options / Product Changes	7
Functional Description	8
Current Regulator	9
Current Limiter	9
External Setpoint	10
Test Load	10
Power Supply	10
Cooling	10
Overtemperature Shutdown	11
Mechanical Dimensions	11
Power on self test	12
Controlling the driver	12
Controlling the driver using a PLB-21	13
Controlling the driver via a PC	15
The Serial Text Interface	15
The PicoLAS Protocol	15
Description of the Individual Commands	23
Register Description	26

Please pay Attention to all Safety Warnings!

Symbols used in this manual:

-  Risk of electrical hazard
-  Please pay special attention
-  Do not
-  Valuable information, remark



PicoLAS

FOCUSING POWER TO THE POINT

LDP-CW 90-10

Rev. 1905

Fully digital controlled cw Driver for High Power Laser Diodes

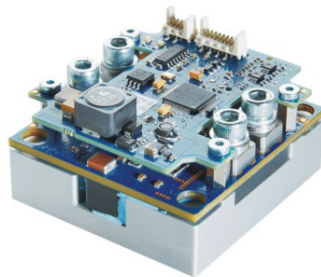

- Output current: 3 .. 90 A
- Compliance voltage: 0 .. 10 V
- Output power: 900 W
- Coverage of cw range
- Analog modulation
- Half brick size (35 cm²)
- Several protective features
- High efficiency

Technical Data*

Output current	3 .. 90 A
Compliance voltage	0 .. 10 V
Current ripple	< 1 %
Ripple frequency	> 1 MHz
Current overshoot	< 1 %
Analog modulation (10 A _{pp})	TBD**
Current settling time (full-scale)	TBD**
Current setpoint input	Analog or digital
Current monitor	TBD**
Voltage monitor	Via RS-232
Supply voltage	24 V DC
Max. power dissipation	65 W
Dimensions in mm	Half brick size 60.9 x 57.8 x 29
Weight	194 g
Operating temperature	0 to +55 °C

* Specifications measured with a fast recovery diode instead of a laser diode. Technical data is subject to change without further notice.
** See manual for further details

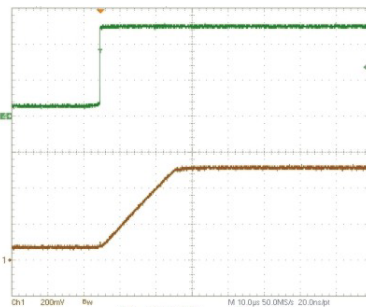

Figure: Soft Start, Current monitor output, scale: 10A/Div

Product Description

The LDP-CW 90-10 is a very affordable, compact and efficient current supply for an output power up to 1 kW.

The capability ranges from continuous output current to analog modulated waveforms like sinusoidal, rectangular or triangular. The modulation is limited usually by the load inductance.

Intended fields of application are laser soldering and welding as well as generic surface treatment and show lasers.

The innovative current regulation concept of the LDP-CW 90-10 produces, compared to the commonly used linear regulation concept, considerably less losses. Hence, only one supply voltage is needed for the control logic and the power stage. The current consumption drawn from the power supply only needs to cover the average laser power and is typically much less than 90 A.

Designed to shield your laser diode from damage, the LDP-CW 90-10 features a number of powerful protective safeguards:

- Innovative current regulation concept actively prevents laser diode from overshoots and overcurrent
- Integrated Soft Start
- Overtemperature shutdown
- Enable/Disable input
- Driver status output
- Protection of the laser diode against reverse currents

Optional Accessories: LDP-C BOB
PLB-21

Description of Connections

All connectors on the LDP-CW 90-10 are protected against ESD as described by the human body model.

The following drawing shows all connections that are available to the user.

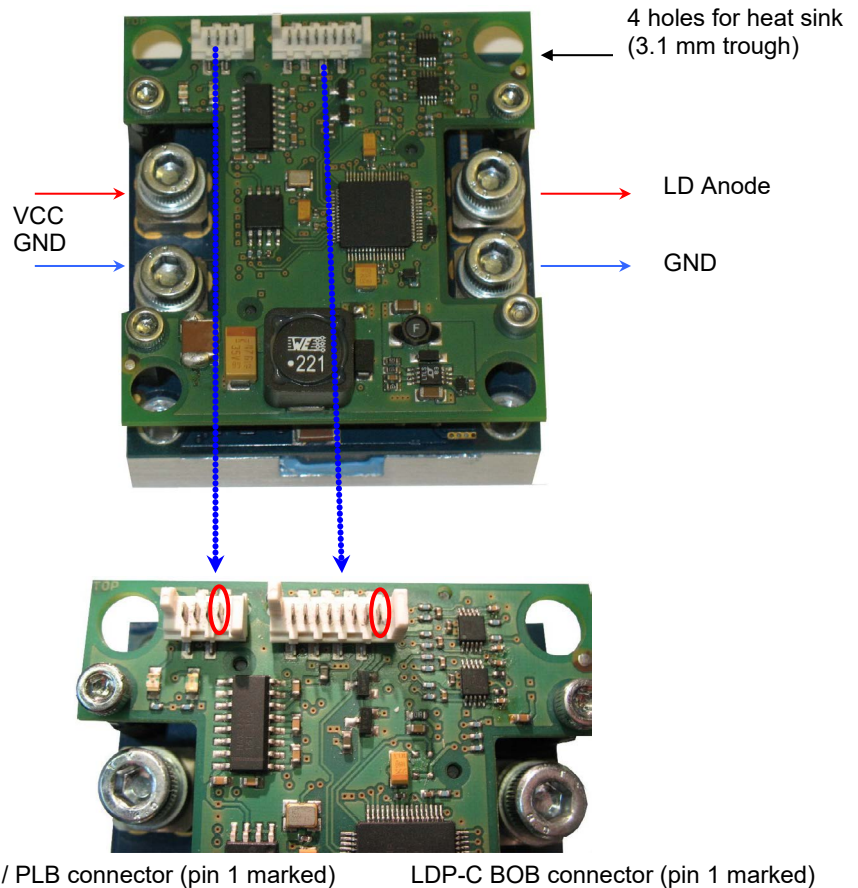

VCC	Supply voltage 24 V
GND (next to Vcc)	Supply ground
LD+	Positive laser diode output (anode)
GND (next to anode on the right side)	Negative laser diode output (cathode) ground. Do not use the input ground!
LDP-C BOB conn.	Mini MOLEX Connector for analog/TTL control of the driver (see below)
RS-232/PLB-21 conn.	Mini-MOLEX Connector for RS-232 communication or the PLB-21 (see below)

Pin assignments and description of the MOLEX-pin header

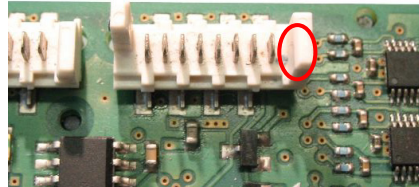

The connector is a MOLEX_908140008, a suitable female connector would be a MOLEX - 90327-0308 like Farnell 673160.

Pin Number	Description	Direction	Comments
1 (marked in red)	reserved		Do not connect!
2	reserved		Do not connect!
3	I-Soll	Input	Scale: depending on configuration
4	Enable-Ext	Input	0 V = disabled, 3.3 V = driver enabled
5	Pulser-Ok ("pulser" is used here as a synonym for driver)	Output	0 V = laser diode driver not ok or power up self test not passed yet; 3.3 V = driver ok / test passed
6	GND	Output	
7	reserved		
8 (right)	+ 3.3 V	Output	Can be used to connect with pin 4 to enable the driver, please use a switch for safety reasons

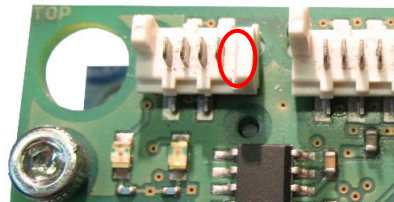

The connector is a MOLEX_908140004, female connector MOLEX - 90327-0304 like Farnell 673146.

Pin Number	Description	Direction	Comments
1 (marked in red)	+12 V	Output	Only for the use with the PLB-21, prevent any overload or short! (max. 100 mA)
2	TXD	I/O	RS-232 standard serial interface
3	RXD	I/O	RS-232 standard serial interface
4 (right)	GND	Output	

How to get started (quick start without PLB-21)

Step	What to do	Note
1	Unpack your device.	
2	Connect a load to the output. Screw connectors are on the right side. Pay attention do the polarity when connecting a diode.	For tests the load might be a resistor or a dummy diode.
3	Apply the supply voltage. Connect the VCC input on the upper left to your power source (fix your wires with the screws at the connector).	Apply supply voltage of +24 V at "VCC" with respect to GND. Make sure there is no voltage surge that could destroy the unit when switching the power supply on!
4	Wait until "pulser-ok" is high ("pulser" is used here as a synonym for driver).	Pin 5 with respect to pin 6 must change from 0 V to 3.3 V.
5	Apply the current setpoint.	
6	Set enable pin "high".	Apply 3.3 V to pin 4 of the BOB connector. The current will ramp up now.
7	Check	If the driver is not properly cooled, it will shut down.

How to get started with a PLB-21

Step	What to do	Note
1	Unpack your device.	
2	Connect the PLB-21.	Use the PLB-21 pin header and the special cable.
3	Apply the supply voltage. Connect the VCC input on the upper left to your power source (fix your wires with the screws at the connector).	Apply any voltage between +12 V and +24 V to "VCC" with respect to GND. The voltage must be at least 5 V higher than the expected compliance voltage of the laser diode. Make sure there is no voltage surge that could destroy the unit when switching the power supply on!
4	Wait until "pulser-ok" is high (pin5). ("pulser" is used here as a synonym for driver.)	Pin 5 with respect to pin 6 must change from 0 V to 3.3 V.
5	Apply the current setpoint.	Use the PLB-21 to switch from external to internal setpoint and set the setpoint by turning the dial.
6	Set enable pin "high" (pin 4).	Apply 3.3 V to pin 4 of the BOB connector. The current will ramp up now.
7	Check	If the driver is not properly cooled, it will shut down.

Dos and Don'ts

Never make a short at the output. This will not do any harm to the laser driver but will result in an incorrect current measurement.

Keep the connection between power supply and driver as well as the connection between driver and laser diode as short as possible.

Mount the driver on an appropriate heat sink. The driver will shut down under overtemperature circumstances. Depending on the desired current a slight airflow across the black coils on top is necessary. Please keep the temperature of these devices below 85 °C.

This driver uses a "high-side" current sensing technique. The GND of the VCC terminal is the same as the GND of the LD terminal.

The driver is for cw operation only.

Never disconnect or connect the load while the driver is operational. This will destroy the driver and / or the connected load.

Make sure that the control ground is connected to the supply ground. Any unexpected current flow through the control board may damage the driver.



Never use the power stage without the assembled controlling unit

Absolute maximum Ratings

- Supply voltage range: +24 V
- Maximum input current: 100 A
- Maximum laser diode output current: 90 A
- Maximum laser diode compliance voltage: 10 V (up to 20 Volts possible, but no support)
- BOB connector input and output voltages: 0 V to 3.3 V (terminals are 5 V proof)
- BOB connector output currents: 1 mA
- Auxiliary 3.3 V supply voltage output current: 30 mA (pin 8 of BOB connector planned for Rev 2.1)
- Auxiliary 12 V supply voltage output current: 100 mA (pin 1 of PLB-21 connector)
- Operating temperature: 0 - 55 °C

Ordering Options / Product Changes

- LDP-CW 90-10 or LDP-CW 90-10-**S50** yields the standard unit with the scaling 5 V = 90 A
- LDP-CW 90-10-**S33**: Input scaling is 0 .. 3.3 V correspond to 0 .. 90 A. The first units were shipped with this scaling. If you require this furthermore, please order with the -S33 option.

Note: This affects the analog input only.

Functional Description

The LDP-CW operates with four parallel buck converters (S1, S2, D1, D2, L1; S3, S4, D3, D4, L2; S5, S6, D5, D6, L3; S7, S8, D7, D8, L4). Every single converter has an independent control loop with a current sensor (I_{meas1}, I_{meas2}, I_{meas3} and I_{meas4}). The setpoint current that is defined by the user is evenly spread over all four converters.

Several security features protect the laser diode and LDP-CW from damage. D10 protects the laser diode from reverse currents while D9 protects the driver in case of a load failure. In case of a failure, the control unit disables the LDP-CW. A soft-start mechanism slowly raises the current after enabling the LDP-CW.

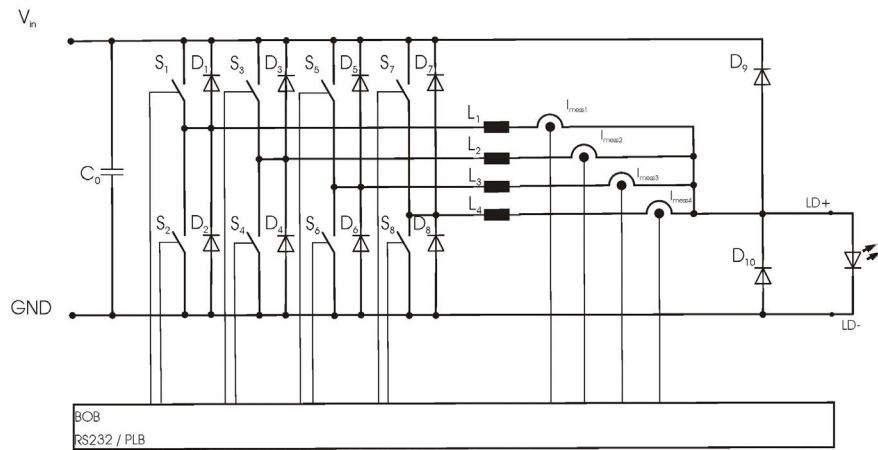

Operation principle of the LDP-CW 90-10 driver

Element	Function
S1, S2, S3, S4, S5, S6, S7, S8, D1, D2, D3, D4, D5, D6, D7, D8, L1, L2, L3, L4	Buck converter
C0	Input buffer capacitor
D9, D10	Laser diode and driver protection diodes

Current Regulator

The LDP-CW 90-10 is equipped with a software controller PI current regulator. The following diagram shows a simplified version of the regulator.

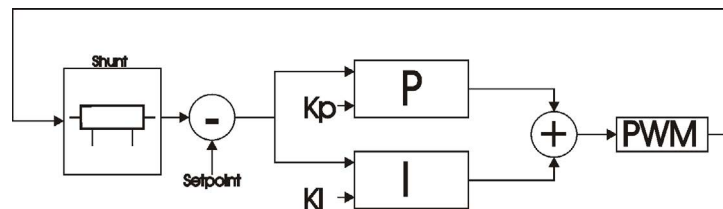

Simplified P-I current regulator

As shown in the diagram, the current regulator is controlled by the parameters K_p and K_i which can be altered by the user. These parameters define the behaviour of the output current. The default values for K_i and K_p supplied by PicoLAS guarantee a safe operation with nearly zero current overshoot, but at a cost of a relative high current settling time and low analog modulation capabilities (~1 ms current setting time and ~500 Hz modulation rate). To achieve the lowest possible setting time - and therefore the highest analog modulation rate - the factory defaults ($K_p = 200$, $K_i = 100$) needs to be adapted to the connected load and the supplied operating voltage.

The current setpoint resolution is 0.1 Ampere.

In order to optimize the regulation behaviour, the customer has to monitor the output current using a high speed current clip on instrument connected to an oscilloscope. It is then possible to monitor the regulators behaviour to the modified parameters.

Please note that if the current regulator has adjusted to its setpoint, the reaction of modified K_i and K_d parameters is pretty low. To achieve correct measurement results the setpoint needs to be altered after modifying the regulator parameters.

Current Limiter

The LDP-CW 90-10 is equipped with a software based current limiter. This can be used to configure a maximum valid current setpoint (analog and digital) which cannot be overstepped.

Please note that this will not protect the load from current overshoots due to wrong P-I parameters!

External Setpoint

An external voltage can be applied to the LDP-CW 90-10 which defines the setpoint current. The scaling of this voltage depends on the version of the driver. See datasheet for more information.

In order to switch between external and internal setpoint the bit 1 of the LSTAT register must be altered. Please note that this only works if the driver is disabled!

The external setpoint can be scaled in two different ways, depending on the state of bit 7 of the LSTAT register:

When this bit is "0" the external setpoint scales between the minimum and maximum current.

When this bit is "1" the external setpoint scales between zero and the maximum current. If a voltage is applied that defines a current which is lower than the valid minimum current, the output is disabled.

The external setpoint voltage is converted by an analog to digital converter into a digital value. The resolution of this converter is 10 bit. This may lead to some current jitter as this resolution is not equal to the current resolution $0x 0.1$ ampere.

The input impedance on this input pin is greater or equal to 10 kohms.

Test Load

A common method to test the driver is to connect a regular silicon rectifier diode to the driver output. Attention has to be paid to the junction capacitance of the diode. Only fast recovery diodes (or similar) have a low parasitic capacitance as laser diodes have. To achieve reasonable test results - especially when you plan to use the driver with AM modulation - the parasitic elements of the test diode and the connection must be very similar to a laser diode approach. Regular silicon rectifier diodes have a junction capacitance of several microfarads and are not a suitable test load! The use of these diodes will yield in incorrect current measurement at the pulse edges!

Power Supply

The power supply must be able to cover the output power plus the internal power losses (please see next section).

Cooling

The driver produces up to 65 W of losses. Thus, the base plate has to be mounted on a heat sink to ensure proper operation and prevent an overtemperature shutdown.

Overtemperature Shutdown

To protect itself, the LDP-CW automatically shuts down if its temperature rises above 80 °C. This condition is latched and the appropriate bit in the ERROR register is set. To re-enable the LDP-CW the ENABLE pin must be toggled (set low and then high).

Mechanical Dimensions

All dimensions are in millimetres (mm).

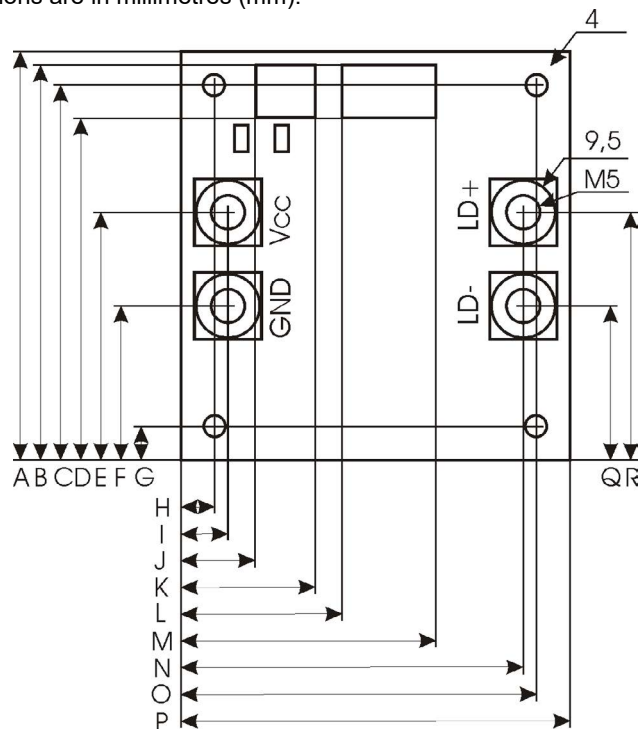

Position (vertical)	Dimension (mm)	Position (horizontal)	Dimension (mm)
A	61	H	4.8
B	59.6	I	6.6
C	55.9	J	9.3
D	51.7	K	18.3
E	38.1	L	20.6
F	22.8	M	34.7
G	5.1	N	51.2
Q	24.13	O	53
R	36.8	P	57.9

Power on Self Test

Each time the driver is powered up, it performs a test of its internal safety features. The driver cannot be enabled until a self test has been performed successfully. The PULSER_OK signal will be pulled high when the test has been successful.

The test will take less than 5 seconds, but can take up to 15 seconds due to internal time-outs if any failures are detected.

Controlling the Driver

The driver can be operated stand alone, with a PLB-21 or a PC connected to it via a serial link (RS-232 interface, for USB you need an USB RS-232 adaptor). It remembers all settings from the last time it had been powered on, unless configured to load default values on power-on. In latter case it loads pre-configured settings each time the power is applied. Connecting a digital control to the driver does not alter the internal settings.

No digital control (factory default)

If no digital control (PLB-21 or serial link to PC) is attached, only the BOB connector could be used to control the driver. If configured so, the pin 10 at the BOB connector ("I_{setpoint}") can be used to control the setpoint current. To enable the output pin 7 at the BOB connector ("ENABLE") must be set HIGH. If an error occurs (e.g. overtemperature), the driver will be disabled and the pin 1 of the BOB connector ("PULSER_OK") is pulled low. The "enable" pin has to be toggled to enable the driver again.

PLB-21

If a PLB-21 is attached to the driver, it can be used to control the behavior of the driver. The PLB-21 may ask for a driver to download. This must be confirmed with "yes" in order for the PLB-21 to work properly. This must always be done when the PLB-21 was connected to any other PicoLAS product. After the download all operating parameters can be accessed using the PLB-21. For a detailed description see chapter PLB-21 below.

RS-232

If the driver is connected to a PC using a serial cable, all operating parameters can be accessed via a serial RS-232 terminal program or the PicoLAS protocol. The PLB-21 is automatically disabled if a serial connection is established. For a detailed description of the serial text protocol and the PicoLAS protocol see below.

PC

If the driver is connected to a PC, all operating parameters can be accessed via a serial RS-232 terminal program or the PicoLAS protocol. For a detailed description of the serial text protocol and the PicoLAS protocol see below.

Controlling the driver using a PLB-21

When the PLB-21 is connected the first time to the LDP-CW 90-10 driver, the user is asked to download a new firmware driver. This must be confirmed with “yes” in order for the PLB-21 to work properly.

Menu Structure

The following diagram shows the structure of the PLB-21 menu which affects the driver. All entries are described in detail. All other menu entries are described in the PLB-21 manual. For detailed instructions see the PLB-21 manual.

Menu root

- Setpoint
 - o Cur(ext/int)F₁
 - o Cur Limit
- Regler (controller)
 - o P
 - o I
- Config
 - o Enable Ext
 - o Enable
 - o I scale
- Temp
 - o Temp Off
 - o Temp
- Defaults
 - o Def. pwr on
 - o Load defaults
 - o Save defaults

Setpoint

In this menu the setpoint current can be modified.

Cur (ext/int) F₁

This value defines the setpoint current. It can be switched between internal (int) and external (ext) setpoint by pressing the F₁ key.

When using the internal setpoint, the value can be modified by the user.

When using the external setpoint, the value shown is measured value supplied at pin 3 of the BOB connector. The display is updated every few seconds, so it is not accurate when using analog modulation.

Cur Limit

This value defines the software current limitation value. Please see section “Current Limiter” for more details.

Regler (controller)

The LDP-CW 90-10 implements a PI control loop (that controls the current). The control parameters P and I can be altered within this submenu. Please see section "Current Regulator" for more details.

Config

The LDP-CW 90-10 can be configured to use a software enable signal instead of the hardware Ppin of the BOB connector. This can be configured here.

Enable Ext.

When this item is set to "on", the LDP-CW 90-10 uses the hardware enable pin of the BOB connector. Otherwise it uses the menu point below.

Enable

When "Enable Ext" is set to "off" the LDP-CW 90-10 becomes enabled when this item is set to "on". Otherwise this shows the state of the ENABLE pin of the BOB connector.

I scale

When enabled, the external current setpoint reaches from zero to the configured current limiter value, otherwise it reaches from the minimum current to the configured limit.

Temp

The LDP-CW 90-10 is equipped with an onboard temperature sensor. The actual measured temperature of the PCB as well as the shutdown temperature can be monitored here.

Defaults

The driver can load a default setting each time it powers up or the user commands it to do so. This is done within this submenu.

Def. pwron

When enabled, the driver loads the saved settings each time it powers up.

Load

When activated via turning the Jogdial or the ENTER key all internal registers are changed to the previously saved values. The output stage has to be re-enabled via the L_ON bit or the FIRE Key afterwards

Save

When activated via turning the Jogdial or the ENTER key all internal registers are stored into an internal EEPROM for later usage.

If an Error occurs

If an error occurs during operation the pulse output is switched off, the “pulser_ok_ext” signal on the BOB connector is pulled low and a message is displayed on the PLB-21. If no other action is described on the display, a toggle of the ENABLE pin resets the error condition and re- enables the driver.

Controlling the driver via a PC

Introduction

When the LDP-CW is connected to a PC, it allows communications over a serial text interface as well as the PicoLAS protocol. While the text interface is designed for communication with a terminal program, the PicoLAS protocol is designed as a system interact protocol.

The switching between the two protocols occurs automatically as soon as the driver receives a certain sequence. The corresponding commands are:

- **PING** for the PicoLAS protocol
- **“init”** followed by <Enter> for the text interface

Description of the RS-232 Interface

The LDP-CW 90-10 implements a standard RS-232 interface. It can be connected to a PC using a three-wire connection. For USB connection you need a USB RS-232 adaptor (USB-serial adapter).

The connection settings are:

Baud rate	115200
Data bits	8
Stop bits	1
Parity	even

The Serial Text Interface

The following section describes the structure and the commands of the text interface.

Structure

Every command that is sent to the LDP-CW must be completed with a CR (Carriage Return = Enter). It consists of a command word followed by one or more parameters. If the command has been executed successfully a "00" is sent, otherwise a "01". If there is an error pending, the response will be "10", otherwise "11". If the command requires an answer parameter, this parameter is sent before the confirmation is given.

Example 1:

The user would like to read out the actual setpoint current:

```
User input:          gcur<Enter>
Output of the LDP-CW: 12.25<CR><LF>
                      00<CR><LF>
```

Example 2:

The user would like to set a new setpoint current:

```
User input:          scur 25.7<Enter>
Output of the LDP-CW: 25.7<CR><LF>
                      00<CR><LF>
```

Input is done in ASCII code and is case sensitive. Every terminal can be used which supports this standard.

Commands for the LDP-CW

The following table contains a command reference for the LDP-CW.

Command	Parameter	Answer	Description
scur	Current in A	--	Sets the pulse current to the indicated value. A dot is used as decimal point. No more then one decimal place is used! (12.225 is the same as 12.2)
gcur	--	Current in A	Outputs the present output current
gcurmin	--	Current in A	Outputs the minimum output current
gcurmax	--	Current in A	Outputs the maximum output current
scurnosave	Current in A	Current in A	Same as scur, but not saved
scurlimit	Current in A	Current in A	Sets the current limiter to the given value in A. A dot is used as decimal point. No more then one decimal place is used! (12.225 is the same as 12.2)
gcurlimit	--	Current in A	Outputs the actual current limiter value
gcurlimitmin	--	Current in A	Outputs the minimum current limiter value
gcurlimitmax	--	Current in A	Outputs the maximum current limiter value
on	--	--	Activates the output
off	--	--	Deactivates the output
curext	--	--	Use external current setpoint
curint	--	--	Use internal current setpoint
slstat	32 bit number	--	Sets the LSTAT register to the value
glstat	--	32 bit number	Outputs the LSTAT register
gserial	--	serial number	Returns the device serial number
gname	--	device name	Returns the devices internal name
ghwver	--	hardware version	Prints out the hardware version
gswver	--	software version	Prints out the software version
ps	--	current settings	Prints out an overview of all settings
loaddefault	--	--	Loads previously saved settings
savedefault	--	--	Saves the current settings as defaults
enautoload	--	--	Enables the autoloading feature
disautoload	--	--	Disables the autoloading feature
sp	32 bit number	--	Sets the parameter of the P-controller
gp	--	P value	Returns the parameter of the P-controller

Command	Parameter	Answer	Description
gpmin	--	minimum P value	Returns the minimum parameter of the P-controller
gpmax	--	maximum P value	Returns the maximum parameter of the P-controller
si	32 bit number	--	Sets the parameter of the I-controller
gi	--	I value	Returns the parameter of the I-controller
gimin	--	minimum I value	Returns the minimum parameter of the I-controller
gimax	--	maximum I value	Returns the maximum parameter of the I-controller
gtemp	--	Temperature in °C	Returns the actual device temperature
gtempoff	--	Temperature in °C	Returns the temperature at which the device will shut down
gtempphys	--	Temperature in °C	Returns the temperature at which the device will restart after thermal shutdown
gtempwrn	--	Temperature in °C	Returns the temperature at which the device will warn about reaching its thermal limit
enable_int	--	--	Switches the enable control to internal (software)
enable_ext	--	--	Switches the enable control to external
gadcudiode	--	Voltage in [V]	Returns the actual measured compliance voltage
gadcvc	--	Voltage in [V]	Returns the actual measured supply voltage
enable	--	--	Enables the driver (when enable control is switched to internal)
disable	--	--	Disables the driver (when enable control is switched to internal)
ext_scale	0 or 1	--	Sets the external (analog) setpoint scaling to min .. max ("0") or 0 .. max ("1")

If an Error Occurs

If an error occurs during operation the driver output is switched off and the return value of a command is no longer "00" or "01" but "10" or "11". Errors have to be acknowledged with a toggle of the ENABLE signal (switch off and on again), otherwise switching on again of the LDP-CW output is not possible. For more details see the description of the ERROR register.

To retrieve the error, use the **gerr** command for the content of the ERROR register or the **gerrtxt** command for a human readable form.

The PicoLAS Protocol

The following section describes the structure and valuable commands of the PicoLAS protocol.

Structure

Each transmission consists of 12 bytes – called a frame in the following – that must be sent consecutively. Otherwise the system times out and the transmission must start again from the beginning.

A frame has a fixed structure. The first two bytes describe the command, the following eight bytes the parameters, followed by one reserved byte and one checksum byte. The checksum is calculated out of the first 11 bytes that are linked by a bitwise XOR.

Thus a frame has the following structure:

Byte	Meaning
1	Bit 8-15 of the command
2	Bit 0-7 of the command
3	Bit 56-63 of the parameter
4	Bit 48-55 of the parameter
5	Bit 40-47 of the parameter
6	Bit 32-39 of the parameter
7	Bit 24-31 of the parameter
8	Bit 16-23 of the parameter
9	Bit 8-15 of the parameter
10	Bit 0-7 of the parameter
11	Reserved, always 0x00
12	Checksum

A properly received frame must be acknowledged by the recipient with an answer that is also a frame. If the acknowledgement does not occur the command has not been processed and the sending procedure should be repeated.

If the recipient recognizes the command as valid, but not the parameters, it will answer with an ILGLPARAM (0xFF12) as command.

In the case the recipient receives an invalid command it will answer with UNCOM (0xFF13).

If a faulty checksum is recognized, the answer is RXERROR (0xFF10). If this error occurs often, the connection should be checked.

Using the REPEAT (0xFF11) command the recipient can instruct the sender to send the most recent frame again.

General Commands

The following list contains an overview of the general commands that are supported by every product from PicoLAS making use of this protocol. The explanation of the individual commands is given further below.

Command Name	Sent Frame		Answer Frame	
	Command	Parameter	Command	Parameter
PING	0xFE01	0	0xFF01	0
IDENT	0xFE02	0	0xFF02	ID
GETHARDVER	0xFE06	0	0xFF06	Version
GETSOFTVER	0xFE07	0	0xFF07	Version
GETSERIAL	0xFE08	0 ... 20	0xFF08	Refer to description
GETIDSTRING	0xFE09	0 ... 20	0xFF09	Refer to description

PING

This command is used to determine the presence of a connected driver and to initialize its interface. It does not change any registers. The command parameter is always 0, the answer parameter as well.

IDENT

This command is used to determine the device ID of an attached recipient. It has no effect on the condition of the recipient. The parameter is always 0. The answer contains the ID.

GETHARDVER

Instructs the driver to send the version number of its hardware. The parameter is always 0. The answer contains the hardware version number. The format of the answer is: 0x000000<major><minor><revision>. In other words: one byte for each of the three elements of the version number.

As example, version 1.2.3 has the parameter 0x000000010203.

GETSOFTVER

Instructs the driver to send the version number of its firmware. The parameter is always 0.

The answer contains the software version of the recipient. The format of the answer is: 0x000000<major><minor><revision>. In other words: one byte for each of the three elements of the version number.

As example, version 2.3.4 has the parameter 0x000000020304.

GETSERIAL

Instructs the driver to send its serial number. If 0 is sent as parameter, the answer contains the number of (ASCII) digits of the serial number. Otherwise the respective position of the serial number is sent in ASCII format.

GETIDSTRING

Instructs the driver to send its name. If 0 is sent as parameter, the answer contains the number of digits of the string. Otherwise the respective position of the serial number is sent in ASCII format.

Commands for the Driver

The following table contains a list of the commands which the LDP-CW supports in addition to the generally applicable commands. An explanation of the individual commands and its parameters follows afterwards.

Command	Sent Frame		Received Frame	
	Command	Parameter	Command	Parameter
GETTEMP	0x0001	0	0x0100	16 bit signed integer
GETTEMP1	0x0002	0	0x0100	16 bit signed integer
GETTEMP2	0x0003	0	0x0100	16 bit signed integer
GETTEMP3	0x0004	0	0x0100	16 bit signed integer
GETTEMPOFF	0x0005	0	0x0100	16 bit signed integer
GETTEMPHYS	0x0007	0	0x0100	16 bit signed integer
GETLSTAT	0x0010	0	0x0110	32 bit unsigned integer
SETLSTAT	0x0011	Refer to description	0x0110	32 bit unsigned integer
GETERROR	0x0020	0	0x0120	32 bit unsigned integer
GETCUR	0x0030	0	0x0130	16 bit unsigned integer
GETCURMIN	0x0031	0	0x0130	16 bit unsigned integer
GETCURMAX	0x0032	0	0x0130	16 bit unsigned integer
SETCUR	0x0033	Refer to description	0x0130	16 bit unsigned integer
GETCUREXT	0x0034	0	0x0130	16 bit unsigned integer
GETCURLIMIT	0x0038	0	0x0130	16 bit unsigned integer
GETCURLIMITMIN	0x0039	0	0x0130	16 bit unsigned integer
GETCURLIMITMAX	0x003A	0	0x0130	16 bit unsigned integer
SETCURLIMIT	0x003B	Refer to description	0x0130	16 bit value

Command	Sent Frame		Received Frame	
	Hex	Description	Hex	Data
SETCURNOSAVE	0x003C	Refer to description	0x0130	16 bit value
GETKPMIN	0x0040	0	0x0140	32 bit signed integer
GETKPMAX	0x0041	0	0x0140	32 bit signed integer
GETKP	0x0042	0	0x0140	32 bit signed integer
SETKP	0x0043	Refer to description	0x0140	32 bit signed integer
GETKIMIN	0x0044	0	0x0140	32 bit signed integer
GETKIMAX	0x0045	0	0x0140	32 bit signed integer
GETKI	0x0046	0	0x0140	32 bit signed integer
SETKI	0x0047	Refer to description	0x0140	32 bit signed integer
LOADDEFAULT	0x0050	0	0x0150	0
SAVEDEFAULT	0c0051	0	0x0150	0
GETADCUDIODE	0x0060	0	0x0160	16 bit unsigned integer
GETADCIDIODE	0x0061	0	0x0160	16 bit unsigned integer
GETADCVCC	0x0062	0	0x0160	16 bit unsigned integer
GETADCPH	0x0063	0 ... 3	0x0160	16 bit unsigned integer

Description of the Individual Commands

GETTEMP

The return value contains the actual measured temperature of the driver. It represents the maximum of the tree individual sensors, which can also be monitored. It is scaled in 0.1 °C.

GETTEMP1

The return value contains the actual measured temperature of the first temperature sensor. It is scaled in 0.1 °C.

GETTEMP2

The return value contains the actual measured temperature of the second temperature sensor. It is scaled in 0.1 °C.

GETTEMP3

The return value contains the actual measured temperature of the third temperature sensor. It is scaled in 0.1 °C.

GETTEMPOFF

The return value contains the overtemperature shutdown border. If the driver reaches this temperature, it will shutdown itself. It is scaled in 0.1 °C.

GETTEMPHYS

The return value contains the temperature to which the driver must cool down before it can be re-enabled. It is scaled in 0.1 °C.

GETLSTAT

This command returns the value of the LSTAT register. For a complete description of this register see below.

SETLSTAT

This command sets the LSTAT register to the given value. The return value contains the new register value.

GETERROR

This command returns the value of the ERROR register. For a complete description of this register see below.

GETCUR

The return value contains the actual setpoint value in steps of 0.1 A.

GETCURMIN

The return value contains the minimum setpoint value in steps of 0.1 A.

GETCURMAX

The return value contains the maximum setpoint value in steps of 0.1 A.

SETCUR

This command sets the current setpoint to the given value in steps of 0.01 A. The value must be within the borders defined by the minimum and maximum current values given by the *GETCURMIN* and *GETCURMAX* command. The return value contains the actual setpoint value.

GETCUREXT

The return value contains the measured and converted value of the external analog setpoint in steps of 0.01 A.

GETSOLLIMIT

The return value contains the actual configured current limiter value in steps of 0.1 A.

GETSOLLIMITMIN

The return value contains the minimum current limiter value in steps of 0.1 A.

GETSOLLIMITMAX

The return value contains the maximum current limiter value in steps of 0.1 A.

SETSOLLIMIT

This command sets the current limiter to the given value in steps of 0.01 A. The value must be within the borders defined by the minimum and maximum current values given by the *GETCURLIMITMIN* and *GETCURLIMITMAX* command. The return value contains the actual current limiter value.

SETSOLLNOSAVE

Same as *SETCUR*, but does not save the new value into the internal EEPROM. The execution time of this command is significantly faster.

GETKPMIN

The return value contains the minimum value of the P-controller.

GETKPMAX

The return value contains the maximum value of the P-controller.

GETKP

The return value contains the maximum value of the P-controller.

SETKP

This command sets the value of the P-controller to the given value. The value must be within the borders defined by the minimum and maximum current values given by the *GETKPMIN* and *GETKPMAX* command. The return value contains the actual value.

GETKIMIN

The return value contains the minimum value of the I-controller.

GETKIMAX

The return value contains the maximum value of the I-controller.

GETKI

The return value contains the maximum value of the I-controller.

SETKI

This command sets the value of the I-controller to the given value. The value must be within the borders defined by the minimum and maximum current values given by the *GETKIMIN* and *GETKIMAX* command.

The return value contains the actual value.

SAVEDEFAULTS

This command saves all settings to an internal EEPROM.

LOADDEFAULTS

This command loads previously saved settings into the driver.

GETADCUDIODE

The return value contains the actual measured compliance voltage of the connected load. It is measured in steps of 0.1 V.

GETADCIDIODE

The return value contains the actual measured output current of the driver. It is measured in steps of 0.1 A. Please note that this is not an independent measurement and cannot be used to verify the output current.

GETADCVCC

The return value contains the actual measured supply voltage. It is measured in steps of 0.1 V.

GETADCPH

The return value contains the actual measured output current of the given phase. It is measured in steps of 0.1 A. Please note that this is not an independent measurement and cannot be used to verify the output current. It can be used to make sure that all four phases of the driver are working properly.

Register Description

Description of the LSTAT Register

The following list contains a description of the individual LSTAT bits. These can be read with GETLSTAT and written with SETLSTAT. With SETLSTAT a complete 32 bit word must always be written. Thus, to change individual bits, first the register must be read out with GETLSTAT, and then the desired bits changed and finally passed back to the LDP-CW with SETLSTAT.

Bit	Name	Read/Write	Meaning
0	L_ON	Read/Write	Switch on/off the pulse output. Note that this bit is automatically set high every time the driver is powered on.
1	ISOLL_EXT	Read/Write	When "1" the external setpoint current is used. Only modifiable when ENABLE_OK is "0".
2	ENABLE_OK	Read(/Write)	When bit 6 is set to "1" this bit indicates that the external enable is given. (Read only) When bit 6 is set to "0", this bit determines weather the driver is enabled ("1") or disabled ("0"). (Read/Write)
3	PULSER_OK	Read	Indicates that the driver is in no error condition.
4	DEFAULT_ON_PWRON	Read/Write	When "1" the driver will load the default values at each power-up.
5	Reserved	Read	Reserved
6	ENABLE_EXT	Read/Write	Determines weather the driver is enabled via the ENABLE pin of the BOB connector ("1") or via the ENABLE bit in this register ("0").
7	ISOLL_EXT_SCALE	Read/Write	Defined weather the external setpoint voltage ranged from min .. max. current ("0") or from zero to max. ("1"). Note: Available since version 1.0.3
8-31	Reserved	Read	Reserved

Description of the ERROR Register

The following list contains a description of the individual bits in the ERROR register. If the bit is a "1" it will deactivate the unit output.

The bits 1-3 and 5 are set during the power on self test. They can not be cleared by the ENABLE pin or the CLEARERROR command. If one of these bits is set, the supply voltage should be switched off and on again. If the error persists, the driver needs to be repaired.

Bit	Name	Read/Write	Meaning
0	VCC_FAIL	Read	Indicates an overtemperature shutdown of the output stage.
1	CRC_CONFIG_FAIL	Read	Indicates that the internal configuration register is corrupt. If this error persists, the LDP-CW needs to be repaired.
2	CRC_DEFAULT_FAIL	Read	Indicates that the internal default registers are corrupt. The default values should be re- saved.
3	CRC_DEVDRV_FAIL	Read	Indicates that the internally stored PLB-21 driver is invalid. The driver can still be used, but it is impossible to download the driver into the PLB-21.
4	Reserved	Read	Reserved
5	CRC_CAL_FAIL	Read	Indicates that the internal calibration registers are corrupt. If this error persists, the LDP-CW needs to be repaired.
6	Reserved	Read	Reserved
7	FAILED_TO_LOAD_DEFAULTS	Read	Indicates that the last attempt to load the default values failed.
8	TEMP_OVERSTEPPED	Read	Indicates that the maximum operating temperature was overstepped.
9	TEMP_HYSTERESIS	Read	Indicates that the driver is cooling down after an overtemperature shutdown. The driver cannot be re-enabled until this bit flips back to "0".
10	TEMP_WARNING	Read	Indicates that the operation temperature is near the shutdown temperature.
11	I2C_EEPROM_FAIL	Read	Indicates that there is an internal I2C bus error. If this error persists after a power cycle the device must be repaired.

Bit	Name	Read/Write	Meaning
12	ENABLE_DURING_POWERON	Read	Indicates that the ENABLE pin of the BOB connector was high during power-on. Only valid if ENABLE_EXT the LSTAT register is set to "1".
13	ENABLE_DURING_ENCHANGE	Read	Indicates that the ENBLE pin of the BOB connector was high while setting ENABLE_EXT to "1" in the ENABLE register.
14	Reserved	Read	Reserved
15	PID_MAX_ERROR	Read	This indicates that the internal PI controller has reached its maximum duty cycle and was unable to reach the programmed setpoint current. Check if the load is connected properly and the compliance voltage is 5 Volts lower than the supply voltage. Note: Available since version 1.0.4
16	IIST_ERROR	Read	This indicates that the output current was outside safe areas. This may happen if the supply voltage can not deliver enough power or if the PI values are wrong. Note: Available since version 1.0.4
17-31	Reserved	Read	Reserved