

1mm Active Area InGaAs PIN Photodiode PDINDP Series

NECSEL IP offers a variety of standard and custom large active area InGaAs PIN Photodiodes in fiber coupled packages. These semiconductors are of proven manufacture and design. InGaAs is optimal from 1000 to 1650nm. All devices are available in fiber pigtailed co-axial packages or in connector style receptacle packages.

Pigtailing

Devices can be pigtailed with any size optical fiber that is compatible with its active area size. Pigtails may range in core size from 3 um to 200 micron. One meter is the standard length, but any length or connector termination may be specified. Pigtails may be terminated with ST, FC, SC and LC connectors with either PC or APC polish.

Receptacles

Standard ST, FC and SC housings are available in both panel and board mountable versions. These receptacles can be optimized for use with both single mode and multimode optical fibers.

RoHS Compliant



Applications

- Digital and analog optical communications
- Optical LAN
- OTDR
- Power meters

Manufacturing

NECSEL maintains a large inventory of the most popular detector sizes and pin-outs. Efficient package designs and manufacturing processes allow NECSEL to rapidly support both small and large volume requirements. Complete 100% testing of all critical parametric device values ensure optimal performance and quality. Not all receptacle packaging styles are represented on this data sheet, so please contact NECSEL for specific needs.

PDINDP Series 1mm Diameter InGaAs PIN Photodiode					
Parameter	Unit	Min.	Typical	Max	Test Conditions
Wavelength	nm	1000		1650	
Diameter	mm		1.0		
Responsivity	A/W	0.85	0.90	1.1	V _r =5V 1550nm
Responsivity with Optional 10dB ND Filter	A/W	0.085	0.090	0.110	V _r = 5V 1550nm
Dark Current	nA		0.7	2.5	V _r =5V, T _c =25°C
Capacitance	pF		30	70	V _r =5V, 1MHz
Shunt Resistance	M Ohm	10	100		V _r =10mV
Bandwidth	MHz	30	50		V _r =5V

NECSEL reserves the right to make modifications to or discontinue products without prior notice.

1mm InGaAs 08-21 REV B

1mm Active Area InGaAs PIN Photodiode PDINDP Series

Fiber Pigtailed Assembly

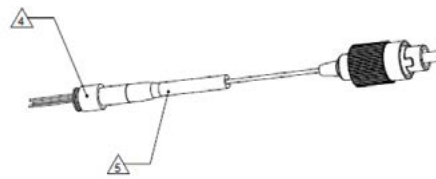
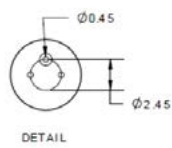

NOTES:

- 1 THESE DEVICES ARE ESD SENSITIVE. ESD PRECAUTIONS ARE ADVISED.
- 2 ALL DEVICES ARE SHIPPED WITH ESD LEAD PROTECTORS AND DUST COVERS.
- 3 ALL DEVICES WILL BE MARKED WITH A PD-LD SERIAL NUMBER.

- 4 303SS
- 5 SILICONE RUBBER, RED

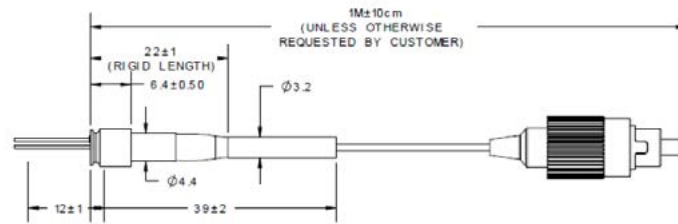
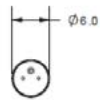

NECSEL reserves the right to make modifications to or discontinue products without prior notice.

1mm InGaAs 08-21 REV B

1mm Active Area InGaAs PIN Photodiode PDINDP Series

Pinout & Mechanical Dimensions (mm)

Mechanical Drawing FC Receptacle Panel Mount PIN Photodiode PDINDP1.0FC1A-T-0

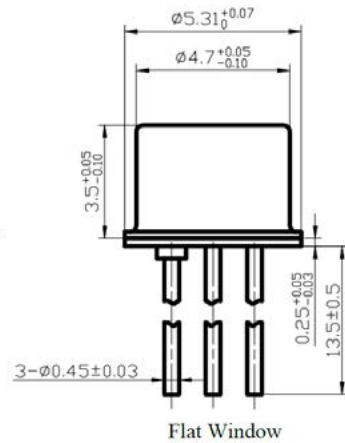

TO-46 Sub-assembly Drawing with pin-out

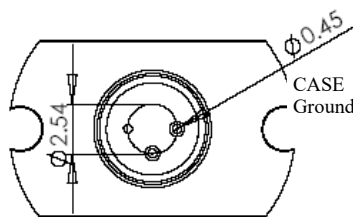
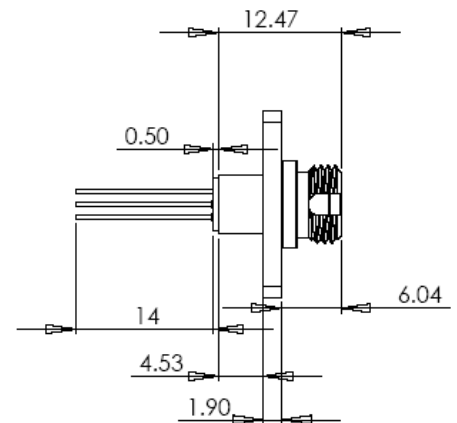
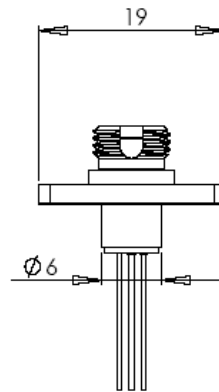
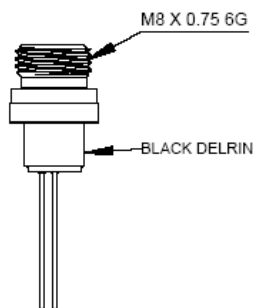
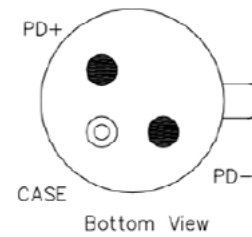

DETAIL A
SCALE 4 : 1

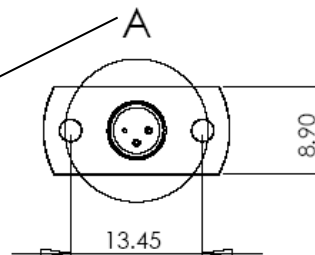

NOTES:

1. THESE DEVICES ARE ESD SENSITIVE. ESD PRECAUTIONS ARE ADVISED.
2. ALL DEVICES ARE SHIPPED WITH ESD LEAD PROTECTORS AND DUST COVERS.
3. ALL DEVICES WILL BE MARKED WITH A PD-LD SERIAL NUMBER.

NECSEL reserves the right to make modifications to or discontinue products without prior notice.

1mm InGaAs 08-21 REV B

1mm Active Area InGaAs PIN Photodiode PDINDP Series

PDINDP1.0UN11-T-0

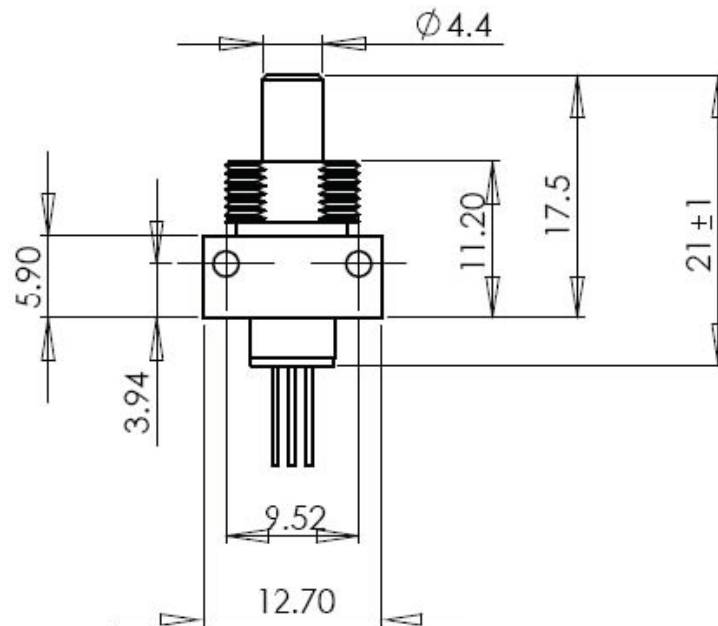
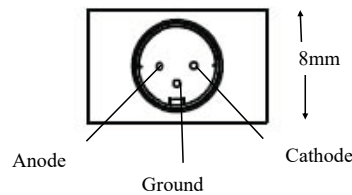
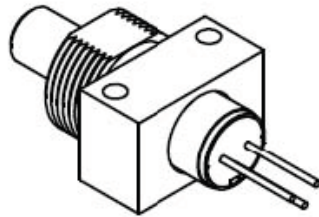

NECSEL reserves the right to make modifications to or discontinue products without prior notice.

1mm InGaAs 08-21 REV B

1mm Active Area InGaAs PIN Photodiode PDINDP Series

SC2 Style Board / Panel Mount
Receptacle with "W" Lead Orientation

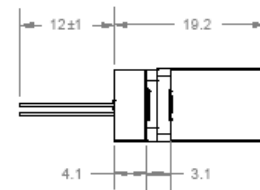
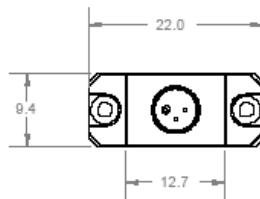
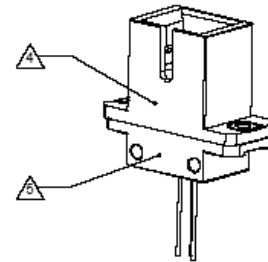
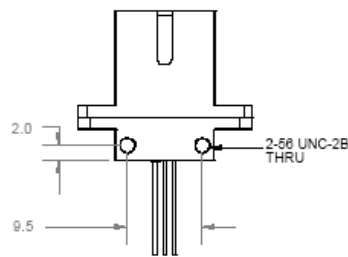

InGaAs Absolute Maximum Ratings (T_c=25°C)

Parameter	Symbol	Value	Unit
Reverse Voltage	V _R	30	V
Forward Current	I _F	10	mA
Reverse Current	I _R	5	mA
Operating Temperature	T _{OPR}	-40 to 85	°C
Storage Temperature	T _{STR}	-40 to 85	°C
Input Optical Power	P	10	mW
Soldering Temperature		260/10	°C/sec

NECSEL reserves the right to make modifications to or discontinue products without prior notice.

1mm InGaAs 08-21 REV B

1mm Active Area InGaAs PIN Photodiode PDINDP Series

Dark Current - Reverse Voltage

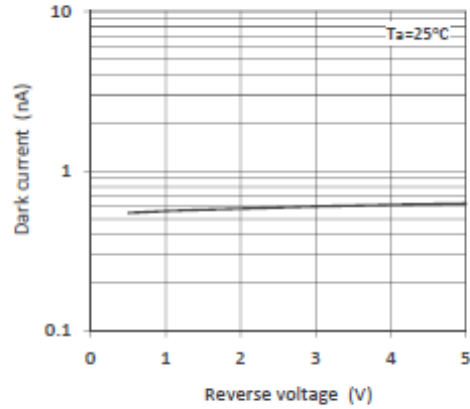

Spectral Responsivity

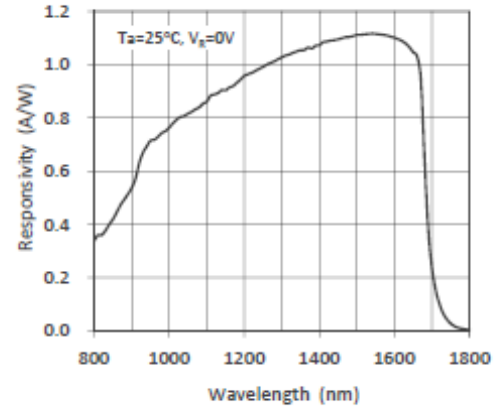

Capacitance - Reverse Voltage

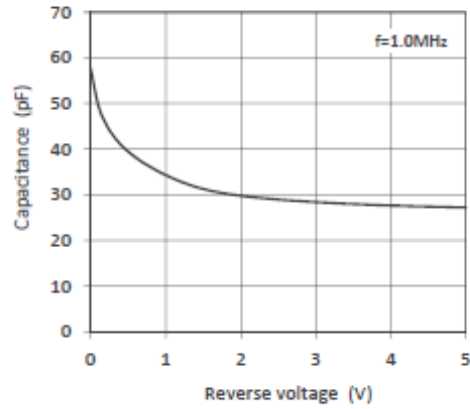

NECSEL reserves the right to make modifications to or discontinue products without prior notice.

1mm InGaAs 08-21 REV B