

iC-WK, iC-WKL 2.4 V CW LASER DIODE DRIVER

Rev D2, Page 1/10

FEATURES

- ◆ iC-WK MSOP8 AEC-Q100 qualified (Grade 3)
- ◆ CW operation up to 90 mA from 2.4 to 6 V supply voltage
- ◆ Rapid soft start after power-on typical within 70 μ s
- ◆ Simple power adjustment via the external resistor
- ◆ Control loop accuracy better than 1% with changes in temperature, supply voltage and load current
- ◆ Integrated reverse polarity protection for the iC and laser diode
- ◆ Strong suppression of transients with very small external capacitors; integrated flyback path
- ◆ Permanent shutdown with excessive temperature and overcurrent (i.e. if the laser diode is damaged or the feedback current path fails)
- ◆ Two feedback inputs permit all current LD types to be used (N/P/M configurations)
- ◆ Modulation via the feedback inputs is possible
- ◆ Wide monitor current range from 10 μ A to 2.5 mA
- ◆ iC-WK with additional spike detection at monitor input MDA

APPLICATIONS

- ◆ Battery-powered LD modules
- ◆ LD Pointers
- ◆ Laser levels
- ◆ Bar-code readers

PACKAGES



SO8



MSOP8

BLOCK DIAGRAM

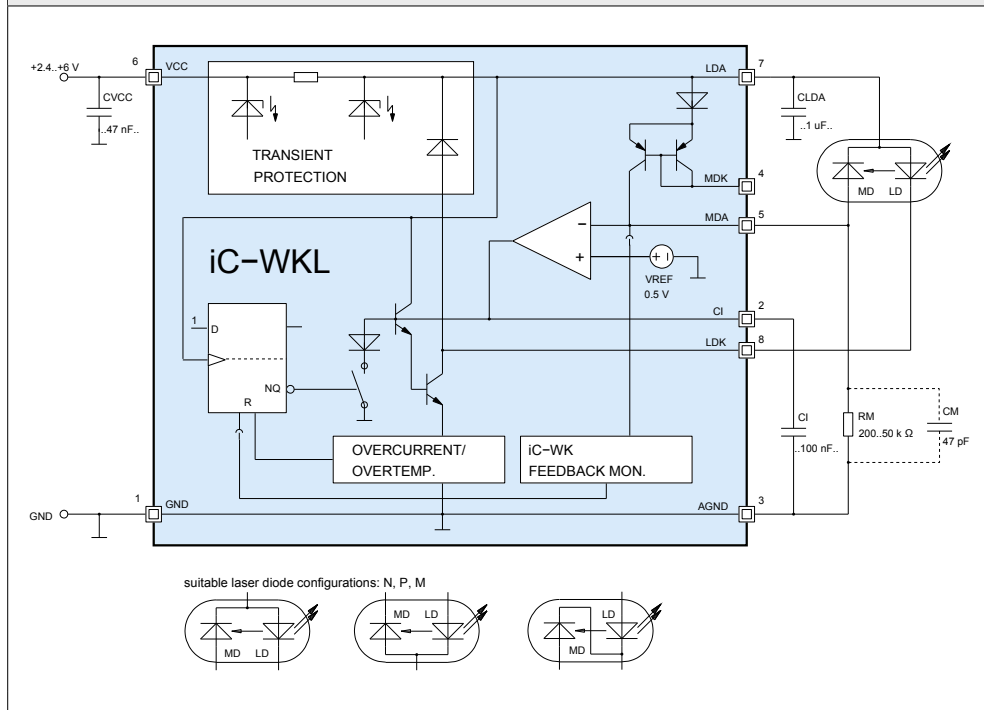

Copyright © 2020 iC-Haus

iC-WK, iC-WKL 2.4 V CW LASER DIODE DRIVER

Rev D2, Page 2/10

DESCRIPTION

The iC-WK/L device is a driver for laser diodes in continuous wave operation which requires only four external components. The wide power supply range of 2.4 to 6 V and the integrated reverse battery protection allow for battery operation with a minimum of two cells. A reversed battery connection destroys neither the iC nor the laser diode.

The iC includes integrated circuitry protecting against destruction by ESD, excessive temperature and overcurrent and a soft start which regulates the power and protects the laser diode when the power supply is switched on. The iC also filters the laser diode power supply for transients.

The power supply is regulated and adapted to the laser diode used by an external resistor at MDA. The monitor current acts as a reference and is regulated independent of the influence of temperature and supply voltage (range: 10 μ A to 2.5 mA). The capacitor at

CI determines the control time constants and start-up time.

A second monitor input, pin MDK, allows the driver to be used for other types of laser diode configuration; alternatively, it can be used as an analogue modulation input (DC to a few kHz).

In the event of failure, such as overcurrent in the laser path with a lack of feedback, for example, a quick power lockout is activated. The shutdown continues until power is reapplied, permitting a restart. The strain on power packs and batteries is relieved and the laser class is retained even in the event of a disturbance.

iC-WK offers additional protection by means of spike detection at pin MDA. Should spikes or oscillation occur at pin MDA the power lockout is activated.

PACKAGING INFORMATION SO8, MSOP8 to JEDEC

PIN CONFIGURATION SO8

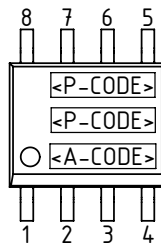

PIN CONFIGURATION MSOP8

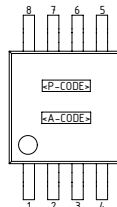

PIN FUNCTIONS

No.	Name	Function
1	GND	Ground
2	CI	Capacitance for Power Control
3	AGND	Reference Ground for CI, RM
4	MDK	Monitor Input 2 (MD Cathode, Modulation)
5	MDA	APC Setup, Monitor Input 1 (MD Anode)
6	VCC	+2.4 to +6 V Supply Voltage
7	LDA	Laser Supply (LD Anode)
8	LDK	Driver Output (LD Cathode)

Do not short-circuit pins AGND and GND, for this may deteriorate the precision of the regulator and interfere with the soft-start!

iC-WK, iC-WKL
2.4 V CW LASER DIODE DRIVER

Rev D2, Page 3/10

PACKAGE DIMENSIONS SO8

SIDE

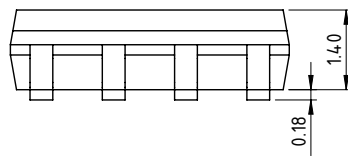

FRONT

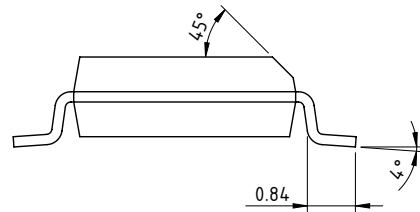

TOP

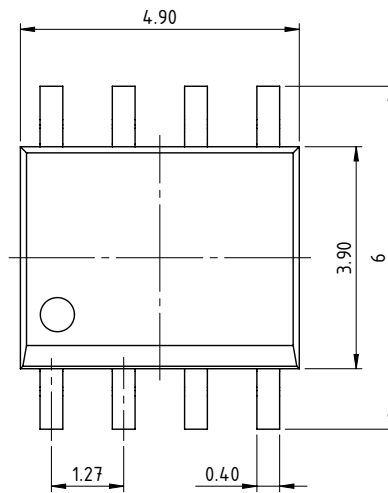

RECOMMENDED PCB-FOOTPRINT

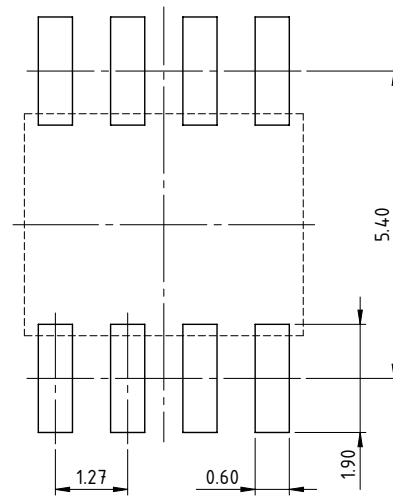

All dimensions given in mm. Tolerances of form and position according to JEDEC MS-012.

dra_so8-1_pack_1_10:1

iC-WK, iC-WKL
2.4 V CW LASER DIODE DRIVER

Rev D2, Page 4/10

PACKAGE DIMENSIONS MSOP8

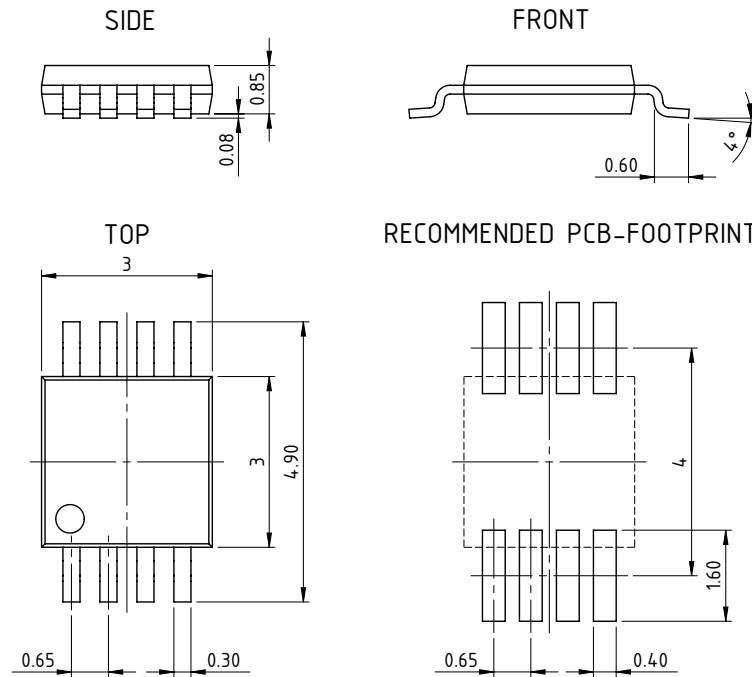

All dimensions given in mm. Tolerances of form and position according to JEDEC MO-187.

dra_msop8-2_pack_1_10:1

iC-WK, iC-WKL

2.4 V CW LASER DIODE DRIVER

Rev D2, Page 5/10

ABSOLUTE MAXIMUM RATINGS

No Destruction, correct function not guaranteed.

Item No.	Symbol	Parameter	Conditions			Unit
				Min.	Max.	
G001	VCC	Voltage at VCC		-6	6.5	V
G002	I(VCC)	Current in VCC		-10	95	mA
G003	I(CI)	Current in CI		-10	10	mA
G004	I(LDA)	Current in LDA		-95	10	mA
G005	I(LDK)	Current in LDK		-10	95	mA
G006	I(MDA)	Current in MDA		-10	10	mA
G007	I(MDK)	Current in MDK		-10	10	mA
G008	I(AGND)	Current in AGND		-10	10	mA
G009	I(GND)	Current in GND		-95	10	mA
G010	Vd()	ESD Susceptibility at all pins	HBM, 100 pF discharged over 1.5 kΩ		2	kV
G011	Tj	Operating Junction Temperature		-40	150	°C
G012	Ts	Storage Temperature Range		-40	150	°C

THERMAL DATA

Operating Conditions: VCC = 2.4...6 V

Item No.	Symbol	Parameter	Conditions				Unit
				Min.	Typ.	Max.	
T01	Ta	Operating Ambient Temperature Range		-40		85	°C
T02	Rthja	Thermal Resistance Chip/Ambient	SMD assembly, no additional cooling areas			140	K/W

All voltages are referenced to ground unless otherwise stated.
All currents flowing into the device pins are positive; all currents flowing out of the device pins are negative.

iC-WK, iC-WKL 2.4 V CW LASER DIODE DRIVER

Rev D2, Page 6/10

ELECTRICAL CHARACTERISTICS

Operating Conditions: VCC = 2.4...6 V, RM = 200 Ω...50 kΩ, Tj = -40...125 °C unless otherwise noted

Item No.	Symbol	Parameter	Conditions	Min.	Typ.	Max.	Unit
Total Device							
001	VCC	Permissible Supply Voltage		2.4		6	V
002	I(LDK)m	Permissible Laser Drive Current (closed control loop)	Tj = -40...125 °C Tj = -40...80 °C	5 5		70 90	mA mA
003	I _{dc} (VCC)	Supply Current without load path	closed control loop, I(MDK) = 0		2.4	5.5	mA
004	I _{off} (VCC)	Supply Current on Reset			2.4	5	mA
005	I _r (VCC)	Reverse Supply Current	RM = 50 kΩ, VCC = -6 V	-6	-3		mA
006	t _{on} ()	Turn-on Delay	VCC: 0 → 5 V to 95% I(LDK), I(LDK) = I(LDK)m; CI = 47 nF CI = 100 nF			70 150	μs μs
007	V _c (hi)	Clamp Voltage hi at VCC, LDA, MDK	I() = 10 mA, other pins open	6		9	V
008	V _c (LDK)hi	Clamp Voltage hi at LDK	V() < VCC + 1 V; I() = 10 mA, other pins open	6		9	V
009	V _c (MDA)hi	Clamp Voltage hi at MDA	I() = 10 mA, other pins open iC-WKL iC-WK	6 1.1		9 4	V V
010	V _c (hi)	Clamp Voltage hi at CI	I() = 10 mA, other pins open	1.1		4	V
011	V _c (lo)	Clamp Voltage lo at VCC, LDA, MDK, MDA, CI	I() = -10 mA, other pins open	-9			V
Reference and Monitor Inputs MDA, MDK, AGND							
101	V(MDA)	Reference Voltage at MDA	closed control loop, V(LDK) > Vs(LDK)	480	500	520	mV
102	dV(MDA)	Reference Voltage Temperature Drift at MDA	see 101;			120	μV/°C
103	I _{err} (MDA)	Input Current in MDA	closed control loop, I(MDK) = 0	-300		300	nA
104	dI(MDA)	Input Current Temperature Drift in MDA	see 103;	-2		2	nA/°C
105	APC _{err}	Control Error	RM = 10 kΩ, Tj = 0...80 °C RM = 10 kΩ, Tj = -40...125 °C			0.3 1	% %
106	dI(MD)	Supply Voltage Suppression of monitor current	V(VCC): 2.4 → 6 V, I(LDK) = 70 mA	-1		1	%
107	R _{gnd} ()	Resistor AGND-GND				3	Ω
108	V _f (MDK)	Voltage at MDK	V _f () = V(LDA) - V(MDK); I(MDK) = 1 μA...1 mA	0.46		2.1	V
109	CR()	Current Ratio I(MDA)/I(MDK)	I(MDK) = 10...500 μA I(MDK) = 500 μA...2.5 mA	0.975 0.95		1.025 1.05	
110	TC()	Current Ratio Temperature Coefficient I(MDA) / I(MDK)	I(MDK) = 10...500 μA I(MDK) = 500 μA...2.5 mA	-0.005 -0.025		0.005 0.025	%/°C %/°C
Laser Drive LDA, LDK							
201	V _s (LDK)	Saturation Voltage at LDK	I(LDK) = 40 mA I(LDK) = 70 mA, Tj = -40...125 °C I(LDK) = 90 mA, Tj = -40...80 °C			300 400 400	mV mV mV
202	dI(MD)	Load Balancing Error	I(LD) = 20 mA, I(LDK): 20 mA → 70 mA	-1		1	%
203	I _t (LDK)	Overcurrent Threshold in LDK	Tj = -40...125 °C Tj = -40...80 °C	70 90	130	300 300	mA mA
204	t _{off} ()	Overcurrent Reset Delay	lack of feedback: I(RM) = 0 to I(LDK) = I _t (LDK); I(LDK) = 20 mA, CI = 47 nF I(LDK) = 20 mA, CI = 100 nF I(LDK) = 60 mA, CI = 47 nF I(LDK) = 60 mA, CI = 100 nF			85 170 60 130	μs μs μs μs
205	V _f ()	Diode Forward Voltage LDK-LDA	I(LDK) < 70 mA			1.1	V
206	R _{vcc} ()	Transient Protection Resistor	VCC vs. LDA			4	Ω
207	V _t (MDA)	Shutdown Threshold at MDA	iC-WK only	0.56		2	V

iC-WK, iC-WKL

2.4 V CW LASER DIODE DRIVER

Rev D2, Page 7/10

ELECTRICAL CHARACTERISTICS

Operating Conditions: VCC = 2.4...6 V, RM = 200 Ω...50 kΩ, Tj = -40...125 °C unless otherwise noted

Item No.	Symbol	Parameter	Conditions	Min.	Typ.	Max.	Unit
Control Release Flip-Flop							
401	VCCen	Set Threshold for Enable Flip-Flop		0.6		1.9	V
402	Toff	Overtemperature Shutdown		125		150	°C

iC-WK, iC-WKL 2.4 V CW LASER DIODE DRIVER

Rev D2, Page 8/10

SAFETY INSTRUCTIONS

Laser light can damage the human eye and the eyes of animals! Do not look at any laser light directly or through any optical lens. When handling a laser diode, do not look directly at the light generated by it. Wear appropriate safety glasses to prevent light from entering the eye even by reflection.



TURN-ON/OFF BEHAVIOUR

Turn-on behaviour

After switching on the supply voltage the output stage remains disabled until the internal enabling flip-flop is set by a sufficiently high voltage at LDA.

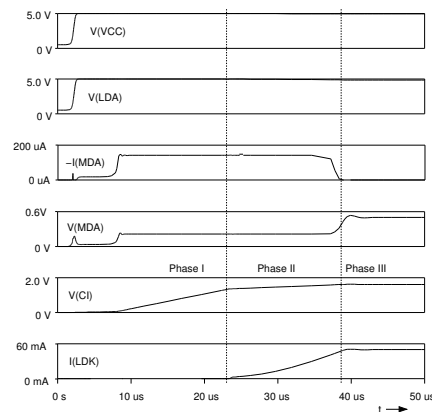

Figure 1: Turn-on behaviour

A quick soft start occurs during phase I; the control capacitor CI is loaded at an accelerated rate until the output stage supplies current at LDK. An open-circuit voltage at pin MDA is used to verify the external resistance.

Phase II, the initialisation process, begins when current starts to flow at LDK. This phase ends when the laser reaches its threshold current and the monitor current produced raises the potential at resistor RM.

The transition to CW operation (phase III) is gradual and primarily influenced by the CI and RM components. CI is properly dimensioned when the voltage overshoot at MDA is at a minimum.

Turn-off behaviour

iC-WK/L functions without a fixed undervoltage lockout, thus the laser diode forward voltage is the prime factor determining the lowest possible supply voltage.

If the voltage drops below this, the output stage is forcibly saturated and the laser current falls. In this instance iC-WK/L simultaneously discharges control capacitor CI so that no excessive laser diode currents occur when the supply voltage rises again.

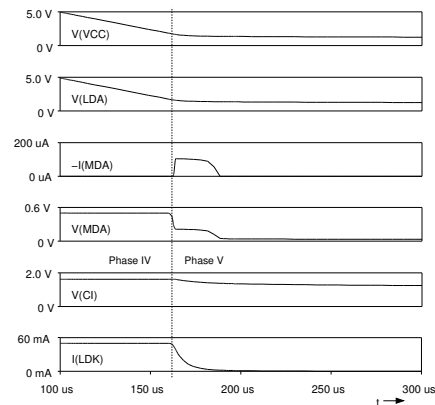

Figure 2: Turn-off behaviour

Disruptions in operation

The power control is shut down with excessive driver temperature or when the laser current reaches the over-current shutdown threshold, for example when the feedback is interrupted. If the monitor diode or the preset resistor RM fail, the device is shutdown in less than 250 μ s, provided that the supply voltage applied is high enough.

When modulating or switching the laser current via pin MDK (see Application Notes), excessive voltage occurring at pin MDA also causes a shut down (iC-WK only).

iC-WK, iC-WKL

2.4 V CW LASER DIODE DRIVER

Rev D2, Page 9/10

APPLICATION NOTES

Setting the output power

The output power is simply set by $RM = V(MDA) / I(MD)$; with $V(MDA) = \text{Item-No. 101}$ and $I(MD) = \text{monitor current at the desired operating point}$. RM should be combined from a fixed resistor (max. output power) and a potentiometer (calibration).

Further application notes on [iC-WK/L](#) and the data sheets of the evaluation modules and the demo board are available as separate documents.

REVISION HISTORY

Rel.	Rel. Date*	Chapter	Modification	Page
D2	2020-03-23	FEATURES	iC-WK MSOP8 AEC-Q100 qualified	1
		BLOCK DIAGRAM	Blue fill	1
		PACKAGING INFORMATION	Package dimensions added	3, 4
		ABSOLUTE MAXIMUM RATINGS	G010 updated	5

iC-Haus expressly reserves the right to change its products and/or specifications. A Datasheet Update Notification (DUN) gives details as to any amendments and additions made to the relevant current specifications on our internet website www.ichaus.com/DUN and is automatically generated and shall be sent to registered users by email.

Copying – even as an excerpt – is only permitted with iC-Haus' approval in writing and precise reference to source.

The data specified is intended solely for the purpose of product description and shall represent the usual quality of the product. In case the specifications contain obvious mistakes e.g. in writing or calculation, iC-Haus reserves the right to correct the specification and no liability arises insofar that the specification was from a third party view obviously not reliable. There shall be no claims based on defects as to quality in cases of insignificant deviations from the specifications or in case of only minor impairment of usability.

No representations or warranties, either expressed or implied, of merchantability, fitness for a particular purpose or of any other nature are made hereunder with respect to information/specification or the products to which information refers and no guarantee with respect to compliance to the intended use is given. In particular, this also applies to the stated possible applications or areas of applications of the product.

iC-Haus products are not designed for and must not be used in connection with any applications where the failure of such products would reasonably be expected to result in significant personal injury or death (*Safety-Critical Applications*) without iC-Haus' specific written consent. Safety-Critical Applications include, without limitation, life support devices and systems. iC-Haus products are not designed nor intended for use in military or aerospace applications or environments or in automotive applications unless specifically designated for such use by iC-Haus.

iC-Haus conveys no patent, copyright, mask work right or other trade mark right to this product. iC-Haus assumes no liability for any patent and/or other trade mark rights of a third party resulting from processing or handling of the product and/or any other use of the product.

Software and its documentation is provided by iC-Haus GmbH or contributors "AS IS" and is subject to the ZVEI General Conditions for the Supply of Products and Services with iC-Haus amendments and the ZVEI Software clause with iC-Haus amendments (www.ichaus.com/EULA).

* Release Date format: YYYY-MM-DD

iC-WK, iC-WKL

2.4 V CW LASER DIODE DRIVER

Rev D2, Page 10/10

ORDERING INFORMATION

Type	Package	Order Designation
iC-WK	SO8	iC-WK SO8
iC-WK	MSOP8	iC-WK MSOP8
iC-WKL	SO8	iC-WKL SO8
iC-WKL	MSOP8	iC-WKL MSOP8
WK Module for P-/M-Type Laser		iC-WK iCSY WK1D
WKL Module for P-/M-Type Laser		iC-WKL iCSY WK1D
WK Module for N-Type Laser		iC-WK iCSY WK2D
WKL Module for N-Type Laser		iC-WKL iCSY WK2D
WK Evaluation Board		iC-WK EVAL WK4D
WKL Evaluation Board		iC-WKL EVAL WK4D

Please send your purchase orders to our order handling team.

For technical support, information about prices and terms of delivery please contact us.