

# LASER OPTICS





small components  
**MASSIVE IMPACT**



# CONTENT

Editorial.....	007	Dielectric Coatings.....	040
Customized Products.....	008	Highly Reflective Optics.....	042
Coating Methods.....	010	Laser Mirror Coatings.....	042
E-Beam Coating.....	010	Long-Pass/Short-Pass Coatings.....	044
IAD Coating.....	012	Partially Reflective Optics.....	046
IBS Coating.....	014	Output Couplers.....	046
Technology.....	016	Standard Beam Splitters.....	048
Coating Designs.....	020	Polarization-Independent Beam Splitters.....	050
Quality Control.....	024	Thin-Film Polarizers.....	052
Measurement Technology.....	024	Standard Thin-Film Polarizers.....	052
Laser-Induced Damage Threshold (LIDT).....	028	45° Thin-Film Polarizers.....	054
Substrates.....	034	Broadband Thin-Film Polarizers.....	056
Development.....	036	Optics for Special Applications.....	058
Standards Committee.....	038	Gaussian Mirrors.....	058
		AR-Coatings.....	060
		V-AR and U-AR Coatings.....	060
		BBAR/DAR Coatings.....	062
		Substrates.....	064
		Glass Materials.....	066
		Plane Substrates.....	068
		Spherical Substrates.....	072
		Cylindrical Lenses.....	076
		Prisms.....	078
		Product Codes.....	082
		Index.....	084
		Imprint.....	087



# Laser Optics Tradition

Dear Reader,

Thank you for your interest in LASER COMPONENTS' products and services. In this catalog, we will provide you with a current overview of our wide range of laser optics.

LASER COMPONENTS GmbH was originally founded as a sales company. Just four years later - in 1986 - the first production facility was opened for the coating of laser optics. Based on this experience, we have always been able to follow our guiding principle: delivery of the highest quality. The positive feedback from our customers and long-term sales success confirm this.

In the spring of 2008, we expanded our production. Since then, we have manufactured lens substrates in Olching to guarantee short delivery times and consistently high quality. Since 2015, we have expanded our laser optics production – this time in the area of coatings. We are now in a position to coat laser mirrors with a diameter of up to 390 mm for our customers – of course, completely homogeneously across the entire surface area. Further investments will follow.

Currently, we sell more than 35,000 components in laser technology and optoelectronics. Approximately half of these products are now produced in house. Furthermore, we provide an additional forty manufacturers with competent access to international markets.

In addition to our headquarters at LASER COMPONENTS in Olching (near Munich), global operation now includes production facilities in three countries and sales offices in four countries. Furthermore we work closely with more than 20 distributors in Asia, Europe and America. Internationally, over 230 employees are currently advancing the success of the company. Customer inquiries encounter specialized experts and are always answered reliably; this includes very specific issues. Over 5,000 customers value this service and place their trust in us.

Stability and continuity coupled with dynamics, flexibility, and flat hierarchies are the fundamental values of our family-run business. Targeted investments in development are our response to market signals and customer needs. This ensures the future availability of new high-quality products and services and thus the further success of the company.

Yours



Patrick Paul  
CEO



Patrick Paul

# Customized Products



Headquarters & Production Site, Olching/Munich

## How to Use this Catalog

This catalog shall give an idea to our customers about our capabilities on laser optic production. We produce most components to custom specifications and delivery schedules, this is not a catalog of standard parts.

### **One of Our Strengths: Custom Products**

One of LASER COMPONENTS' strengths is the production of custom optics, even in small quantities. Simply provide us with your desired specifications such as material, size, shape, and coating and our product engineers will assess production feasibility.

### **Further Information**

For many coatings in this catalog, reflection and transmission simulation curves are provided. Feel free to enquire about any of the curves not printed here.

All values in the tables and specifications follow the U.S. format. Values of 1000 are separated by a comma instead of a period, and a decimal point is used as the decimal mark instead of a comma.



## Contacts

### Germany / Worldwide

LASER COMPONENTS GmbH

Werner-von-Siemens-Str. 15  
82140 Olching / Germany

Tel.: +49 8142 2864-0  
info@lasercomponents.com  
[www.lasercomponents.com](http://www.lasercomponents.com)

### France

LASER COMPONENTS S.A.S.

45 Bis Route des Gardes  
92190 Meudon / France

Tel.: +33 1 3959 5225  
info@lasercomponents.fr  
[www.lasercomponents.fr](http://www.lasercomponents.fr)

### Nordic Countries

LASER COMPONENTS Nordic AB

Skårs led 3  
41263 Göteborg / Sweden

Tel.: +46 31 703 71 73  
info@lasercomponents.se  
[www.lasercomponents.se](http://www.lasercomponents.se)

### USA

LASER COMPONENTS USA, Inc.

116 South River Road  
Bedford, NH 03110 / USA

Tel: +1 603 821 7040  
info@laser-components.com  
[www.laser-components.com](http://www.laser-components.com)

### Great Britain

LASER COMPONENTS (UK) Ltd.

Goldlay House 114 Parkway  
Chelmsford Essex CM2 7PR / UK

Tel: +44 1245 491 499  
info@lasercomponents.co.uk  
[www.lasercomponents.co.uk](http://www.lasercomponents.co.uk)

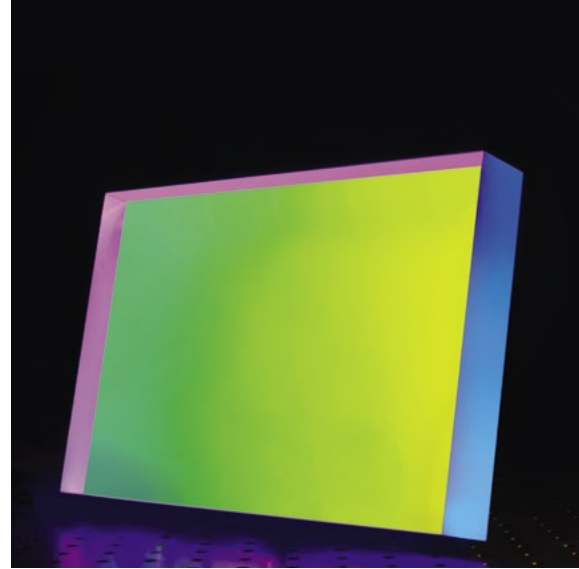

# Coating Methods



## E-Beam Coating

The e-beam process is the most widespread coating technique in laser technology and has been used at LASER COMPONENTS in its almost original form since 1986. In this method, dielectric coating materials are reactively evaporated in a high vacuum with an electron beam (e-beam), by injecting oxygen into the coating chamber. However, to deposit stable layers, the substrates must also be heated to approx. 250 °C.

Our empirical evaluation has shown that evaporation geometry can be used in an e-beam chamber in such a way that different layer thicknesses can be deposited on different substrates in a single batch. This makes it possible, for example, to manufacture mirrors with different degrees of output coupling or different angles of incidence in the same operational step.

This significantly reduces the cost of labor and materials. Naturally, these savings are automatically passed on to our customers.

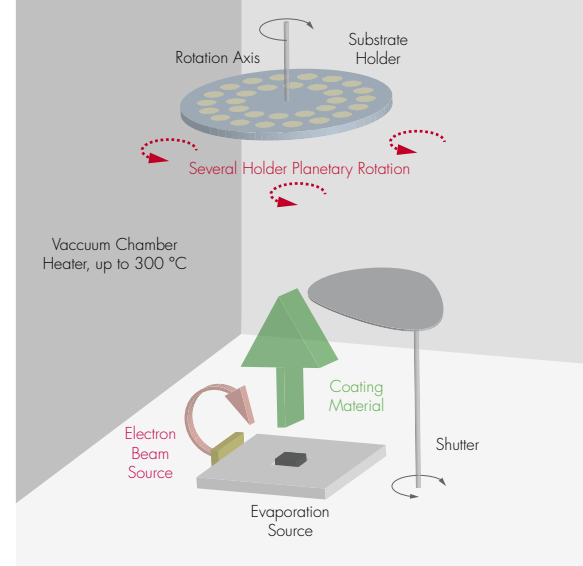

Electron Beam Coating Chamber

### Chamber Specifications

- **Maximum substrate diameter:** 200 mm
- **Typical batch size:** 100 substrates at  $\varnothing = 1.0''$
- **Short coating times at temperatures above 250 °C**
- **Maximum flexibility:** Simultaneous production of optics for different angles of incidence

### Features

In this method, the deposition of different materials makes it possible to manufacture so-called cw/fs coatings in addition to high-power coatings. The coating affects the bandwidth, dispersion behavior, scattering losses, and damage threshold of the optics.

# Coating Methods



## IAD Coating

Similar to e-beam coatings, ion-assisted deposition (IAD) coatings also rely on the reactive evaporation of dielectric coating materials in a high vacuum with an electron beam. To achieve more stable layers, however, the substrate needs lower pre-heating. Instead, precious gas ions that are not integrated into the layer structure are fired at the condensing layers. These ions provide the layers with the same kinetic energy achieved by heating the substrate in the e-beam method. Due to this dense coating structure, it does not lead to spectral drift because water does not become deposited during ventilation of the unit. In addition, the layer structures and surfaces feature particularly low scattering.

The advantages of IAD coatings, however, come with one crucial disadvantage: Because the layers are more compact and do not exhibit any sorption behavior, they are subject to high stress and bend each substrate. Therefore, it is more difficult to maintain the surface figure required by the customer after completing of the coating.

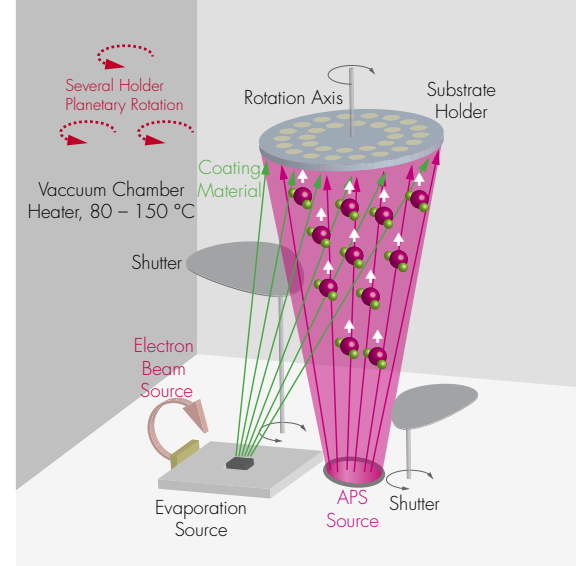

Ion Assisted Deposition Coating Chamber

In the IAD method, the substrate surfaces are heated slightly to produce a uniform temperature at the surface. Due to melting of the coating material, which can reach up to 2000 °C substrates can themselves heat up to 150 °C depending on the coating design and material deposited. The ion sources operated at several kilowatts also produce radiation heat. Thus, substrates continue to heat up the longer they are in the coating chamber. To prevent this, the entire chamber is continuously controlled at an acceptable temperature level.

#### Chamber Specifications

- **Maximum substrate diameter:** 390 mm
- **Typical batch size:** 80 substrates at  $\varnothing = 2.0''$
- **Surface homogeneity:** <1% within  $\varnothing = 380$  mm

#### Features

This chamber is specifically optimized for homogenous coating on large optics and for large quantities in production.

# Coating Methods



## IBS Coating

Unlike e-beam and IAD coatings, the coating material in the ion beam sputtering (IBS) method is not evaporated by an electron beam but rather knocked out of a target by an ion beam and atomized (sputtered). Therefore, the material particles have particularly high kinetic energy and are very flexible when they deposit on the substrate. Thus, voids can be easily filled. This results in layers with very low scattering and particularly smooth surfaces. The layers are subject to even higher stress than in the IAD method.

Compared to electron beam evaporation, the sputtering method has two crucial advantages: firstly, such process parameters as energy input, layer growth rate, and oxidation level can be adjusted precisely and independently. Secondly, designs with several hundred layers can be completed in a single coating run because the amount of material is not restricted by the size and number of crucibles.



### Chamber Specifications

- Batch capacity depends on the desired homogeneity of the coated optics (usually lower than in e-beam or IAD methods)

### Features

- Lowest scattering losses and very high reflection values ( $R > 99.99\%$ )
- No water retention and thus no temperature drift
- Smooth surfaces with low roughness
- "Cold" coating method and thus suited for temperature and moisture-sensitive substrates, i.e. no heating
- Stable and reproducible process for complex layer designs

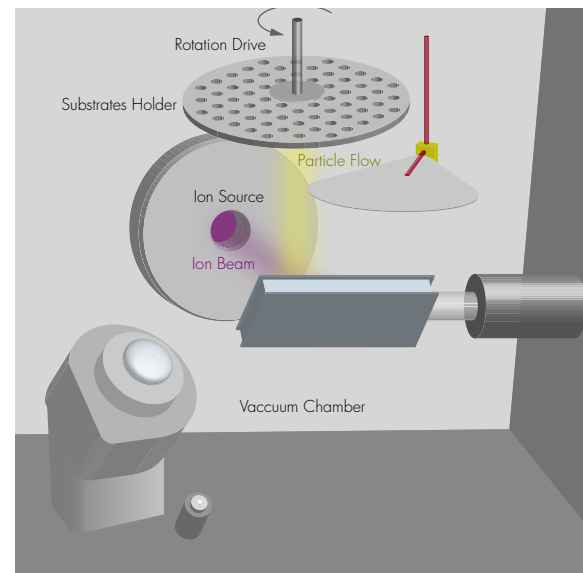

Ion Beam Sputtering Coating Chamber

# Technology

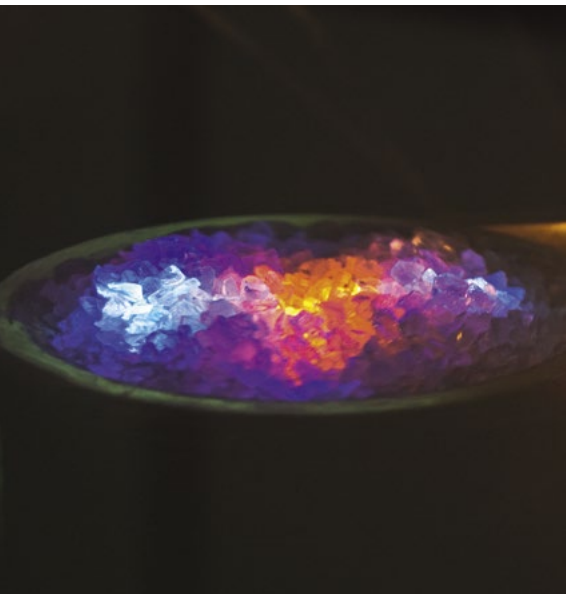

## Layer Thickness and Materials

Laser optic coatings consist of a series of single layers that have a layer thickness in the range of 10–100 nm. The layers must be absorption free from the UV to the near infrared range and have a suitable refractive index.

Each layer design consists of two materials: one with a low refractive index and one with a higher refractive index. The same coating materials have been used for decades, irrespective of the technology applied. The material with the low refractive index used for all optics is  $\text{SiO}_2$ . The high refractive material must be selected depending on the application and wavelength needed.



Mirrors with high reflection values require a larger number of layers. That does not necessarily mean an increase in coating complexity. The complexity and design depends on the layer thickness, which, in turn, is based on the laser wavelength. For a wavelength of 248 nm,  $\text{HfO}_2$  and  $\text{SiO}_2$  are applied at a layer thickness of 31 nm and 41 nm. At 2940 nm, the single layers ( $\text{Ta}_2\text{O}_5/\text{SiO}_2$ ) have a thickness of 360 nm and 400 nm.

The complexity, and thus the cost, does not depend on the coating design but on the laser wavelength for which the mirror is produced.

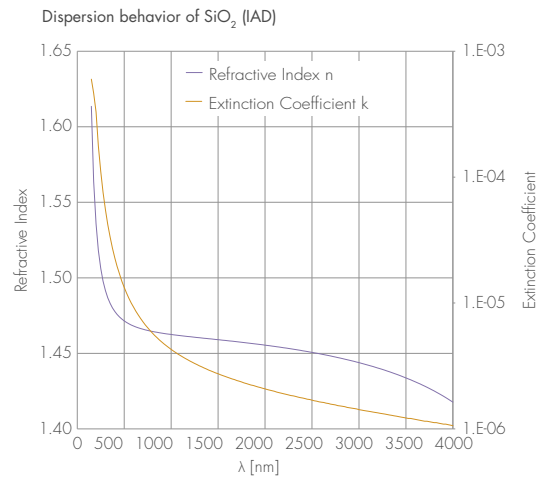

# Technology

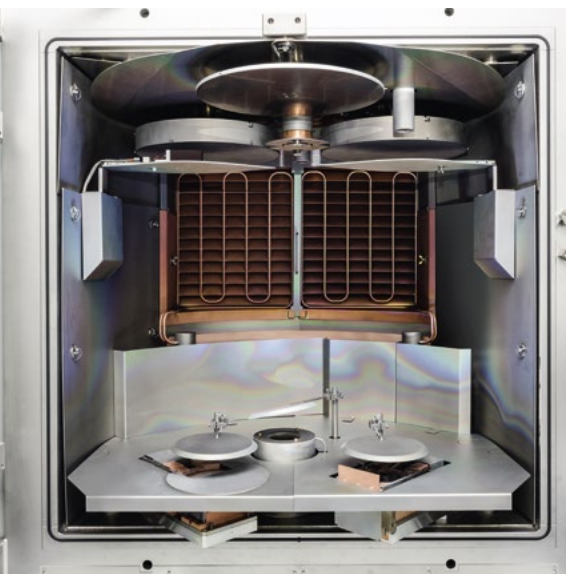

## Online Broadband Monitoring

In general, there are three ways to determine the layer thickness during the production process: monitoring a measuring window (called a monitor or witness piece), monitoring the behavior of a quartz crystal, or simply using a timer. These conventional methods are insufficient to meet the growing demands placed on laser optics today. Leading manufacturers such as LASER COMPONENTS now rely on real broadband monitoring (BBM).

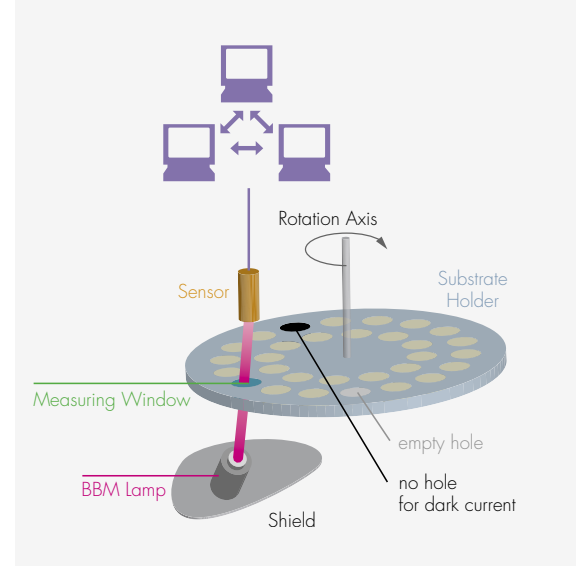

Schematic diagram: Broadband Monitoring

In broadband monitoring, a diode spectrometer is used to monitor the visible spectrum during the coating process. An empty hole on the substrate holder allows unfiltered light to enter while an area without a hole produces a dark current. The incoming signal, which enters via a measuring window, is compared to these reference values. This allows the current layer thickness to be determined with an absolute accuracy of  $\pm 0.5$  nm. With the help of these comparative measurements, the system continuously calibrates itself. Via these measurement results in the spectrum from 400 nm to 1000 nm, the values for the UV range of  $< 400$  nm and the NIR range of  $> 1000$  nm can be calculated. This requires exact knowledge of the dependency of the wavelength's refractive indices for the materials used in the spectral range from 190 nm to 3200 nm. This comes from the simulation of the design, which is available for all coating designs at LASER COMPONENTS.

Broadband monitoring is used at LASER COMPONENTS in IAD and IBS coatings. It is used, for example, when manufacturing thin-film polarizers, the precision requirements in layer thickness of which are particularly high.

# Coating Designs



## Optimum Design for Each Application

### Single Wavelength

The simplest laser optics are manufactured for a specific wavelength and a specific angle of incidence. These optics are characterized by very high functionality and very high damage thresholds in the specified range.

#### Key Issues

These designs are easy to produce, however, the specifications are always only valid for the desired wavelengths and angles of incidence. Special designs and manufacturing equipment make custom solutions possible, often affecting other parameters. For example, a higher reflection can have an effect on the damage threshold. In such cases, we develop an appropriate solution together with our customer.

### Multiple Wavelengths

It is often necessary to combine wavelengths, separate wavelengths, or direct several wavelengths across the same optical path. Dichroic mirrors, filters, and multiple-wavelength mirrors are used for this purpose. With the technologies available today, it is also possible to produce optics that can be used for several clearly-defined wavelengths; however, this is sometimes at the cost of the damage threshold or other specifications.

#### Key Issues

In multiple-wavelength mirrors, the reflection is typically somewhat lower and the angle of incidence is more sensitive. Some designs require additional thicker layers, which can affect both the surface figure after coating and the damage threshold. They can also be used in applications in which only one of the wavelengths is used. This makes them more flexible during application.

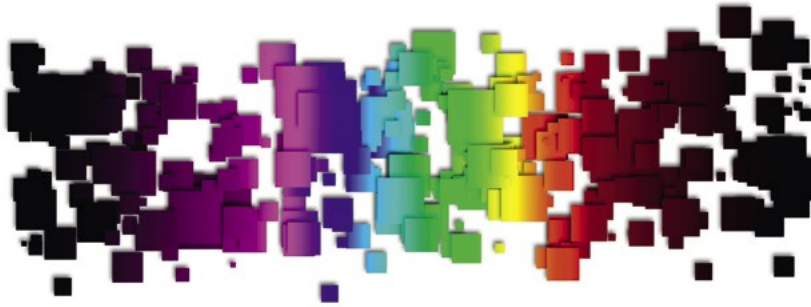

### Broadband Wavelength

State-of-the-art fs lasers with extremely short pulses often require broadband coatings with high reflection values across a broad spectrum, good dispersion properties, and a high damage threshold. We work with our customers here as well to create an optimum design for each application.

These coatings feature:

- Large bandwidth
- Low-scatter surface
- Low dispersion properties

### Key Issues

In addition to the large wavelength bandwidth, it is important in fs lasers to also note the dispersion properties and phase shifts. Depending on the group delay dispersion (GDD), an extremely short laser pulse on a dielectric mirror is broadened via the coating. The single-stack fs coating from LASER COMPONENTS has a very low GDD value and is, therefore, optimally suited for these applications.

# Coating Designs

## Advantages and Disadvantages of Coating Methods

Features	Typ	E-Beam	IAD	IBS
Max. size [ømm]		200	380	130–140
Process temperature [°C]		250	80–150	40–100
Wavelength range [nm]		193–2000	248–3000	248–3000
Stress to substrate		Low	Medium	High
Designs	Mirror	Standard mirrors	Large quantities, large optics, broad band coating	R > 99.99%
	TFP	–	Mainly for large quantities or large optics	Different optimization for R or T possible
	Dichroic	Standard designs	Large quantities, optimized transmission	Optimized transmission
	Beamsplitter	Standard designs, set of beamsplitters	Better accuracy, combination with other wavelength	Polarization independent beamsplitter
	Output coupler	Standard designs, set of beamsplitters	Better accuracy, combination with another wavelength	Better accuracy, combination with another wavelength
	Gaussian mirror	Designs up to R = 70 %	–	–
Coating properties	High reflection	+	++	+++
	Low Scattering	+	++	+++
	Low absorption	+	+	++
	LIDT	++	++	++
	Stress	++	+	o

Table 1: Coating methods in relation to various parameters of process, design, coating

The optimization of one parameter often affects the parameters of other specifications, as well as the capabilities and tolerances in production and measurement technology. The high art is the ability to find an optimum solution together with the customer with regard to application, production, and feasibility (see Tables 1 and 2).

	R	LIDT	T	GDD	Bandwidth	Flatness after Coating	Low thermal drift	Price
$R_{max}$	■	■	■	■	■	■	■	\$\$\$
$T_{max}$ for Dichroic	■	■	■	■	■	■	■	\$\$
GDD	■	■	■	■	■	■	■	\$
Bandwidth	■	■	■	■	■	■	■	\$\$\$
Flatness	■	■	■	■	■	■	■	\$\$\$
$LIDT_{max}$	■	■	■	■	■	■	■	\$\$

■ optimized   ■ reduced specifications   ■ strong influences   ■ no influences

Table 2: Schematic of the correlation between various laser optics parameters

# Quality Control

## Interpretation of Simulation Curves

The reflection and transmission behavior of many coatings is shown in this catalog in spectral curves. The calculated values are purely theoretical.

We only guarantee the values specified and confirmed in the specifications in an order.

## Measurement Technology

Our customers have clear requirements for the spectral values of their laser optics. With a spectrophotometer, the reflection and transmission are always measured with respect to the wavelength, angle of incidence (AOI), and polarization.

### Measured and Calculated Spectral Curves

With each batch, a spectral curve that represents the reflection and transmission behavior of the laser optics that have been ordered can be supplied. Two reference optics are coated in the same production process and their behavior measured in the desired spectrum. If the results correspond to the required specifications, then the run is considered OK and may be sent out. Each batch and the corresponding reference optics are assigned a unique identification number. Similar to accounting documents, the reference optics are kept for at least 10 years.

Information on the spectral requirements is specified in DIN 58197.

LASER COMPONENTS, however, also accepts other styles of notation as long as the requirement is clear. For example, it is common in the industry to describe the reflection and transmission not as absolute values ( $\rho$  and  $\tau$ ) but rather as percent values (R and T). That is,  $\rho < 0.01$  corresponds to  $R < 1\%$ .

At LASER COMPONENTS we also follow this nomenclature.



Comparison measured/simulated curve for beamsplitter coating

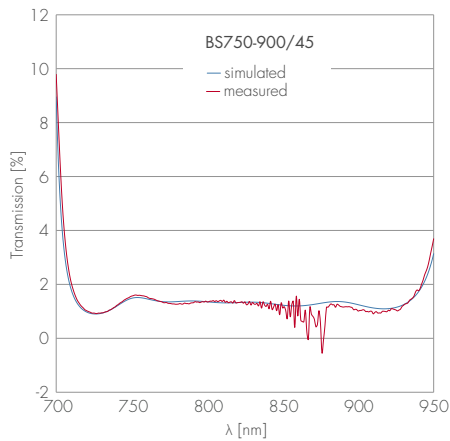

Comparison measured/simulated curve for anti-reflective coating

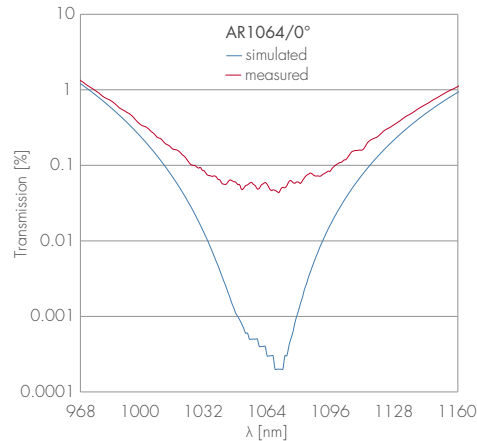

## Verification of Measurement Errors

Laser mirrors for a special wavelength can be used to detect and correct measurement errors in the spectrophotometer by comparing them with a standardized reference mirror. The reflection values of these comparative mirrors are certified by an independent measurement laboratory or by the manufacturer.

The crucial parameter for the quality of laser optics is generally reflection. With standard measurement technology, this value can only be measured at a deviation of approx.  $\pm 0.5\%$  for high reflection (HR), and  $\pm 0.01\%$  for anti-reflection (AR). If, however, the transmission is measured, the deviation is only  $\pm 0.05\%$ . Therefore, it is common for most wavelengths to measure the transmission and calculate the reflection value from the transmission ( $R = 100\% - T$ ). We assume that with our coating technologies the losses from absorption and scattering are negligible.

### Transmission Measurements

Transmission is measured with an AOI of  $0^\circ$  to  $75^\circ$  in the following spectra:

- **Unpolarized light:** 190nm to  $3.2\mu\text{m}$
- **Polarized light:** 250nm to  $3.2\mu\text{m}$

### Reflection Measurements

Reflection can be measured starting at an AOI of  $8^\circ$ . The difference between the spectra at  $0^\circ$  and  $8^\circ$ , however, is negligible in reality. At angles between  $8^\circ$  and  $75^\circ$ , the spectra can be determined for polarized light. We also make measurements in the following spectra:

- **Unpolarized light:** 190nm to  $3.2\mu\text{m}$
- **Polarized light:** 250nm to  $2.2\mu\text{m}$

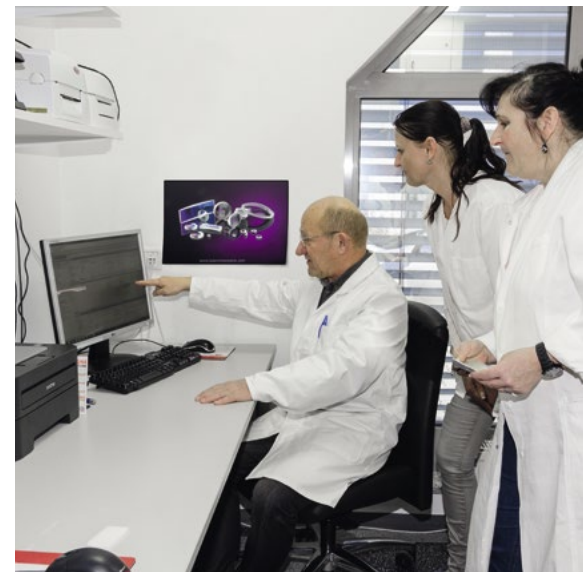

# Quality Control

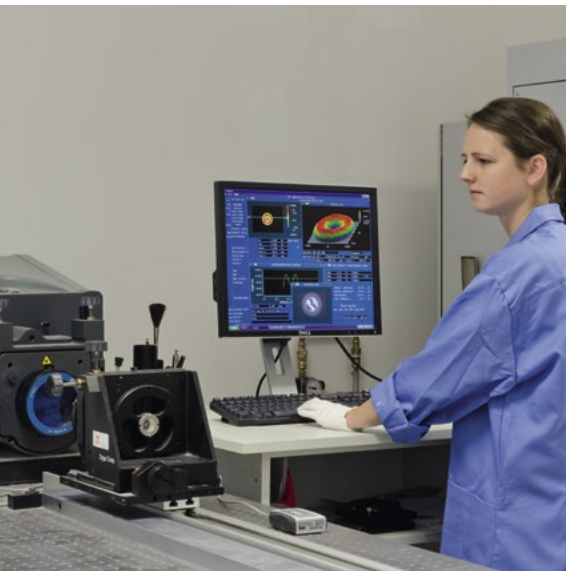

## **Interferometer**

In laser optics, there is a difference between flat surfaces and lenses with a clearly specified radius of curvature. The corresponding surfaces and tolerances can be found in the international standard DIN ISO 10110-5.

The surfaces of the optics are measured interferometrically.

Definitions and specifications of the shape of the surfaces vary greatly. It is, therefore, very important to us to clarify with the customer ahead of time how the surface tolerances of the optics will be specified and measured. The wavefront deformation caused by the layers and the substrate is, in most cases, crucial for quality control.



### **Autocollimator**

An important quality parameter for lenses is the centering of the radii of the substrate. The definitions and tolerances are specified in the international standard DIN ISO 10110-6. For measurement purposes, LASER COMPONENTS uses an autocollimator.

### **White-Light Interferometer**

The surface quality is determined by the polish in substrate production and is regulated by DIN ISO 10110-8.

The coating on the optics are between 100 nm and 10  $\mu\text{m}$  thick. Through the coating process, they are not completely smooth; however, the surface roughness is only a few nanometers. Therefore, scratches, roughness, and irregularity remain unchanged on the surface of the manufactured product after coating.

At LASER COMPONENTS, the surface quality is measured with a white-light interferometer. From the quadratic mean of all measurement results, the root mean squared (RMS) Ra and other value can be calculated.



# Quality Control



## Laser-Induced Damage Threshold (LIDT)

Optics used in both laser resonators and beam guidance have to withstand laser radiation in long-term operation. How successful the optics are is described by the laser-induced damage threshold (LIDT) found in the international standard DIN ISO 21254-1-3.

To determine the damage threshold, the optics are exposed to a laser until the surface becomes damaged. The calculated fluence or energy density of the damage threshold is measured in  $\text{J}/\text{cm}^2$ .

In general, a large number of single test shots is carried out; therefore, there is always a statistical component to determining the damage threshold. The graphical representation contains the damage probability of all given fluence values.

A straight line leads from the occurrence of the first damage to the fluence value in which damage always occurs. It is standard in the industry and at LASER COMPONENTS to specify the statistical average as the damage threshold (i.e., the fluence with a damage probability of 50%).

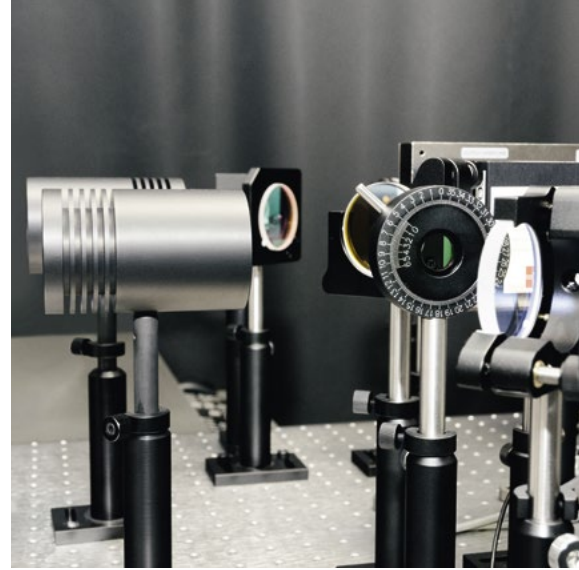

At our own LIDT measuring station, we can measure the damage threshold for the wavelengths 1064 nm and 532 nm, using 7ns laser pulses at 10 Hz. We use for our internal measurement in-house the S-on-1 method. Measurements with other specifications are carried out by international testing laboratories or directly by the customer.

The damage threshold of an optic strongly depends on the substrate surface quality, coating design and technology. Both are, therefore, always discussed in detail with the customer. Based on these specifications, the development and production teams at LASER COMPONENTS are constantly working on the optimization of optics.

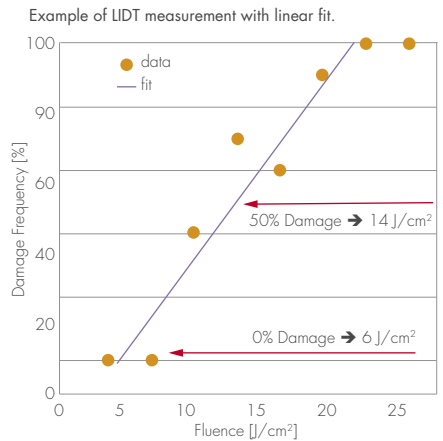

# Quality Control



## Testing Surface Imperfections

Cleanliness of the surface is a crucial criterion for the quality of laser optics.

All types of surface imperfections and their corresponding tolerances are defined in DIN ISO 10110-7 and the U.S. standard MIL-PRF-13830-B.

Testing for defects, scratches, and impurities has been carried out visually by experienced personnel in the shipping department at LASER COMPONENTS. Imperfections with a diameter of 10  $\mu\text{m}$  can be recognized in transmission or reflected scattered light. Reference plates according to ISO 10110-7 are used to describe the surface imperfections.

Optical testing devices according to DIN ISO 14997 are used to guarantee objective results. This allows the size of the surface imperfections to be measured precisely and in relation to the entire surface (mapping).



### Testing Reflection Values, Absorption, Scattering, and GDD

In addition to the spectral values of reflection and transmission, other values are often requested that require special measuring stations: for example, the measurement of very high reflection values ( $>99.99\%$ ) or the group delay dispersion (GDD) of state-of-the-art laser optics. Often, the actual absorption and scattering losses have to be determined as well.

In these cases, LASER COMPONENTS engages internationally-operating testing laboratories or collaborators with other manufacturers in the market that have such measuring stations at their disposal.



# Quality Control



## **Layer Adhesion and Environmental Resistance**

The quality of the optics depends not only on the optical characteristics but also on other crucial values such as adhesive strength, hardness, abrasion resistance, and most importantly, environmental resistance. For all optics manufactured by LASER COMPONENTS, specifications according to DIN ISO 9022 and 9211, as well as the U.S. military standard MIL-C-14875-C, can be defined. Moreover, we can also carry out additional measurements per customer request in a certified climatic chamber. The subsequent visual inspection of the tested optics ultimately determines whether all requirements are fulfilled.





## Packaging

For standard dimensions, all optics are packaged in boxes without any tissues. This allows the customer to use the optics without any cleaning if, for example, they are opened in a clean environment.

If required single packaging is possible.

## Cleaning

The cleanliness of a substrate is very important, particularly when handling high power levels. Otherwise, the laser beam could destroy the coating and with it the optic. In case cleaning is requested, an acetone or isopropanol resistant cloth can be used.

For more information on cleaning, please feel free to contact us.

### Good to know:

It is also possible to apply, via laser marking, the batch number and, upon request, customer designations to the edge of most optics.

# Substrates



## Substrates for Laser Optics

At LASER COMPONENTS you may choose from a variety of laser optic substrates. The numerous coating options result in a wide range of optical components for all applications. To achieve best results, the substrate and coating have to be optimally matched to one another, especially with respect to the optical and mechanical properties of the substrate.

### Measurement Technology and Quality Control

All of the measurement equipment described in the section on coatings is available for substrates as well. Depending on the customer's needs, the flatness, surface figure, wedge, and dimensions are 100% verified or in accordance with ISO standards. The substrates are cleaned in an ultrasonic washing system prior to coating; they are visually checked for cleanliness both before and after coating.

### Traceability

Each batch receives a unique identification number that contains all the important information on the product and its manufacturing processes, thus all items can be traced at any time.

## Substrate Production

At LASER COMPONENTS we are committed to production at our headquarters in Germany. Driven by our R&D department, we have added our own substrate manufacturing to complement our existing coating production, that was established many years ago. We are therefore able to offer the entire chain of production in house and are able to ensure that our high standards of quality are met during each process. We are also able to implement customer requests at any time, even at short notice.



# Development

We are often asked about the most unique aspect of LASER COMPONENTS. This would have to be the professional network of optical, fiber-optic, and opto-electronic technologies that serves as the knowledge base at all of our production sites. In addition, we have a cross-disciplinary R&D department that is active in our core technological areas. The combination of different competencies makes us quite special and gives us the ability to take on complex development projects for our customers. The typical course of a development project is shown in the schematic.

01

## IDEA

We all have a creative side, but sometimes formulating an idea can be a challenge: We support our customers by coming up with solution-oriented approaches.



02

## NDA

Ideas have to be protected: Together we set up the regulatory framework with an NDA. We either process your proposal or create our own draft.



03

## SPECIFICATION

The results expected in development have to be defined and confirmed: We will provide assistance with the development of a specification sheet.

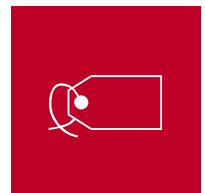

04

## IMPLEMENTATION

Let the fun begin! We work project-oriented, with milestones and timelines, and keep you updated on interim results.

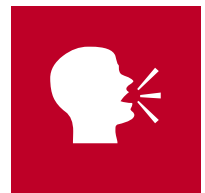



05

## VERIFICATION

Results are recorded in detail with test certificates and bring milestones to a close.



06

## SAMPLE APPROVAL

Sample approval is the responsibility of the customer in a specific application that has already been determined.



07

## SERIES PRODUCTION

The start of production is a challenge. The defined process is central to production: In close collaboration with specialists, the component is transferred to production.



08

## PRODUCT CARE

We are always open to your thoughts and experiences; further developments are often based on the feedback of our customers.



# Standards Committee

## Standards Guarantee Quality

### Shaping the Future

Quality and precision are not only challenging success factors in an industry that measures in  $\mu\text{m}$  and  $\text{nm}$ , but they are also basic requirements. The smallest impurities can have serious effects. Particularly in the laser industry, internationally recognized standards are of great importance. They provide a binding framework, as well as consistent and comparable quality along the entire chain of production. Through careful documentation, the manufacturer and customers both obtain a high level of legal certainty.



Dr. Lars Mechold, CTO

In a technological branch that sees new developments on an almost daily basis, the quality standards change with the technical possibilities. Therefore, it is important for LASER COMPONENTS not only to maintain standards and norms, but also to actively contribute to their development. For example, our experts participate in the standards committee on laser damage thresholds for optics. In this critical area, you can be sure as a customer that we at LASER COMPONENTS always know which demands the market places on our work and our products, or will in the near future.

# DIELECTRIC COATINGS

Send us an email or give us a call!

[info@lasercomponents.com](mailto:info@lasercomponents.com)

- Germany: +49 8142 28640
- USA: +1 603 821 7040
- France: +33 1 3959 5225
- UK: +44 1245 491499
- Nordic Countries: +46 31 703 7173
- Worldwide: +49 8142 28640

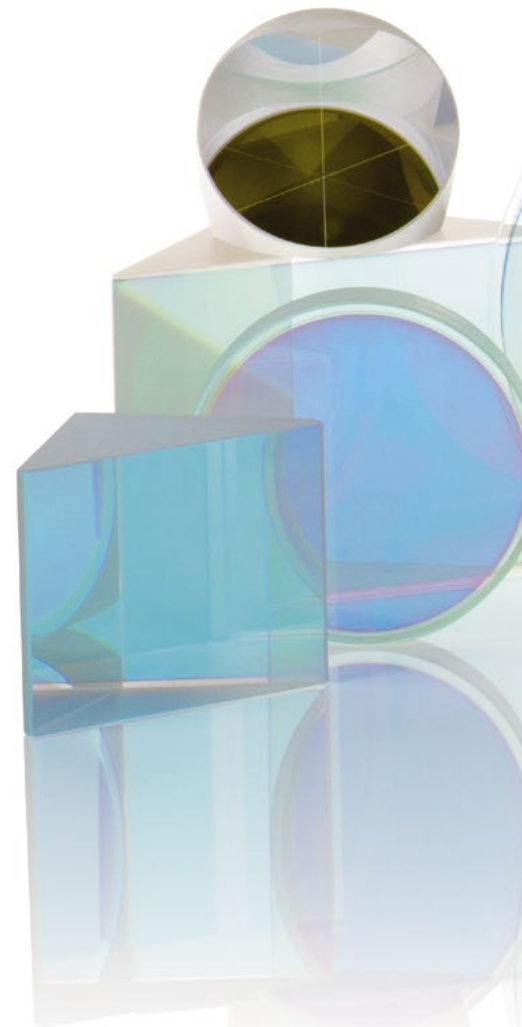



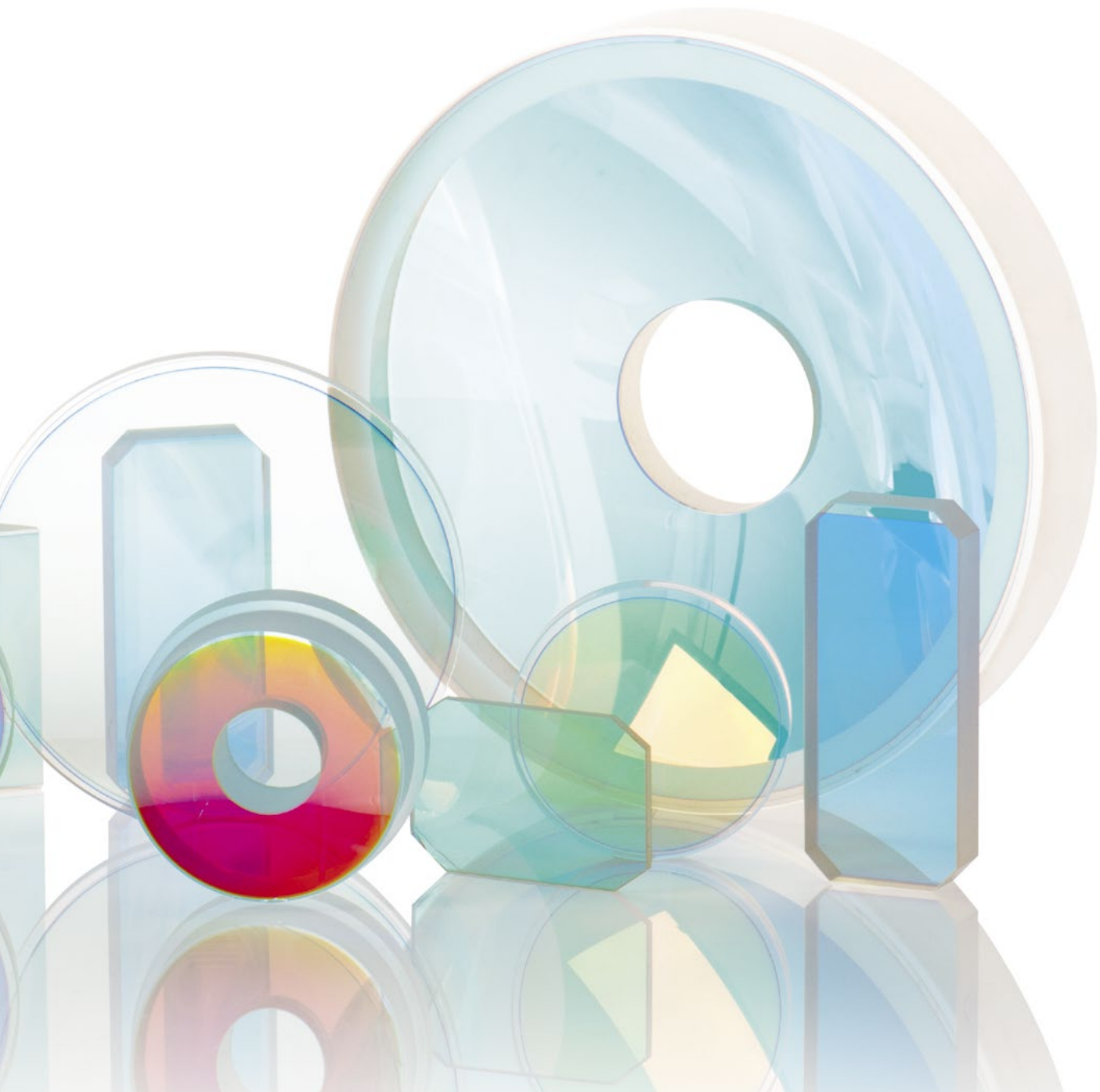

## Highly Reflective Optics



## Laser Mirror Coatings

Highly reflective end mirrors that are optimized for a normal incidence are required for the assembly of laser resonators. Dielectric mirrors with an angle of incidence (AOI) of  $45^\circ$  are commonly used for the deflection of laser beams at a right angle. Other AOI are possible upon request. Our dielectric mirrors feature high reflection values and very high laser damage thresholds.

### Trade-off table

Optimized Specification	Main Influences	Remarks
$R_{max}$	Strong substrate distortion due to stress from coating	Can be compensated if needed. Typically, IBS
Combined wavelengths	Reduced reflectivity	
LIDT $max$	Additional features as chirped mirror or large bandwidths not possible	The highest LIDT is possible for mirror at one wavelength and AOI
Bandwidth	Bending due to coating design, technique and material	Can be compensated if needed
GDD or chirped mirror	Reduced reflectivity and bandwidth	Not possible for all wavelengths

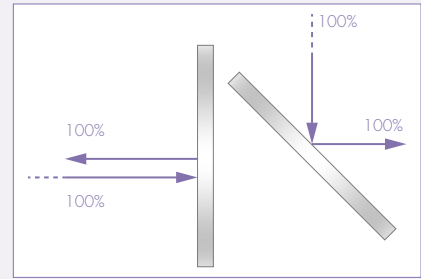

### Specifications:

Standard e-beam parameters.

Curve 1: HR 355/ $45^\circ$

$$R_s(355) > 99.7\%$$

$$R_p(355) > 99\%$$

Curve 2: HR 1064 + 532/ $45^\circ$

$$R_s(1064) > 99.8\%$$

$$R_p(1064) > 99.2\%$$

$$R_s(532) > 99.7\%$$

$$R_p(532) > 99.1\%$$

These values apply for a single wavelength (not wavelength ranges) and for one angle of incidence.

### Required information for custom designs:

Wavelengths, angle of incidence, polarization for all wavelengths, laser data, desired reflections.

### Related substrates:

Plane substrates, curved substrates

### Applications:

Resonator mirrors, bending mirrors

## Highly Reflective Optics

High reflective optics are used for reflection of a specific wavelength or wavelengths ranges.

This includes optics which only reflect certain wavelengths as well as optics that reflect beams and transmits others.

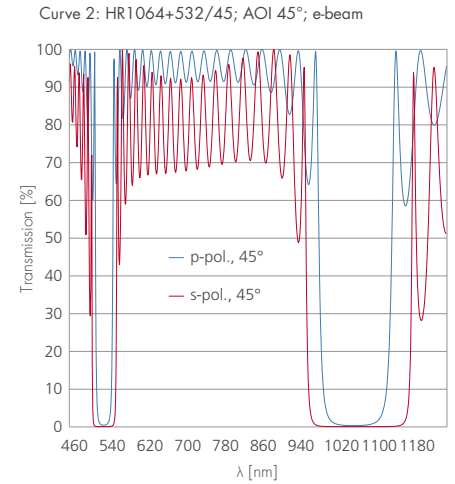
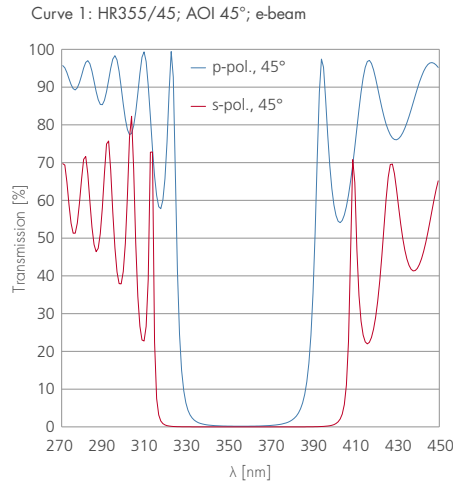

### Nomenclature:

#### Bending Mirror; Angle of Incidence 45°

HR	355	/45	PW1025UV
High Reflection coating	Wavelength in nm	Angle of incidence (AOI) in degree. If AOI is not specified, 0° is presumed.	Substrate

#### Double Bending Mirror; Angle of Incidence 0°

HR	1064 + 532	/45	PW1025UV
High Reflection coating	Wavelength in nm When several wavelengths are given, a multiple mirror coating is used.	Angle of incidence (AOI) in degree. If AOI is not specified, 0° is presumed.	Substrate

### Good to know:

Standard mirrors are optimized for a single wavelength and achieve the best reflectivity and damage threshold results. Designs for several wavelengths are also possible, however, although lower reflection values and bandwidths can result.

In particular, the effect on the damage threshold and GDD in broadband mirror designs must be considered. Special designs for scanning or applications with variable angles of incidence are also possible.

## Highly Reflective Optics



## Long-Pass/Short-Pass Coatings

Pass-mirrors are used in combination or splitting of two or more beams with different wavelengths. In a longwave pass (LPW) or long-pass coating, the long wavelengths are transmitted and the short ones reflected. A shortwave pass (SWP) or short-pass coating allows the short wavelengths to pass and reflects the long ones. A combination of LWP and SWP is possible on request.

### Trade-off table

Optimized Specification	Main Influences	Remarks
Higher reflection	Reduced transmission	
Higher transmission	Reduced reflection	
Combined wavelengths	Reflections for several wavelengths might influence transmission and vice versa	Possible in transmission and reflection
Bandwidth	Substrate deformation due to coating design, technique and material. LIDT only for one wavelength optimized	Bending can be compensated with an AR coating

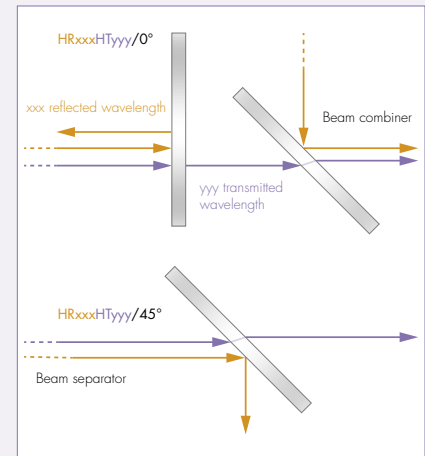

### Specifications:

HR355HT1064+532/45

$R_s(355) > 99.7\%$ ,

$R_p(355) > 99.0\%$

$T_s(1064 + 532) > 90\%$ ,

$T_p(1064 + 532) > 95\%$

The values apply for a single wavelength (not wavelength ranges) and for one angle of incidence.

### Required information for custom designs:

Wavelengths, angle of incidence, polarization for all wavelengths, laser data, desired reflections.

### Related substrates:

Plane substrates, curved substrates

### Applications:

Input coupling mirrors, output coupling mirrors, splitting or combination of different wavelengths

HR355H1064+532/45; AOI 45°; e-beam details on reflectivity

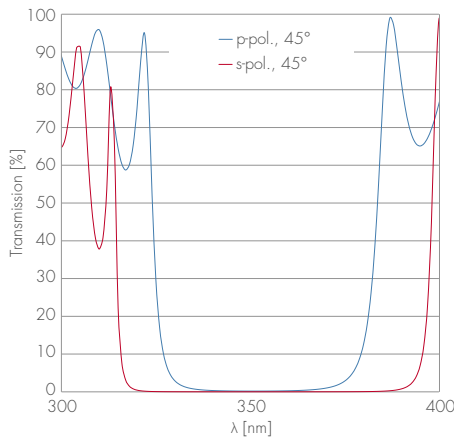

HR355H1064+532/45; AOI 45°; e-beam including transmission range

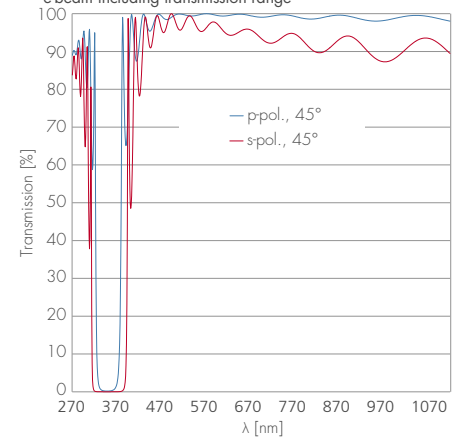

## Nomenclature:

### Dichroic; Angle of Incidence 45°

HR	355	HT	1064+532	/45	/DAR	PW1025UV
High Reflection coating	Reflected wavelength in nm	High Transmission	Transmitted wavelength(s) in nm	Angle of incidence (AOI) in degree; empty if 0°	AR coating on the rear side for the transmitted wavelengths (if desired)	Substrate

## 👍 Good to know:

The following “golden rules” will help you find the optimum combination for your application:

### 1. Bandwidth

The bandwidth of the reflected part of the beam is limited. For optimum beam splitting or combination, it is better to transmit a wavelength range and reflect single wavelengths.

Examples: HR1064HT400-700 or  
HR355HT532+1064

### 2. Polarization

The absolute degree of reflection is higher for s-polarized light than for p-polarized light, and the opposite for transmission. It is important to observe the polarization in your assembly.

### 3. Reflection is better than transmission

The efficiency of the reflected beam is higher. This should be taken into account when choosing a mirror.

### 4. Beam combination of SHG, THG, etc.\*

The corresponding portions,  $\lambda/2$ ,  $\lambda/3$ , etc., of the reflected wavelength result in a reflection peak, thus a long-pass coating is preferable.

Example: Instead of an HR1064+532HT355 coating, it would be advised to use an HR355HT532+1064 coating.

\* SHG: Second Harmonic Generation, THG: Third Harmonic Generation

## Partially Reflective Optics

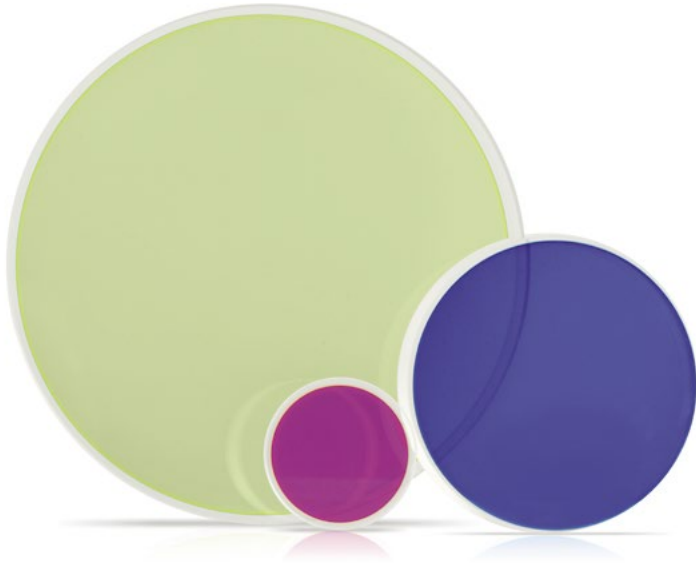

## Output Couplers

Output couplers are primarily used in resonators to couple out a laser beam. The degree of partial reflectivity has a serious effect on the quality of the resonator.

They are also used to attenuate the laser output.

### Trade-off table

Optimized Specification	Main Influences	Remarks
Improved tolerance on R	No combinations possible, higher price	Typically, with IBS or IAD
Combined wavelengths	Larger tolerance on R	Additional features large as bandwidths not possible
Bandwidth	LIDT and bending	Substrate deformation can be compensated with the AR coating

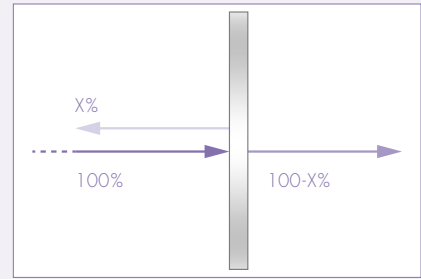

### Specifications:

The values are valid for a single wavelength (not for wavelength ranges) and for an angle of incidence of  $0^\circ$ .

- **Standard tolerance:**
  - $\pm 2\%$  for  $R < 10\%$
  - $\pm 3\%$  for  $R = 10$  to  $40\%$
  - $\pm 5\%$  for  $R = 40$  to  $60\%$
  - $\pm 3\%$  for  $R = 60$  to  $90\%$
  - $< 1\%$  for  $R > 90\%$
- **Exception 193 nm – 308 nm:**
  - $< 1\%$  for  $R < 10\%$
  - $\pm 2\%$  for  $R = 10$  to  $20\%$
  - $\pm 5\%$  for  $R = 20$  to  $80\%$
  - $\pm 2\%$  for  $R = 80$  to  $95\%$
  - $< 1\%$  for  $R > 95\%$  (except for 193 nm)

### Required information for custom designs:

Wavelengths, laser data, and desired reflections.

### Related substrates:

Plane substrates, curved substrates.

### Applications:

Resonator output coupler.

## Partially Reflective Optics

Partially reflective optics are used in the output coupling or splitting of a specific wavelength.

At an angle of incidence of  $0^\circ$ , the optics are referred to as output couplers, and at an AOI of  $45^\circ$  they are referred to as a standard beam splitter.

PR1064 20%, 50%, 90%; AOI  $0^\circ$  with different R values; e-beam

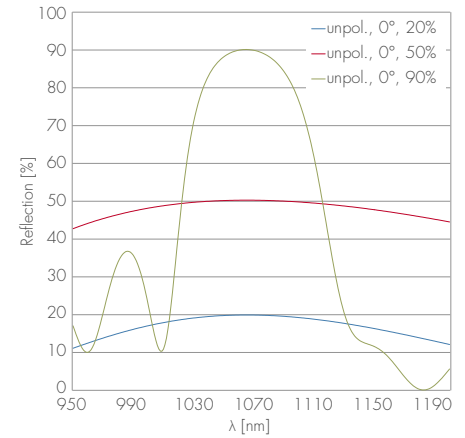

### Nomenclature:

#### Output Coupler; Angle of Incidence $0^\circ$

PR	1064	/90	/AR	SM07-1.00C
Partially Reflective coating	Wavelength in nm	Reflection in %	AR coating on the rear side (if desired)	Substrate

### 👍 Good to know:

Standard output couplers are optimized for a single wavelength and achieve the best bandwidth, and damage threshold results. Designs for several wavelengths are also possible, however, these designs often have low tolerances and smaller bandwidths.

The rear side of the output couplers commonly features an AR coating to minimize transmitted beam losses.

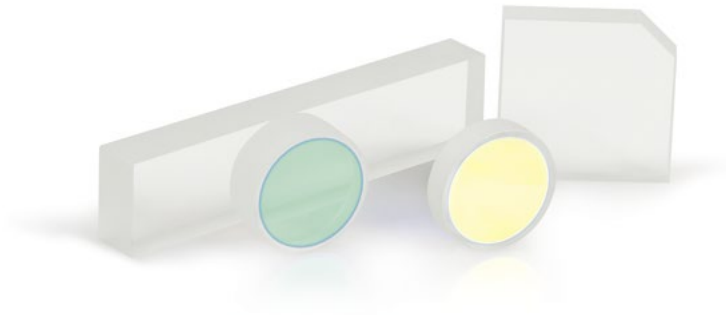

## Standard Beam Splitters

These optics are primarily used in external beam guidance to separate the beam into two defined parts. The angle of incidence for standard beam splitters is typically  $45^\circ$ , however, other angles are also possible on request.

### Trade-off table

Optimized Specification	Main Influences	Remarks
Improved tolerance on R	No combinations possible, higher price	Typically, with IBS or IAD
Combined wavelengths	Larger tolerance on R	Additional features as large bandwidths not possible
Bandwidth	LIDT and bending	Substrate deformation can be compensated with the AR coating
Polarization independent	Depends on bandwidth	See next page

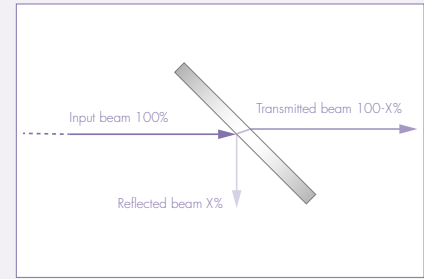

### Specifications:

All values apply for a single wavelength (not wavelength ranges), one angle of incidence, and one polarization at an AOI not equal to 0.

- **Standard tolerance:**
  - $\pm 2\%$  for  $R < 10\%$
  - $\pm 3\%$  for  $R = 10$  to  $40\%$
  - $\pm 5\%$  for  $R = 40$  to  $60\%$
  - $\pm 3\%$  for  $R = 60$  to  $90\%$
  - $< 1\%$  for  $R > 90\%$
- **Exception 248 nm – 308 nm:**
  - $< 1\%$  for  $R < 10\%$
  - $\pm 2\%$  for  $R = 10$  to  $20\%$
  - $\pm 5\%$  for  $R = 20$  to  $80\%$
  - $\pm 2\%$  for  $R = 80$  to  $95\%$
  - $< 1\%$  for  $R > 95\%$

### Required information for custom designs:

Wavelengths, angle of incidence, polarization for all wavelengths, laser data, and desired reflections.

### Related substrates:

Plane substrates

### Applications:

Splitting laser beams in two parts



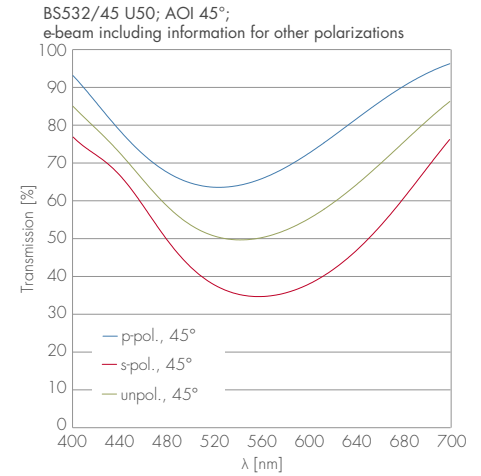
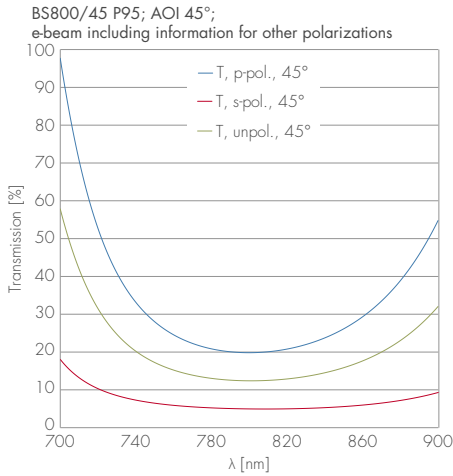

#### Nomenclature:

Beam Splitter; Angle of Incidence 45°

BS	532	/45	U50	/AR	PW1025UV
Beam Splitter coating	Wavelength in nm	Angle of incidence in degree	Reflection in % for the specified polarization (u-, s-, or p-pol)	AR coating on the rear side (if desired)	Substrate

#### 👍 Good to know:

In standard coatings, the degree of reflection is normally guaranteed for one polarization.

A standard beam splitter that is manufactured for R=50% s-pol can have a different degree of reflectivity for p-pol radiation or unpolarized light. The results shown in the simulation curve are common but not guaranteed.

In particular, the effect on the damage threshold and GDD on broadband beam splitters must be considered. The rear side of all beam splitters commonly include an AR coating to minimize transmitted beam losses.

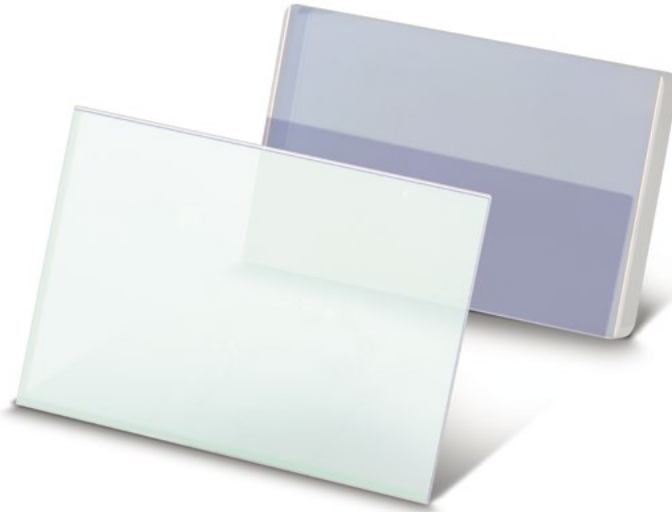

# Polarization-Independent Beam Splitters

Polarization-independent beam splitters are optimized for use with circularly polarized light because an identical degree of reflection can be achieved for each polarization direction. The figure shows the coating for  $R_s = R_p = 50\%$ . Polarization independent beam splitters can be manufactured in the wavelength range from 355 nm to 1064 nm.

### Trade-off table

Optimized Specification	Main Influences	Remarks
Improved tolerance on R	No combinations possible, higher price	Typically, with IBS or IAD
Combined wavelengths		No combination possible
Bandwidth	LIDT and bending	Substrate deformation can be compensated with the AR coating No large bandwidth possible

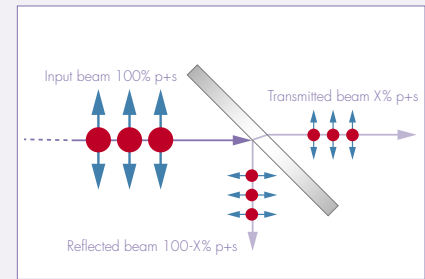

### Specifications:

- Degree of reflection:**  
 e.g.  $R = 50 \pm 3\%$  for 532 nm  
 Difference between s- & p-pol:  $< 3\%$   
 Other specifications are available upon request.
- Back reflection:**  
 with AR coating  
 (optimized for s- and p-pol):  
 $R < 0.6\%$  p-pol,  
 $R < 0.4\%$  s-pol

### Required information for custom designs:

Wavelength, desired reflections, laser data and angle of incidence.

### Related substrates:

Plane substrates

### Applications:

Beamsplitting if e.g. circularly polarized beam shall not be destroyed

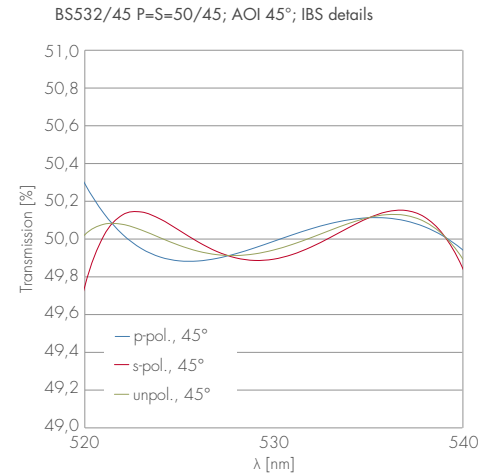
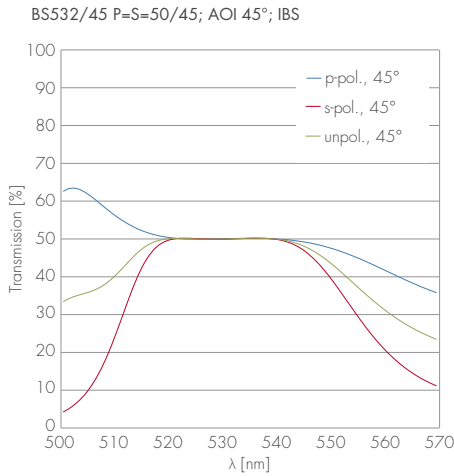

### Nomenclature:

Beam Splitter; Angle of Incidence 45°;  $R_p = R_s$

BS	1064	/45	S=P50	/AR	PW1025UV
Beam Splitter coating	Wavelength in nm	Angle of incidence in degrees	Reflection in % (for s- and p-pol)	AR coating on the rear side (if desired)	Substrate

### 👍 Good to know:

These designs can be optimized only for one wavelength and one angle of incidence.

The rear side AR coating is also optimized for s- and p-pol.

## Thin-Film Polarizers

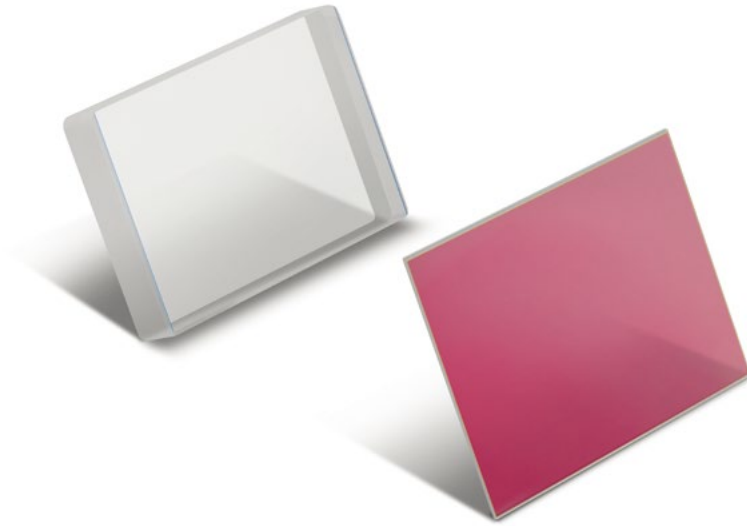

## Standard Thin-Film Polarizers

Standard thin-film polarizers are ideally assembled typically at Brewster's angle, which is approximately  $56^\circ$ . The extinction ratio is achieved without adjusting the angle of incidence as long as it lies in the range of  $54^\circ$  to  $58^\circ$ . Only at wavelengths of less than 500nm can the acceptance angle be somewhat lower to achieve extinction. The extinction ratio can be improved by restricting the range of the angle of incidence.

### Trade-off table

Optimized Specification	Main Influences	Remarks
Better extinction ratio	Limited AOI range	Only for one wavelength
Higher $R_s$	Limited AOI range or reduced $T_p$	
Higher $T_p$	Limited AOI range or reduced $R_s$	
LIDT max	Only for one AOI and wavelength	

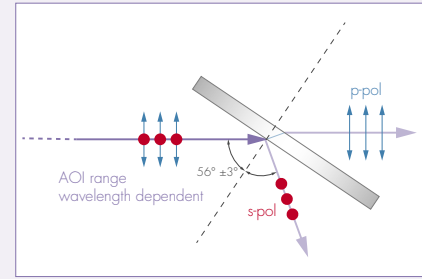

### Specifications:

- **Angle of incidence:**  $56^\circ$   
No adjustment is necessary.
- **Reflection:**  $R_s > 99,5 \%$
- **Transmission:**  
532; 1064 nm:  $T_p > 97 \%$   
355 nm:  $T_p > 93 \%$
- **Standard wavelengths:**  
515 nm, 532 nm, 1030 nm,  
1047 nm, 1053 nm, 1064 nm  
exact specification upon request.  
Further wavelengths are available  
upon request.

### Required information for custom designs:

Wavelength, optimization on s- or p-pol if requested, laser data.

### Related substrates:

Plane substrates, waveplates

### Applications:

Adjustable beam attenuation with waveplate

## Thin-Film Polarizers

Polarizers are used for polarization separation. In addition to cube polarizers and well-known Glan Taylor polarizers made of calcite or alpha BBO, so-called thin-film polarizers are used on glass substrates to withstand the all-time highest power densities. LASER COMPONENTS offers a selection of three different polarizers.

**General note:** When using or assembling thin-film polarizers, it is important to note that the p-polarized beam experiences a slight beam shift and that the s-polarized beam is deflected.

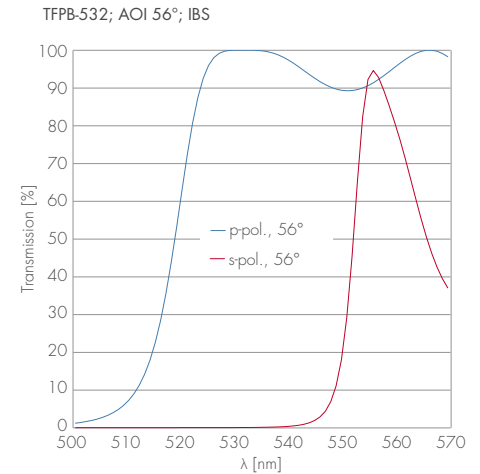

### Nomenclature:

#### Thin-Film Polarizer; Angle of Incidence 56°

TFPB	-532	RW28.6-14.3-3.2UV
Thin Film Polarizer	Wavelength in nm	Substrate

### 👍 Good to know:

These optics are equipped with a dielectric coating on one side. This special coating results in a high reflection for s-polarized light at a simultaneously high transmission for p-polarized light. Because it is used at the Brewster angle, primarily at

p-polarized light, the backside does not require a coating.

Due to its comparably simple coating design, standard thin-film polarizers have the highest damage threshold.

## Thin-Film Polarizers

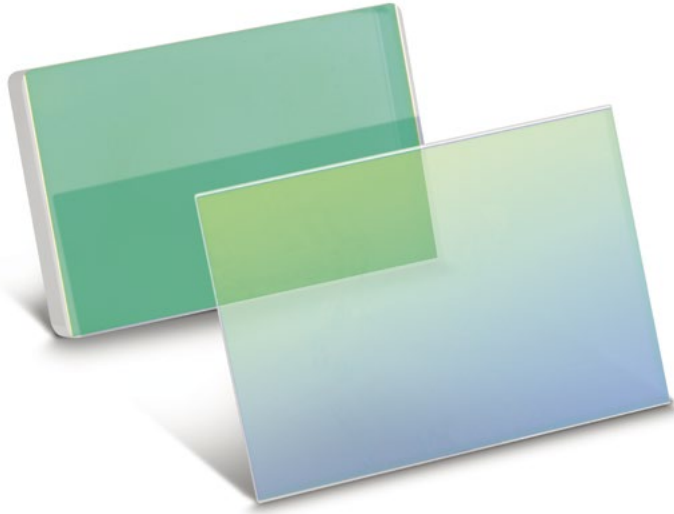

## 45° Thin-Film Polarizers

These polarizers are used at an angle of incidence of 45°. Because the reflected s-pol beam is deflected at a right angle, they can be used with standard mounts for 90° bending mirrors. This allows them to be integrated simply and inexpensively into different systems.

### Trade-off table

Optimized Specification	Main Influences	Remarks
Better extinction ratio	Limited AOI range	Only for one wavelength
Higher $R_s$	Limited AOI range or reduced $T_p$	
Higher $T_p$	Limited AOI range or reduced $R_s$	

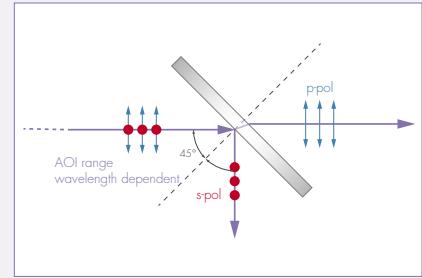

### Specifications:

- **Angle of incidence:**  $45 \pm 1^\circ$   
No adjustment is necessary.
- **Reflection:**  
1064 nm:  $R_s > 99.5\%$
- **Transmission:**  
1064 nm:  $T_p > 95\%$
- **Standard wavelengths:** 1064 nm  
Further wavelengths are available upon request.

### Required information for custom designs:

Wavelength, laser data

### Related substrates:

Plane substrates, waveplates

### Applications:

for separation of polarization with perpendicular bending of s-pol

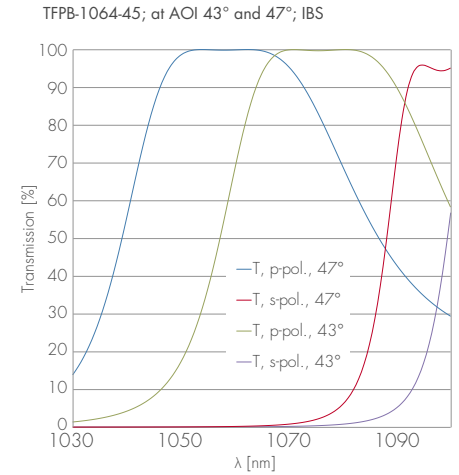
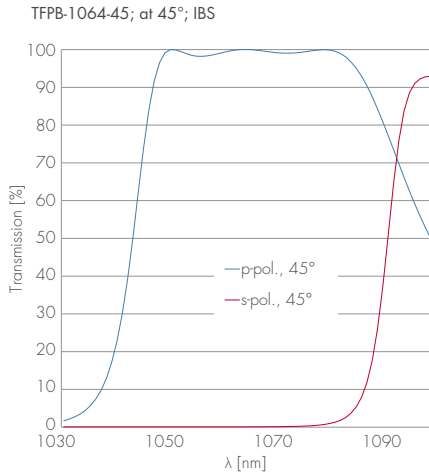

### Nomenclature:

Thin-Film Polarizer; Angle of Incidence 45°

TFPB	-1064	-45	/AR	PW1012UV
Thin Film Polarizer	Wavelength in nm	Angle of incidence (AOI) in degree	Coating on the rear side	Substrate

### 👍 Good to know:

The 45° polarizers feature a coating that is optimized for p-pol. By deflecting the s-polarized beam by 90°, the subsequent beam path does not require special mounts; however, this is only possible at the cost of the extinction ratio,

angle dependency, and damage threshold.

As those TFP's are not used at the brewster angle, a rear side AR coating for p-pol can be included.

## Thin-Film Polarizers

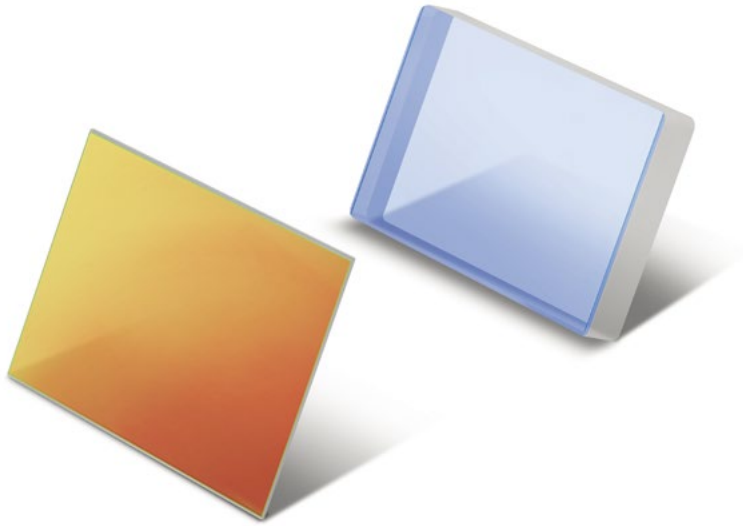

## Broadband Thin-Film Polarizers

Broadband thin-film polarizers with low dispersion are particularly well suited for polarization separation in broadband systems, such as Ti:sapphire fs lasers. They have the same coating on both sides and so can be used in both directions.

### Trade-off table

Optimized Specification	Main Influences	Remarks
Better extinction ratio	Limited AOI range	Only for one wavelength
Higher $R_s$	Limited AOI range or reduced $T_p$	
Higher $T_p$	Limited AOI range or reduced $R_s$	

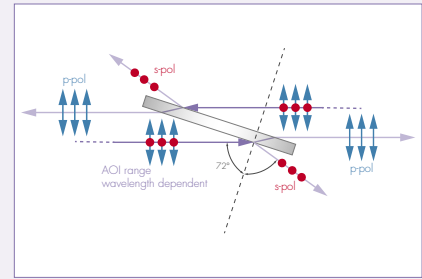

### Specifications:

- **Angle of incidence:**  $72^\circ \pm 2^\circ$

To reach the best possible extinction ratio, the angle has to be adjusted within this range.

- **Transmission:**

$T > 98\%$  per surface for p-pol

- **Reflection:**

$R > 75\%$  per surface for s-pol

Higher values can be reached in reflection, however, this increase causes the transmission value to decrease for p-pol light.

- **Standard wavelengths:**

790 nm, 800 nm

Coatings for additional wavelengths are available upon request.

### Required information for custom designs:

Wavelengths, laser data

### Related substrates:

Plane substrates

### Applications:

Separation of polarization for broadband beams



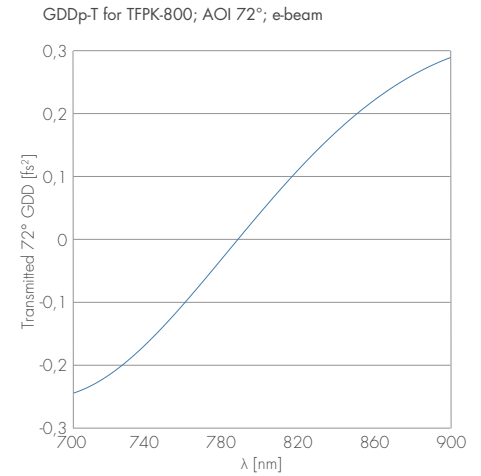
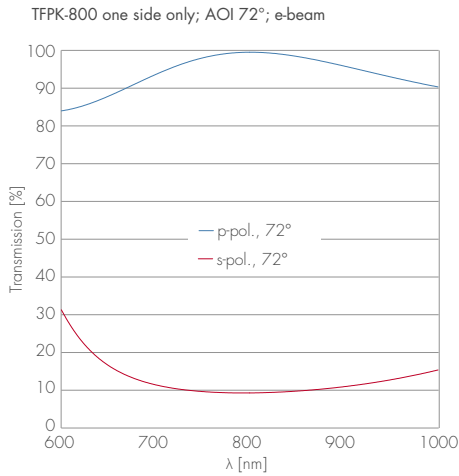

### Nomenclature:

Broadband Thin-Film Polarizer; Angle of Incidence 72°

TFPK	-800	PW1008UV
Broadband low dispersion polarizer	Wavelength in nm	Substrate

### 👍 Good to know:

The system should be designed in such a way that the p-polarized beam experiences a beam shift and the s-polarized beam is deflected by 144°.

As this optic has the same coating on both sides, the flatness after coating is comparable to the uncoated substrate.

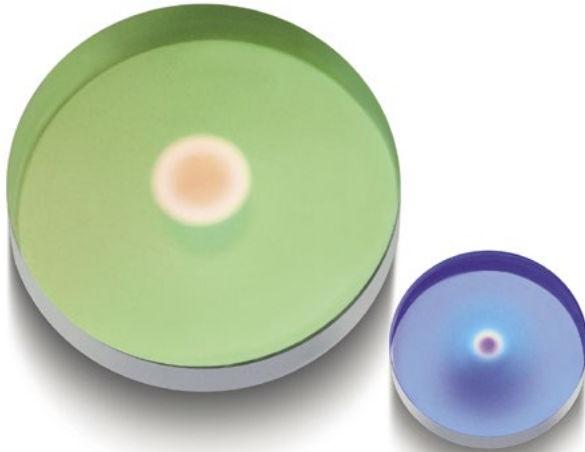

# Gaussian Mirrors

Gaussian mirrors, which are also referred to as variable reflecting mirrors (VRMs), are characterized by a degree of reflection that diminishes from the center of the optic at a Gaussian curve. In addition to LASER COMPONENTS, only a handful of other suppliers offers these special mirrors worldwide.

These mirrors provide unstable resonators with a high-quality laser beam that exhibits a low beam divergence at a high pulse energy. In frequency-doubled systems, they are used to produce a higher pump efficiency. Gaussian mirrors are characterized by high laser stability and are thus suited for the highest power levels.

### Specifications:

- **Formula:**

$$R(r) = R_0 \cdot \exp \left[ -2 \left( \frac{r}{W} \right)^n \right] + R_{out}$$

- **Reflection values  $R_0$ ,  $R_{out}$ :**

Two important parameters are the reflection values in the outer and central zone (see figure below).

All coatings where  $R_0 > R_{out}$  are defined as Gaussian mirrors; this contains the so-called Super Gaussian Mirrors with a Gaussian order greater than 2. It is often assumed that  $R_{out} = 0$ ; however, other values can be specified. For reflection in the central zone, it is possible to specify values up to 90 %.

- **Lateral dimension  $w$ :**

The lateral dimension  $w$  is half the diameter of the spot and is defined by the position  $1/e^2$ .

- **Gaussian order  $n$ :**

The Gaussian order  $n$  is the exponent of the Gaussian function. With it, the slope and shape can be determined.

- **Working wavelength  $\lambda$ :**

Dielectric coatings with a defined reflection function  $R(r)$  are generally monochromatic. The Gaussian profile is only valid for a single specified wavelength.

LASER COMPONENTS has Gaussian mirrors for 1064 nm available as standard basis. Additional wavelengths can be manufactured upon request.

▪ **Laser beam parameters:**

For cw lasers: laser power density in  $W/cm^2$

For pulsed lasers: energy density in  $J/cm^2$  and pulse length as well as repetition rate

▪ **Standard tolerances:**

$w \pm 10\%$ ,  $n \pm 10\%$ ,

$R \pm 2\%$ ,  $R_{out} < 0.2\%$

**Required information for custom designs:**

**Related substrates:**

Plane substrates, curved substrates

**Applications:**

Output optics for instable Resonator

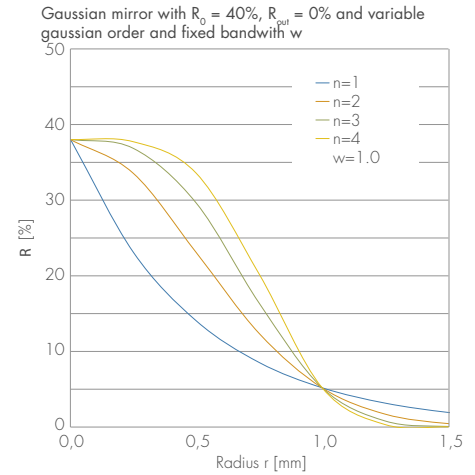
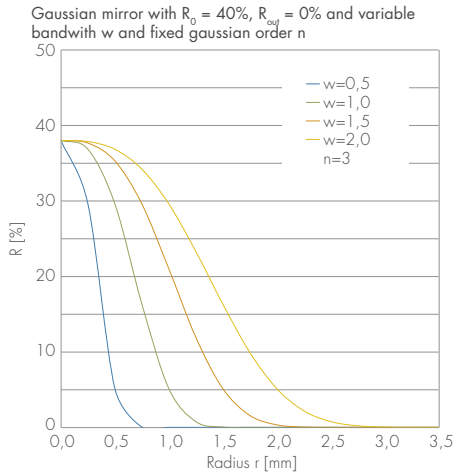

**Nomenclature:**

**Gaussian Mirror; Angle of Incidence 0°**

GR	1064	/35	-1.3	-4	CX1025-4.0UV
Gaussian mirror	Wavelength in nm	$R_0$ : Reflectivity in center area in %	w: Radius $1/e^2$	n: Order	Substrate

**Good to know:**

An AR coating is applied to the front, outside of the Gaussian spot, as well as to the rear side on a standard basis.

The spectral measurement of a gaussian mirror is done at a special test setup on the substrate not on a witness sample.



## V-AR and U-AR Coatings

The majority of AR coatings are optimized coatings that provide a minimal coating for a single wavelength.

Following the shape of the coating curves, one can differentiate between narrow-banded V-AR coatings over U-AR coatings that have a spectrally wider effect. Moreover, the U-AR coatings have a lower residual average reflection; however, their damage threshold is lower and they are somewhat more expensive to manufacture.

### Trade-off table

Optimized Specification	Main Influences	Remarks
Reduced R	Reduced bandwidth	
Bandwidth	Higher R	
Combined Wavelengths	Higher R	

### Specifications:

- **Reflection:**

At AOI 0°:

$R < 0.2\%$  for VIS and NIR

$R < 0.3\%$  for UV

### Required information for custom designs:

Wavelengths, angle of incidence, polarization, laser data

### Related substrates:

Plane substrates, lenses, waveplates

### Applications:

To reduce reflection losses for windows, lenses, prism, waveplates and on rear side of SWP-/LWP-optics, output couplers and beam-splitters

## AR-Coatings

Anti-Reflection (AR) coatings are used on windows and lenses or on the rear side of dichroic mirrors and beam splitters.

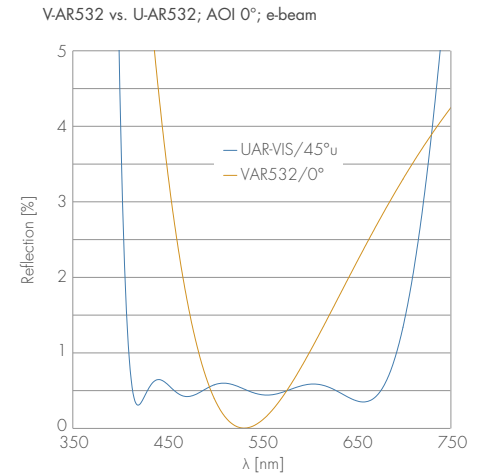
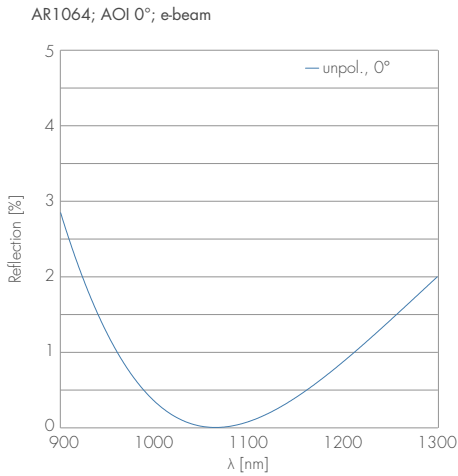

### Nomenclature:

V-AR and U-AR Coating; Angle of Incidence 0° or 45°

AR/AR	1064	PLCX-25.4/51.5C
Anti-Reflection coating on both sides	Wavelength in nm	Substrate

### 👍 Good to know:

In AR coatings for an angle of incidence  $\neq 0^\circ$ , the design can be optimized for a specific polarization.

In the absence of any special requirements, the design is commonly optimized for unpolarized light.



## BBAR/DAR Coatings

If optimum coatings are required for a wide wavelength range or several wavelengths, special multi-layered, dielectric coatings are necessary. With the help of even a single coating, an AR coating of 10–20 layers for a wide wavelength spectrum or several single wavelengths can be produced.

### Trade-off table

Optimized Specification	Main Influences	Remarks
Reduced R	Reduced bandwidth	
Bandwidth	Higher R	
Combined Wavelengths	Higher R	

### Specifications:

- **Reflection BBAR's 0°:**  
 $R < 0.4 \%$  average (except for UV)  
 $R < 0.5 \%$  average for UV  $< 400 \text{ nm}$
- **Reflection DAR 0°:**  
 $1064 \text{ nm}: R < 0.4 \%$   
 $532 \text{ nm}: R < 0.3 \%$   
 or  
 $1064 \text{ nm}: R < 0.3 \%$   
 $532 \text{ nm}, 355 \text{ nm}: R < 1 \%$   
 $266 \text{ nm}: R < 2 \%$

### Required information for custom designs:

Wavelengths, angle of incidence, polarization, laser data

### Related substrates:

Plane substrates, lenses

### Applications:

To reduce reflection losses for windows, lenses, prism, waveplates and on rear side of SWP-/LWP-optics, output-couplers and beam-splitters

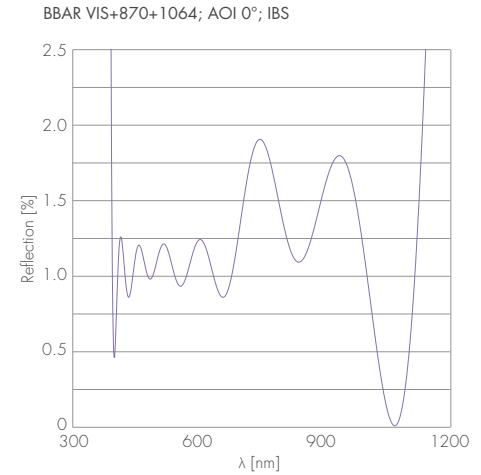
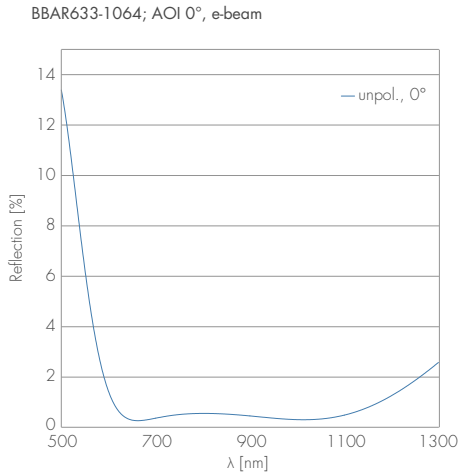

#### Nomenclature:

Broadband Antireflective Coating; Angle of Incidence 0° or 45°

BBAR	633 – 1064	/45	PW2037UV
Broadband Antireflective coating	Wavelength range in nm	Angle of incidence (AOI) in degree. If AOI is not specified, 0° is presumed.	Substrate

Multiple Antireflective Coating; Angle of Incidence 0° or 45°

DAR	1064 & 532	/45	PP0525UV
Double Antireflective coating	Wavelength in nm	Angle of incidence (AOI) in degree. If AOI is not specified, 0° is presumed.	Substrate

#### 👍 Good to know:

These coatings are also available as standard for an angle of incidence of 0° and 45°. Upon request, we also manufacture coatings for other AOIs.

At an angle of incidence of 45°, it is possible to achieve an optimization for the various polarizations (u-pol, s-pol, or p-pol).

# SUBSTRATES

Send us an email or give us a call!

[info@lasercomponents.com](mailto:info@lasercomponents.com)

- Germany: +49 8142 28640
- USA: +1 603 821 7040
- France: +33 1 3959 5225
- UK: +44 1245 491499
- Nordic Countries: +46 31 703 7173
- Worldwide: +49 8142 28640







# Glass Materials

Typical Transmission Range

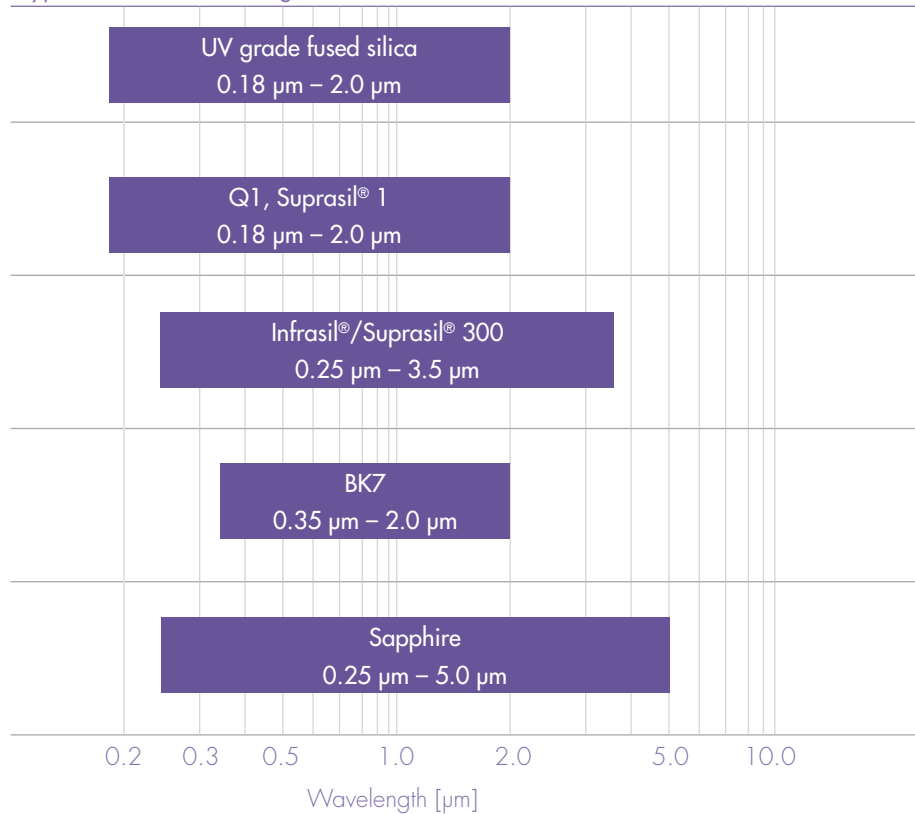



### Description

- |  |
|--|
| <ul style="list-style-type: none"> <li>▪ Commonly used material for high power laser applications</li> <li>▪ Good transmission values from the UV to NIR range</li> <li>▪ High stability and low thermal expansion coefficient</li> </ul>  |
| <ul style="list-style-type: none"> <li>▪ Fused silica with high purity and excellent homogeneity</li> <li>▪ Low metallic impurities, therefore high UV transmission &amp; minimum fluorescence</li> <li>▪ No polishing marks and striae</li> </ul>   |
| <ul style="list-style-type: none"> <li>▪ Fused silica for IR applications to 3500 nm</li> <li>▪ Specially treated / manufactured fused silica with &lt; 1 ppm OH contents</li> <li>▪ No absorption effects at 2700 nm due to low OH content</li> <li>▪ Reduced UV transmission (due to higher metallic contamination)</li> </ul> |
| <ul style="list-style-type: none"> <li>▪ Borosilicate crown glass</li> <li>▪ Most commonly used material in laser optics</li> <li>▪ Excellent quality at a low price</li> <li>▪ Easy to process and to polish to high accuracy</li> </ul>  |
| <ul style="list-style-type: none"> <li>▪ Synthetic, monocrystalline aluminium oxide</li> <li>▪ Optically strongly anisotropic, shows birefringent effects</li> <li>▪ Performance depends on orientation of optical axis</li> <li>▪ High mechanical strength, chemical resistance and thermal stability</li> </ul>                |

# PLANE SUBSTRATES

Substrates with flat surfaces are used in laser technology, for example, as resonator optics, bending mirrors, short-pass or long-pass mirrors and windows. These plano-substrates vary in their wedge angle specification and are available in various sizes and shapes.



#### Specifications:

- **Material:** BK7, fused silica
- **Wedge:**  
PW/PS-window  $\leq 5$  arcmin  
PP-window  $\leq 20$  arc sec.
- **Diameter tolerance:**  $+0/-0.2$ mm
- **Thickness tolerance:**  $\pm 0.2$ mm
- **Clear aperture:**  $>85\%$  of diameter
- **Surface quality:**  
 $5/4 \times 0.025$  for 1" equals S-D 10 – 5 S-D before coating
- **Surface figure:**  
 $\lambda/10$  (BK7, UVFS for 1" substrates) before coating and for thickness  $> 6$  mm
- **Chamfer:**  
 $0.2-0.4 \times 45^\circ$

**Note:** Specification for other materials and sizes upon request.

#### Related products:

HR, HRHT, PR, BS, GR, AR, TFP

#### Plane Substrates

Type	Round	Rectangular
Plane Window	PW	RW
Plane parallel window	PP	RP
Plane mirror substrate	PS	RS
Grinded rearside	PU	RU
Interferometer flat	PI	RI
Wedge	PLx	RLx

#### Nomenclature PW, PP, PS, PI, PU, PLx:

PW	05	12	UV
Product code (Plane Window)	Diameter in inches x10	Thickness in inches x100	Material code UV: fused silica C: BK7 SA: sapphire

#### Nomenclature RW, RW, RS, RI, RU, RLx

RW	28.6	-14.3	-3.2	UV
Product code (Rectangular Window)	Length in mm	Width in mm	Thickness in mm	Material code UV: fused silica C: BK7 SA: sapphire

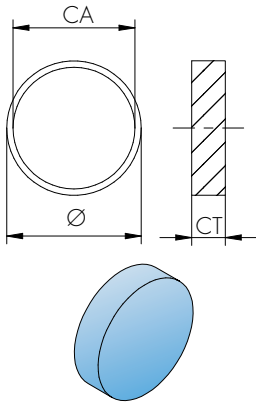

## PW or RW Series Plane Windows

The PW/RW series is the most widely used range of optics. They are used to split transmitted laser beams, for example in dichroic mirrors, input and output couplers, beam splitters, and windows.

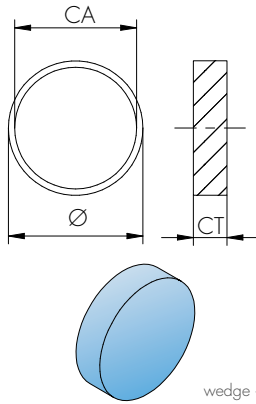

## PP or RP Series Plane Parallel Windows

The PP/RP series features a very small wedge angle. These windows are used where the angular deflection of the transmitted beam is imperative, for example in output couplers or beam splitters. The plane parallel windows can be exchanged without having to readjust the system.

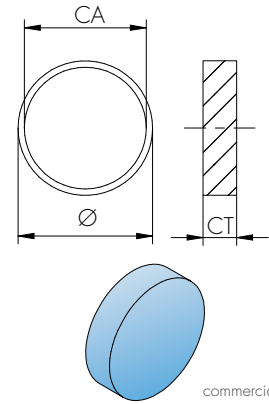

## PS or RS Series Plane Mirror Substrates

The PS/RS series is used if only one high-quality laser substrate surface is required. This series has standard specifications while the rear side remains uncoated.

These mirror substrates are an inexpensive alternative, especially for optics larger than 50 mm.

wedge <20arcsec

rear side  
commercial polished

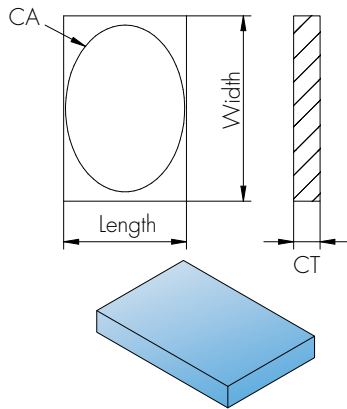

## PU/RU Series Plane Mirror Substrates with Grinded Backside

For special applications, it may be necessary for the rear side to be grinded; however, this may make it difficult to test the cleanliness of the raw substrates. Consequently, they are not suited for critical components.

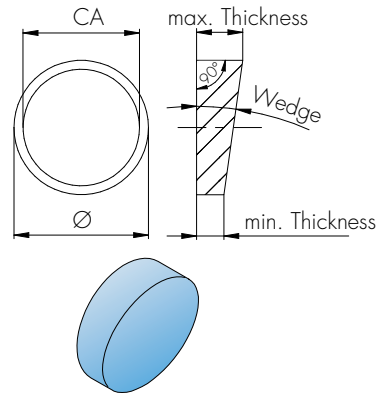

## PI, RI, PL, or RL Series Wedge Substrates

If the laser beam has to be deflected by a very small angle in transmission, wedge windows are used. Furthermore, they are used as mirrors or output couplers if, despite the AR coating, rear side reflections occur that lead to ghost beams and adversely affect the application.

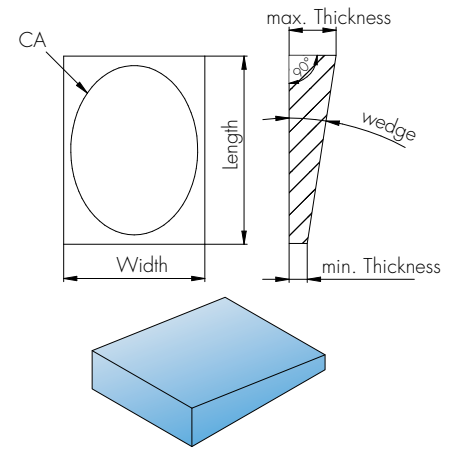

PI and RI substrates have a wedge angle of  $0.5^\circ$ . In PL or RL substrates, the angle is larger or can be defined by the customer.

### 👍 Good to know:

It goes without saying that the correct specification on substrate quality and material is imperative in laser optics. On one side the high quality is needed to achieve ultimate performance in the use, however, without care, a tight specification can increase the price without any benefit.

For optimum selection, please feel free to contact us. A rule of thumb of 1:4 for the diameter to thickness ratio to achieve flatness of better  $\lambda/10$  on fused silica.

# Spherical Substrates



LASER COMPONENTS differentiates between two types of spherical substrates:

## **Mirror Substrates**

Mirror substrates are commonly used in the resonator as a mirror or for input and output coupling. They have a higher center thickness than lenses to counteract possible deformation caused by the application of dielectric coatings. All curved mirror substrates are finely polished on both sides as standard to be able to use them for dichroic mirrors and output couplers.

## **Lenses**

Inexpensive plano-convex and plano-concave lenses are commonly used in laser technology. These lenses have a higher spherical aberration than lenses with two curved surfaces at the same focal length, however, due to the small beam diameter, this aberration is, for the most part, is negligible in laser technology.



### Specifications:

- **Material:** BK7, fused silica, sapphire
- **Diameter tolerance:**  
+ 0.00 mm; - 0.20 mm
- **Thickness tolerance:**  $\pm 0.20$  mm
- **Radii tolerance:**  
 $\pm 0.5\%$  for  $r_{cc}/r_{cx} < 0.5$  m  
 $\pm 1\%$  for  $0.5$  m  $< r_{cc}/r_{cx} < 2$  m  
*For radii larger than 2 m please check with our sales department.*
- **Clear aperture:**  $> 85\%$  of diameter
- **Surface figure\*:**  
*Curved surface:*  
3/-(0.2/-) according to ISO 10110  
*Plane surface:*  
3/0.2(0.2/-) according to ISO 10110  
 $\lambda/10$  according to MIL-O-1380A
- **Surface quality\*:**  
5/4 x 0.025 for 1.0" substrates according to ISO 10110  
10-5 according to MIL-O-1380A
- **Centering error:**  
4/3' according to ISO 10110
- **Protective chamfer:**  
0.2 – 0.4 mm x 45°

\* not valid for sapphire

### Spherical Substrates

#### Type

Concave mirror substrate	SM
Convex mirror substrate	SMX
Plano convex lens	PLCX
Plano concave lens	PLCC
Bi-convex lens	BICX
Bi-concave lens	BICC

### Nomenclature Curved Mirror Substrates:

SM	05	- 0.10	C
Product code (Spherical Concave Mirror Substrates)	Diameter in inches x10 and ET 9.5 mm	Concave radius of curvature in m	Material code UV: fused silica C: BK7 SA: sapphire

SM	05	25	- 0.10	C
Product code (Spherical Concave Mirror Substrates)	Diameter in inches x10	Edge thickness in inches x100	Concave radius of curvature in m	Material code UV: fused silica C: BK7 SA: sapphire

### Nomenclature Spherical Lenses:

PLCX	-25.4	/51.5	C
Product code (Plano Convex Lens)	Diameter in mm	Convex radius of curvature in mm	Material code UV: fused silica C: BK7 SA: sapphire

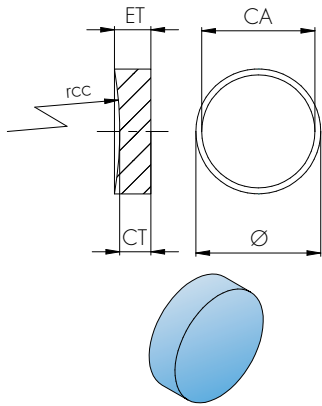

## SM Series

### Concave Mirror Substrates

Concave mirror substrates are commonly used in resonators. The concave surface allows resonators to be implemented that are insensitive to adjustment.

$$f = \frac{r_{cc}}{2}; \text{ if used as a mirror}$$

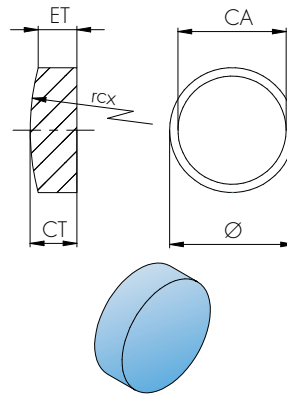

## SMX Series

### Convex Mirror Substrates

Convex mirror substrates are used for resonance structures.

$$f = \frac{r_{cx}}{2}; \text{ if used as a mirror}$$

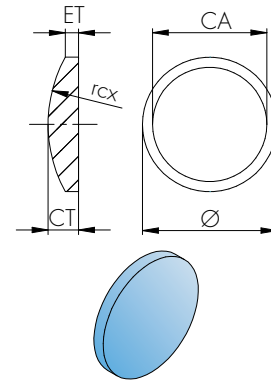

## PLCX Series

### Plano-Convex Lenses

Plano-convex lenses are so-called positive lenses. They are primarily used in the focusing of laser beams, for images with long focal lengths, and beam expansion.

$$f = \frac{r_{cx}}{(n-1)}; \text{ if used as a lens}$$

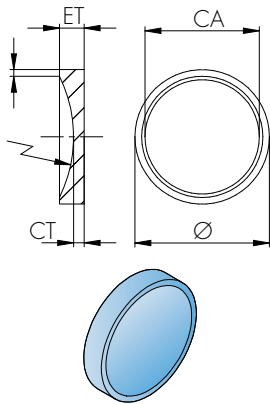

## PLCC Series Plano-Concave Lenses

Plano-concave lenses are so-called negative lenses. In laser technology, they are primarily used in beam expansion.

$$f = \frac{r_{cc}}{(n-1)}; \text{ if used as a lens}$$

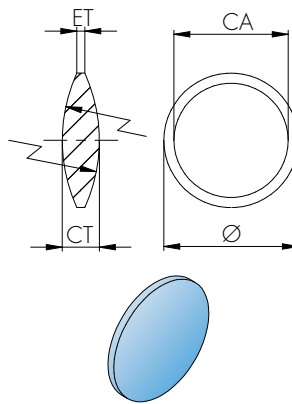

## BICX Series Biconvex Lenses

Biconvex lenses are positive lenses with two equal curvature radii. In laser technology, they are primarily used if very short focal lengths are required that cannot be achieved with a plano-convex lens.

$$f = \left[ \frac{2(n-1)}{r_{cx}} - \frac{CT(n-1)^2}{n(r_{cx})^2} \right]^{-1}$$

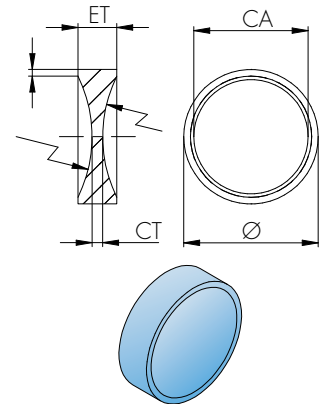

## BICC Series Biconcave Lenses

Biconcave lenses are so-called negative lenses with two equal curvature radii. In laser technology, they are primarily used if very short negative focal lengths are required that cannot be achieved with a plano-concave lens.

$$f = \left[ \frac{2(n-1)}{r_{cc}} - \frac{CT(n-1)^2}{n(r_{cc})^2} \right]^{-1}$$

### 👍 Good to know:

Generally, lens substrates can also be used for mirrors while curved mirror substrates can also be used for lens applications. It is important to ensure that the substrate thickness is not too thin.

Thicker mirror substrates are less sensitive to deformation, also due to the one-sided coating; however, the use of these substrates in transmission can result more easily in temperature effects.

# Cylindrical Lenses

Cylindrical lenses are used in line generation or beam expansion in one axial direction. The optical properties and aberrations correspond to those of spherical optics.

LASER COMPONENTS offers cylindrical lenses that are rectangular, square, and round. The cylinder axis of rectangular and square cylindrical lenses are clearly defined by their straight edge, whereas round cylindrical lenses are somewhat more complex to identify, unless they are factory mounted in a standard lens mount.

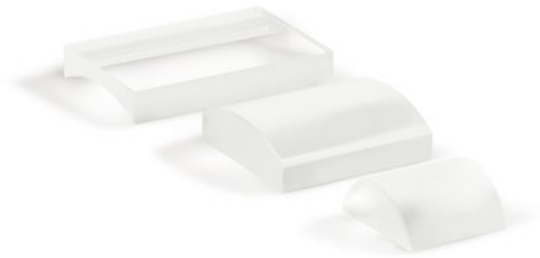

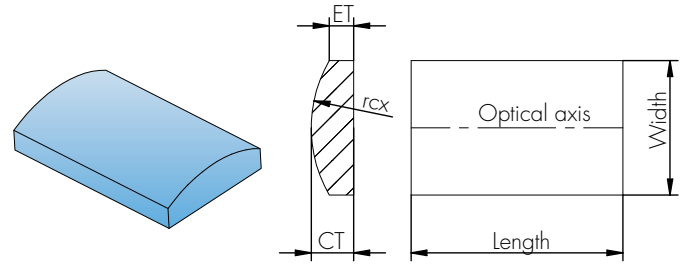

### Specifications:

- **Material:** BK7, fused silica
- **Diameter tolerance:**  
+ 0.00 mm; - 0.20 mm
- **Thickness tolerance:**  $\pm 0.20$  mm
- **Radii tolerance:**  
 $\pm 0.5\%$  for  $rcx < 0.5$  m  
 $\pm 1\%$  for  $0.5$  m  $< rcx < 2$  m  
*For radii larger than 2 m please check with our sales department.*
- **Clear aperture:** 85 % of diameter
- **Surface figure:**  
*Curved surface:*  
 $3/-(0.5/-)$  according to ISO 10110  
 $\lambda/4$  according to MIL-O-1380A  
*Plane surface:*  
 $3/0.2(0.2/-)$  according to ISO 10110  
 $\lambda/10$  according to MIL-O-1380A
- **Surface quality:**  
 $5/4 \times 0.025$  for 1.0" substrates according to ISO 10110  
 $10-5$  according to MIL-O-1380A
- **Centering error:**  
 $4/3'$  according to ISO 10110
- **Protective chamfer:**  
 $0.2 - 0.4$  mm  $\times 45^\circ$

### Cylindrical Lenses

#### Type

Rectangular plano convex cylindrical lens	RCX
Rectangular plano concave cylindrical lens	RCC
Round plano convex cylindrical lens	CLCX
Round plano concave cylindrical lens	CLCC

#### Nomenclature Cylindrical Lenses:

RCX (RCC)	40.0	- 25.4	- 25.4	C
Product code (Rectangular Plano Convex Cylindrical Lens)	Length in mm	Width in mm	Convex radius of curvature in mm	Material code UV: fused silica C: BK7
CLCX (CLCC)	- 25.4	- 25.4	C	
Product code (Circular Plano Convex Cylindrical Lens)	Width in mm	Convex radius of curvature in mm	Material code UV: fused silica C: BK7	

#### 👍 Good to know:

Similar to spherical lenses, cylindrical lenses can be produced that are polished on both sides and have different curvatures; intersecting cylindrical axes are also available upon request.

# PRISMS

Prisms are optical elements with planar surfaces that are not parallel to each other. There are two different types:

## **Reflection Prisms**

In reflection prisms, the effect of total reflection is used to deflect beams or rotate images. For this reason, the entrance and exit surfaces are generally AR coated.

## **Dispersion Prisms**

Dispersion prisms, however, are used to deflect light or separate light spectrally. Depending on the application, they are used with or without a coating.

## **Note**

When making an inquiry, simply specify the exact application and wavelength range in which the prism should be used.



#### Specifications:

- **Material:** BK7, fused silica, SF2
- **Dimension tolerance:**  
+ 0.0 mm; - 0.2 mm
- **Angle tolerance:**  $\pm 3'$ ;  $\pm 1'$ ;  $\pm 30''$
- **Surface figure:**  
3/0.25 according to ISO 10110  
 $\lambda/8$  according to MIL-01380A
- **Surface quality:**  
5/4 x 0.063 for 1.0" substrates  
according to ISO 10110  
20-10 according to MIL-01380A
- **Protective chamfer:**  
0.2 - 0.4 mm x 45°
- **Clear aperture:**  
85 % of the dimensions

#### Nomenclature Right Angle Prism

RAP	050	C
Product code (Right-Angle Prism)	Dimension A in inches x 100	Material code UV: fused silica C: BK7

#### Nomenclature Equilateral Dispersion Prism

EDP	-25.0	C
Product code (Equilater Dispersion Prism)	Dimension in mm	Material code C: BK7 SF: SF10

#### Nomenclature Solid Retroreflector

SRR	-12.7	-2	C
Product code (Solid Retroreflector)	Entrance diameter in mm	Beam deviation in Arc Seconds	Material code UV: fused silica C: BK7

#### Nomenclature Isocles Brewster Prism

IB	-12.4	-68.1	-UV
Product code (Isocles Brewster Prism)	Height h in mm	Apex angle in degree	Material code UV: fused silica SF: SF10

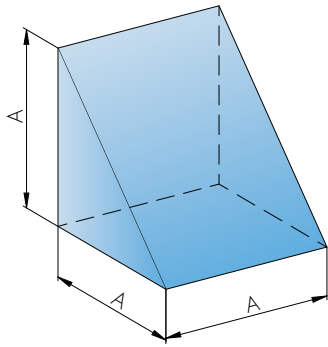

## RAP Series

### Right-Angled Prism

In rectangular prisms, the side surfaces are perpendicular to each other. Due to the total reflection, they can be used to deflect the beam with minimal losses for  $90^\circ$  or  $180^\circ$  deflections. For  $90^\circ$  deflections, the short side surfaces (catheti) generally feature an AR coating; for  $180^\circ$  deflections, the base surface (hypotenuse) general features an AR coating.

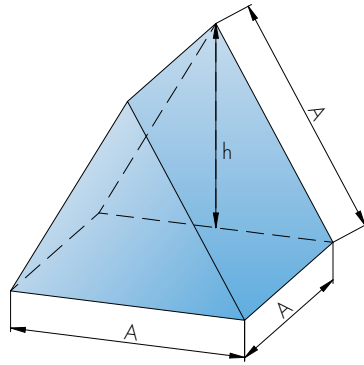

## EDP Series

### Equilateral Dispersion Prism

These equilateral prisms are used to divide the white light into the spectral colors or separate laser beams of different wavelengths from each other. Entrance and exit surfaces are commonly AR coated for this purpose.



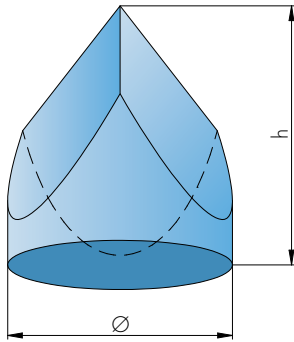

## SRR Series Retroreflector

The reflection of the incident beam occurs in so-called cat's eyes at three surfaces that are arranged perpendicular to each other. This allows beams to be deflected by  $180^\circ$ , irrespective of the angle of incidence. Thus, the exit beam always runs parallel to the entrance beam. For this reason, retroreflectors are commonly used for optical adjustments.

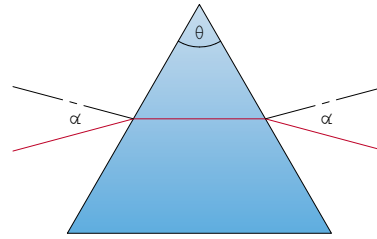

## IB Series Isosceles Brewster Prism

The isosceles Brewster prism is primarily used in beam deflection and compensation of the group velocity dispersion (GVD) in fs laser applications. The angle between the prism catheti is selected in such a way that the entrance beam and the exit beam form the Brewster angle.

This allows the light polarized parallel to the interface to be transmitted almost completely without loss and the perpendicularly polarized light to be largely reflected. An AR coating is, therefore, not necessary in these prisms.

### 👍 Good to know:

Three-dimensional materials are used in prisms made of fused silica.

These materials feature homogeneous refractive indices in the volume material.

# Product Codes

## Coatings

Product Code	Page
AR	060-061
BBAR	062-063
BS	048-051
DAR	062-063
GR	058-059
HR	042-043
HR HT	044-045
PR	046-047
TFPB	052-055
TFPK	056-057
U-AR	060-061
V-AR	060-061

## Substrates

Product Code	Page
BICC	072-075
BICX	072-075
CLCC	076-077
CLCX	076-077
EDP	078-081
IB	078-081
PI	068-071
PL	068-071
PLCC	072-075
PLCX	072-075

Product Code	Page
PP	068-071
PS	068-071
PU	068-071
PW	068-071
RAP	078-081
RCC	076-077
RCX	076-077
RI	068-071
RL	068-071
RS	068-071
RU	068-071
RW	068-071
SM	072-075
SMX	072-075

# INDEX

## A

AR Coatings (Antireflection) .....	060
Broadband AR Coatings (BBAR) ....	062
Multiple AR Coatings .....	062
U-AR / V-AR .....	060
Autocollimator .....	027

## B

BBAR-Coatings .....	062
Beam Splitters .....	048
Beamsplitter polarization independent .....	050
Bending Mirrors .....	042
Biconcave Lenses .....	075
Biconvex Lenses .....	075
Brewster Prisms .....	081
Broadband AR Coatings (BBAR) .....	062
Broadband Plate Polarizers .....	056

## C

Cleaning .....	033
Coating Designs .....	020
Coating Processes .....	010
Comparison of Coating Methods ..	022
E-Beam Coating .....	010
IAD Coating .....	012
Sputter Coating .....	014
Coatings .....	040
AR Coatings .....	060
Gaussian Mirrors .....	058
High Reflective Coatings .....	042
Polarizers .....	052

Curved Mirror Substrates .....	072
Spherical Concave Mirror Substrates .....	073
Spherical Convex Mirror Substrates .....	073
Cylindrical Lenses .....	076
Circular Plano-concave Cylindrical Lenses .....	077
Circular Plano-convex Cylindrical Lenses .....	077
Rectangular Plano-concave Cylindrical Lenses .....	077
Rectangular Plano-convex Cylindrical Lenses .....	077

## D

Development .....	036
Dichroic Mirrors .....	044
<i>(see Long-Pass/Short-Pass Mirror Coatings)</i>	
Dispersion Prisms .....	078
Double AR Coatings .....	062
Double Mirrors .....	043

## E

E-Beam Coating .....	010
End mirrors .....	046
Environmental Resistance .....	032
Equilateral Dispersion Prisms .....	080

## F

Fused Silica .....	066
--------------------	-----

## G

Gaussian Mirrors .....	058
------------------------	-----

## I

IAD Coating .....	012
IBS Coating .....	014
Interferometer .....	026
Isosceles Brewster Prisms .....	081

## L

Laser-Induces Damage Threshold .....	028
Layer Adhesion .....	032
Long-Pass/Short-Pass Mirror Coatings ..	044

## M

Measurement Technology .....	024
Mirror Blanks .....	070, 071, 072
Plane Mirror Blanks .....	070
Rectangular Mirror Blanks .....	070
Spherical Concave Mirror Substrates .....	072
Spherical Convex Mirror Substrates .....	072
Mirror Coatings .....	042
Long-pass/Short-pass Mirror Coatings .....	044
Multiple Mirrors .....	042
Partially Reflective Coatings .....	046
Multiple AR Coatings .....	062
Multiple Mirrors .....	042

## O

Online Broadband Monitoring .....	018
Output Couplers.....	046

## P

Packaging .....	033
Partially Reflective Coatings.....	046
Beam Splitters.....	048
Output Couplers.....	046
Plane Mirror Substrates.....	070
Plane Windows .....	070
Plane Parallel Windows.....	070
Plano-concave Lenses .....	073
Plano-concave Cylindrical Lenses.....	076
Plano-convex Lenses .....	074
Plano-convex Cylindrical Lenses.....	076
Plane Substrates .....	070
Mirror Substrates .....	070, 071
Rectangular/Square	
Plane Substrates .....	070
Round Plane Substrates .....	070
Wedge Substrates .....	070
Polarization Independent	
Beam Splitter.....	050
Polarizers, Thin Film Broadband .....	056
Polarizers, Thin Film Standard .....	052
Polarizers, Thin Film 45° .....	054
Polarizers, Thin Film Adjustmentfree .....	052

Prisms.....	078
Equilateral Dispersion Prisms .....	080
Isosceles Brewster Prisms .....	081
Rightangled Prisms .....	080

## Q

Quality Control .....	024
-----------------------	-----

## R

Rectangular Mirror Substrates.....	070
Rectangular Windows.....	070
Rightangled Prisms .....	080

## S

Short-Pass Mirror Coatings .....	046
Spherical Concave Mirror Substrates...	074
Spherical Convex Mirror Substrates.....	074
Sputter Coating.....	014
Standard Committee.....	038
Substrates .....	064
Curved Mirror Substrates.....	072
Plane Substrates .....	070
Prisms.....	078
Surface Imperfections .....	030

## T

Technology.....	016
Thin Film Polarizers.....	052
Thin Film Polarizers, Standard .....	052
Thin Film Polarizers 45° .....	054
Thin Film Polarizers, Broadband .....	056

## U

U-AR .....	060
------------	-----

## V

V-AR.....	060
VRM Mirrors .....	058

## W

Wedge Substrates .....	070
White-Light Interferometer .....	027
Windows.....	070
Plane Windows .....	070
Plane Parallel Windows.....	070
Rectangular/Square Windows.....	070
Wedge Windows .....	070



# IMPRINT



## Editor

---

LASER COMPONENTS GmbH  
Werner-von-Siemens-Str. 15  
82140 Olching/Germany

Tel: +49 8142 2864-0

Fax: +49 8142 2864-11

[www.lasercomponents.com](http://www.lasercomponents.com)

[info@lasercomponents.com](mailto:info@lasercomponents.com)

General Managers: Patrick Paul  
Commercial Register in Munich HRB 77055

Print: flyeralarm, Würzburg



## Copyright

---

This catalog, including all written and visual entries, is protected by copyright. With the exception of specific cases permitted by law, use of this material without the consent of Laser Components GmbH is punishable by law.

Despite thorough research, Laser Components GmbH will not accept responsibility for any inaccuracy of content. Technical material is subject to change without notice.

Worldmap on backcover: © [istock.com/dikobraziy](https://www.istock.com/dikobraziy)

© 2018. All rights reserved.

V6; 01/18 3033744

Notes on the trademark ownership

HPFS® is a registered trademark of Corning, Inc.

Infrasil® and Suprasil® are registered trademarks of

Heraeus Quarzglas GmbH & Co. KG.



## Contact

### Germany & Worldwide Contact LASER COMPONENTS GmbH

Werner-von-Siemens-Str. 15  
82140 Olching / Germany

Tel.: +49 8142 28640  
info@lasercomponents.com  
[www.lasercomponents.com](http://www.lasercomponents.com)

### France LASER COMPONENTS S.A.S.

45 Bis Route des Gardes  
92190 Meudon / France

Tel.: +33 1 3959 5225  
info@lasercomponents.fr  
[www.lasercomponents.fr](http://www.lasercomponents.fr)

### Nordic Countries LASER COMPONENTS Nordic AB

Skårs led 3  
41263 Göteborg / Sweden

Tel.: +46 31 703 71 73  
info@lasercomponents.se  
[www.lasercomponents.se](http://www.lasercomponents.se)

### USA LASER COMPONENTS USA, Inc.

116 South River Road  
Bedford, NH 03110 / USA

Tel: +1 603 821 7040  
info@laser-components.com  
[www.lasercomponents.com](http://www.lasercomponents.com)

### Great Britain LASER COMPONENTS (UK) Ltd.

Goldlay House 114 Parkway  
Chelmsford Essex CM2 7PR / UK

Tel: +44 1245 491 499  
info@lasercomponents.co.uk  
[www.lasercomponents.co.uk](http://www.lasercomponents.co.uk)

