

ModBox-OBand-NRZ series

O-Band, 28 Gb/s, 44 Gb/s, 50 Gb/s Reference Transmitters

MODBOX

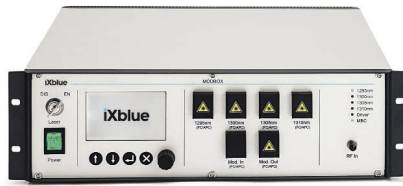

The ModBox-OBand-NRZ series is a family of Reference Transmitters that generate excellent quality NRZ optical data streams up to 28 Gb/s, 44 Gb/s, 50 Gb/s in the O-band. These transmitters produce very clean eye diagrams with high SNR and short rise and fall times. They also provide the flexibility of adjusting the extinction ratio for vertical eye closure.

The ModBox-OBand-NRZ series provides R&D and Production engineers with a user friendly turn-key instrument delivering state of the art performance. It is being used in optical telecommunications laboratories and production test beds.

The equipment incorporates a modulation stage based on a chirp-free LiNb₃ Mach-Zehnder modulator, coupled with a high performance RF driver and an automatic bias control circuitry. It also integrates a DFB laser source and an optional photo-detector.

In addition to the O-band, iXblue offers reference transmitters in the C-band, 1 μm region and at 850 nm.

FEATURES

- Full O-Band Reference Transmitter
- Up to 28 Gb/s, 44 Gb/s, 50 Gb/s
- Reliable & reproducible measurements
- High eye diagram stability
- Extinction Ratio Adjustable

APPLICATIONS

- Transmission system test
- Components characterization
- Production test
- R&D laboratories

OPTIONS

- 5 nm and 20 nm spacing lasers
- Variable Extinction Ratio
- Receiver stage
- Multi-Channel
- 850 nm, 1310 nm & 1550 nm, C-band

Performance Highlights

Parameter	Min	Typ	Max
Operating wavelength	1270 nm	1310 nm	1330 nm
Modulation format	NRZ		
Modulation bandwidth	28 Gb/s, 44 Gb/s, 50 Gb/s		
Modulated output power (option HP)	6 dBm	-	-

ModBox-OBand-NRZ series

O-Band, 28 Gb/s, 44 Gb/s, 50 Gb/s Reference Transmitters

MODBox

Functional Block Diagram

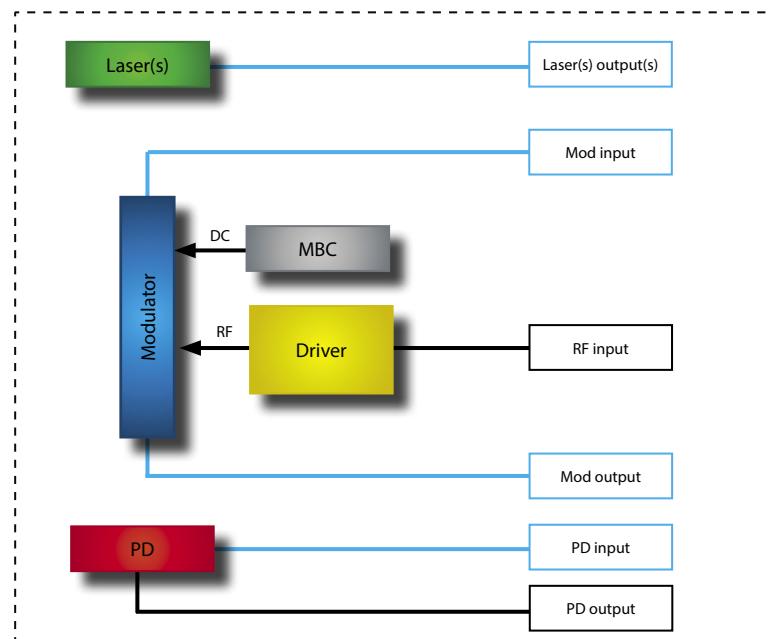

The ModBox-OBand-NRZ series feature:

- A chirp-free X-cut LiNbO_3 (Lithium Niobate) Mach-Zehnder Intensity modulator. It is selected for its high electro-optic bandwidth and flat, low ripple, electro-optic response curve.
- A high bandwidth limiting RF driver with gain and crossing levels adjustment for eye diagram optimization.
- A modulator bias controller. The internal LiNbO_3 modulator is a X-cut device with very low drift. However an automatic bias control circuit is provided to lock the operating point of the modulator at the quadrature point whatever the environmental conditions. The MBC ensures a highly stable optical output signal to provide reliable and reproducible measurements.
- A 1310 nm low RIN laser is integrated by default. For convenience, an external patch cord is delivered to connect the laser output to the optical input of the modulation stage. Wavelength and power are tunable through the front panel controls or the ModBox software interface.

The ModBox-OBand-NRZ is controlled from the front panel via the Smart interface with a simple rotary knob and keypad. The Smart manual interface allows for bias control circuit, driver gain and laser settings. It comes also with a simple GUI solution, Windows based and implemented through the USB interface of the user PC.

ModBox-OBand-NRZ series

O-Band, 28 Gb/s, 44 Gb/s, 50 Gb/s Reference Transmitters

MODBOX

Input Electrical Specifications User supplied, not a ModBox specification

Parameter	Symbol	Condition	Min	Typ	Max	Unit	
Data-rate	PRBS	ModBox-OBand-NRZ-28Gb/s	0.1	-	28	Gb/s	
		ModBox-OBand-NRZ-44Gb/s	0.1	-	44	Gb/s	
		ModBox-OBand-NRZ-50Gb/s	0.1	-	50	Gb/s	
Input voltage	V _{IN}	AC coupled - 50 Ω - Single ended	0.400	0.450	0.500	V _{pp}	
Jitter	J _{RMS}	-	-	1	1.2	ps	
Rise / fall time	t _r / t _f	20 % - 80 %	28Gb/s	-	13	18	ps
			44 Gb/s	-	8	10	ps
			50 Gb/s	-	7	8	ps

Input Optical Specifications User supplied, not a ModBox specification

Parameter	Symbol	Condition	Min	Typ	Max	Unit
Operation	λ	CW	1270	-	1330	nm
Polarization	-	-	Linear and controlled			-
Power	P	-	-	-	40	mW
Side Mode Supression Ratio	SMSR	-	30	-	-	dB
Spectrum linewidth	Δλ	FWHM	-	1	-	MHz
Relative Intensity Noise	RIN	0.2 GHz - 3 GHz	-	-150	-	dB/Hz

Output Optical Specifications Specifications below are given with embedded 1310 nm laser.

Parameter	Symbol	Condition	Min	Typ	Max	Unit
Data-rate	PRBS	ModBox-OBand-28Gb/s-NRZ	0.1	-	28	Gb/s
		ModBox-OBand-44Gb/s-NRZ	0.1	-	44	Gb/s
		ModBox-OBand-50Gb/s-NRZ	0.1	-	50	Gb/s
Added RMS jitter	J _{RMS}	$\sqrt{J_{RMS}^2 = J_{RMS-total}^2 - J_{RMS-source}^2}$	-	0.8	1.2	ps
Dynamic Extinction Ratio	DER	-	-	12	18	dB
Dynamic Signal to Noise Ratio	SNR	-	15	20	-	-
Rise / fall time	t _r / t _f	ModBox-OBand-28Gb/s-NRZ	-	10	12	ps
		ModBox-OBand-44Gb/s-NRZ	-	8	10	ps
		ModBox-OBand-50Gb/s-NRZ	-	-	8	ps
Cross point	-	-	45	50	55	%
Eye cross point variation	-	-	-5	-	5	%
Electrical Return loss	ERL	-	-	-10	-	dB
Average output power	P _{out}	With embedded 1310 nm laser	2	3	-	dBm
		High output power option @1310 nm	6	7	-	dBm
		Other CWDM, LAN-WDM lasers	2	3	-	dBm

ModBox-OBand-NRZ series

O-Band, 28 Gb/s, 44 Gb/s, 50 Gb/s Reference Transmitters

MODBox

1310 nm DFB Laser Specifications and Other Lasers Option The laser 1310 nm laser is embedded by default.

Parameter	Symbol	Condition	Min	Typ	Max	Unit
Laser type	-	-	DFB			-
Wavelength	λ	Embedded by default	-	1310	-	nm
Additional wavelengths	λ	5 nm spacing (option)	1295 nm, 1300 nm, 1305 nm			-
		20 nm spacing (option)	1270 nm, 1290 nm, 1330 nm			-
Wavelength laser tuning range	-	Diode chip temperature control	-	0.8	1	nm
Optical output power	-	CW	20	-	-	mW
Optical output power adjustment	-	Diode Injection current control	0	-	100	%
Spectrum linewidth	$\Delta\lambda$	FWHM	-	2	-	MHz
Side Mode Suppression Ratio	SMSR	-	35	-	-	dB
Optical Return Loss	ORL	-	30	-	-	dB

Variable Extinction Ratio Specifications Option

Parameter	Symbol	Condition	Min	Typ	Max	Unit
Data-rate	PRBS	ModBox-OBand-28Gb/s-NRZ	0.1	-	28	Gb/s
Variable Extinction Ratio	VER	-	3	-	12	dB
Pre-set VER values	VER	Available from Smart and GUI	3 dB, 6 dB, 9 dB, 12 dB			-

Optical Photodiode Specifications

Parameter	Symbol	Condition	Min	Typ	Max	Unit
Detector type	-	Single ended	PIN			-
Operating wavelength range	λ	-	1300	-	1620	nm
Data-rate	-	-	45	50	-	Gb/s
Average optical input power	P_{IN}	CW or NRZ	-	-	10	dBm
DC responsivity	R	@1310 nm	-	0.45	-	A/W
		@1550 nm	-	0.65	-	A/W
Optical Return Loss	ORL	@1310 nm	24	-	-	dB
		@1550 nm	27	-	-	dB

Absolute Maximum Ratings

Stresses in excess of the absolute maximum ratings can cause permanent damage to the device. These are absolute stress ratings only. Functional operation of the device is not implied at these or any other conditions in excess of those given in the operational sections of the data sheet. Exposure to absolute maximum ratings for extended periods can adversely affect device reliability.

Parameter	Symbol	Min	Max	Unit
Input voltage	V_{IN}	-	1	V _{pp}
Optical input power	OP_{IN}	-	20	dBm

ModBox-OBand-NRZ series

O-Band, 28 Gb/s, 44 Gb/s, 50 Gb/s Reference Transmitters

ModBox

Eye Diagrams - 28 Gb/s - 1310 nm - From ModBox-OBand-28Gb/s-NRZ

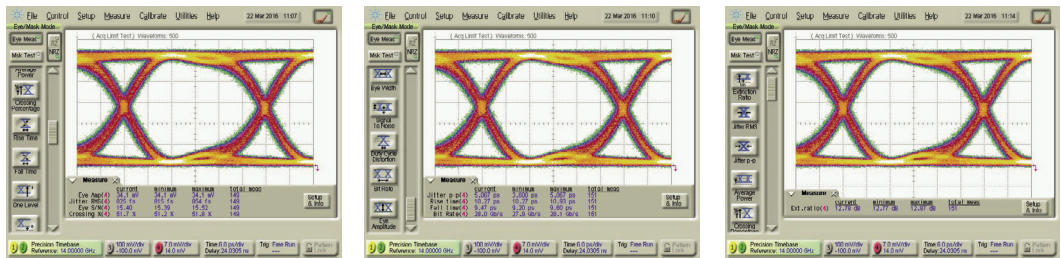

Eye Diagrams - 28 Gb/s - 1310 nm with Variable ER option - From ModBox-OBand-28Gb/s-NRZ with VER option

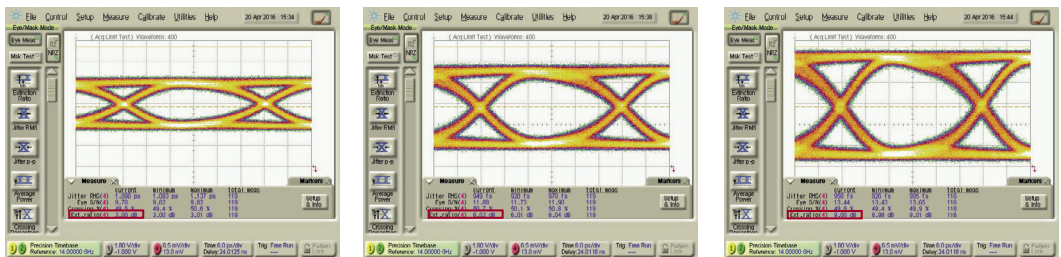

Eye Diagrams - 44 Gb/s - 1310 nm - From ModBox-OBand-44Gb/s-NRZ

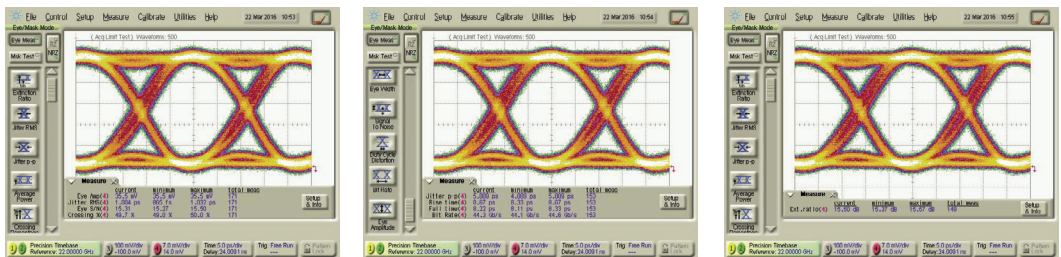

Eye Diagrams - 50 Gb/s - 1310 nm - From ModBox-OBand-50Gb/s-NRZ

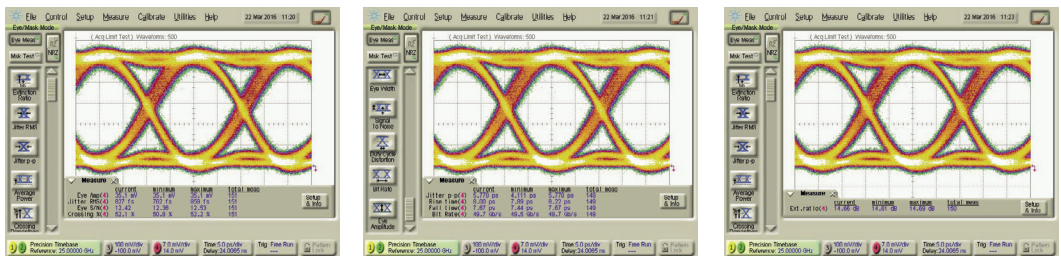

ModBox-OBand-NRZ series

O-Band, 28 Gb/s, 44 Gb/s, 50 Gb/s Reference Transmitters

MODBOX

Interfaces, Dimensions and Compliance

Interfaces	
Optical	Polarization maintaining fiber PM1300 - FC/APC (by default, other connectors type in option)
RF input	Single 1.85 mm female RF connector - 50 Ω
Control	Smart Interface (front panel), GUI (USB typeB)
Power supply	100-120V/220-240 automatic switch 50-60Hz (Rear panel)
EMC and optical norms	EN61326-1 Ed. 2006 / NF EN 60825-1 & EN 60825-2 Ed.2014
Dimensions / Weight	Rack 19" x 3U, Depth=375mm / 3 kg

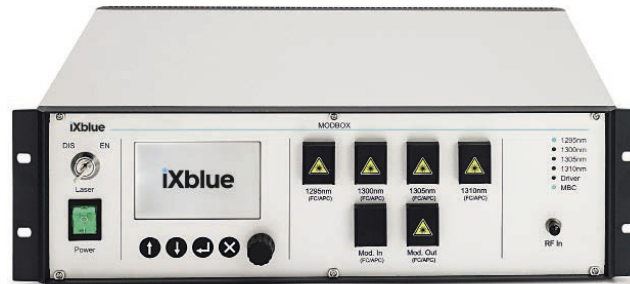

4 lanes Laser ModBox - NRZ example - Front panel

Ordering information

ModBox-OBand-XXGbps-NRZ

OBand = Full band of operation, embeds laser, 1310 nm by default
 XX = Data-rate: 28Gb/s up to 28 Gb/s - 44 Gb/s up to 44 Gb/s - 50 Gb/s up to 50 Gb/s

Opt-DFB-YY

DFB laser option:
 XX = Optional additional laser - Wavelength in nm

Opt-VER

Variable Extinction Ratio option. Only available up to 28 Gb/s

Opt-YY

YY = Output connectors, FA : FC/APC - FC : FC/UPC - SA : SC/APC - SC : SC/UPC

About us

iXBlue Photonics produces specialty optical fibers and Bragg gratings based fiber optics components and provides optical modulation solutions based on the company lithium niobate (LiNbO₃) modulators and RF electronic modules.

iXBlue Photonics serves a wide range of industries: sensing and instruments, defense, telecommunications, space and fiber lasers as well as research laboratories all over the world.

iXblue reserves the right to change, at any time and without notice, the specifications, design, function or form of its products described herein. All statements, specification, technical information related to the products herein are given in good faith and based upon information believed to be reliable and accurate at the moment of printing. However the accuracy and completeness thereof is not guaranteed. No liability is assumed for any inaccuracies and as a result of use of the products. The user must validate all parameters for each application before use and he assumes all risks in connection with the use of the products