

MODULATOR

NIR-MX800-LN series

800 nm band 10 & 20 GHz Intensity Modulators

The NIR-MX800-LN series are 10 GHz and 20 GHz intensity modulators especially designed for operation in the 800 nm wavelength band.

NIR-MX800 Mach-Zehnder modulators offer engineers working in the 800 nm band the intrinsic and unparalleled benefits of LiNbO₃ modulation: high bandwidth, high contrast and ease of use.

NIR-MX800 series Intensity Modulators use proton exchange waveguide process on a doped LiNbO₃ substrat. This unique combination confers them an unparalleled stability and a superior optical power handling.



Features

- High Bandwidth
- X-cut for high stability
- High optical power handling
- Low drive voltage
- Low insertion loss

Applications

- Quantum optics
- 850 nm 100 GbE testing
- Pulse generation / picking

Options

- High extinction ratio > 30 dB
- Lower insertion loss
- 950 nm band modulators versions

Related Equipments

- RF amplifiers
- MBC Automatic Bias Controllers
- NIR-MPX800 Phase Modulators
- Modbox 850 nm 28 Gb/s NRZ

NIR-MX800-LN-10 Performance Highlights

Parameter	Min	Typ	Max	Unit
Operating wavelength	780	-	850	nm
Insertion loss	-	4.5	-	dB
Optical input power	-	-	14	dBm
Electro-optical bandwidth	-	12	-	GHz
V _π RF @50 kHz	-	3.5	-	V
Electrical return loss	-	12	-	dB

Specifications given at 25 °C, 780 nm or 850 nm

NIR-MX800-LN-20 Performance Highlights

Parameter	Min	Typ	Max	Unit
Operating wavelength	780	-	850	nm
Insertion loss	-	4.5	-	dB
Optical input power	-	-	14	dBm
Electro-optical bandwidth	-	25	-	GHz
V _π RF @50 kHz	-	3.5	-	V
Electrical return loss	-	12	-	dB

Specifications given at 25 °C, 780 nm or 850 nm



MODULATOR | NIR-MX800-LN SERIES | 2/5

NIR-MX800-LN-10

10 GHz Intensity Modulator

Electrical Characteristics

Parameter	Symbol	Condition	Min	Typ	Max	Unit
Electro-optical bandwidth	S_{21}	RF electrodes, from 2 GHz	10	12	-	GHz
Ripple S_{21}	ΔS_{21}	RF electrodes, $f < 10$ GHz	-	0.5	1	dB
Electrical return loss	S_{11}	RF electrodes	-	-12	-10	dB
V_{π} RF @50 kHz	$V_{\pi_{RF\ 50\ kHz}}$	RF electrodes	-	3.5	4.5	V
V_{π} DC electrodes	$V_{\pi_{DC}}$	DC electrodes	-	3.9	4.5	V
Impedance matching	Z_{in-RF}	-	-	50	-	Ω
DC input impedance	Z_{in-DC}	-	-	1	-	M Ω

Optical Characteristics

Parameter	Symbol	Condition	Min	Typ	Max	Unit
Crystal	-	-	Lithium Niobate X-Cut Y-Prop			
Operating wavelength	λ	-	780	800	850	nm
Insertion loss	IL	Without connectors*	-	4.5	5.5	dB
DC extinction ratio	ER	Measured with narrow source linewidth < 200 MHz	20	22	-	dB
Optical return loss	ORL	-	-40	-45	-	dB
Chirp	α	-	-0.1	0	0.1	-

All specifications given at 25 °C, 780 nm or 850 nm

*1 Consider an extra-loss up to 0.6 dB for each FC/APC optical connector

Absolute Maximum Ratings

Stresses in excess of the absolute maximum ratings can cause permanent damage to the device. These are absolute stress ratings only. Functional operation of the device is not implied at these or any other conditions in excess of those given in the operational sections of the data sheet. Exposure to absolute maximum ratings for extended periods can adversely affect device reliability.

Parameter	Symbol	Min	Max	Unit
RF input power	EP_{in}	-	28	dBm
Bias Voltage	V_{bias}	-20	+20	V
Optical input power	OP_{in}	-	14	dBm
Operating temperature	OT	0	+70	°C
Storage temperature	ST	-40	+85	°C



MODULATOR | NIR-MX800-LN SERIES | 3/5

NIR-MX800-LN-20

20 GHz Intensity Modulator

Electrical Characteristics

Parameter	Symbol	Condition	Min	Typ	Max	Unit
Electro-optical bandwidth	S_{21}	RF electrodes, from 2 GHz	20	25	-	GHz
Ripple S_{21}	ΔS_{21}	RF electrodes, $f < 20$ GHz	-	0.5	1	dB
Electrical return loss	S_{11}	RF electrodes, $f < 20$ GHz	-	-13	-10	dB
V_{π} RF @50 kHz	$V_{\pi_{RF\ 50\ kHz}}$	RF electrodes	-	3.5	4.5	V
V_{π} DC electrodes	$V_{\pi_{DC}}$	DC electrodes	-	3.9	4.5	V
Impedance matching	Z_{in-RF}	-	-	50	-	Ω
DC input impedance	Z_{in-DC}	-	-	1	-	M Ω

Optical Characteristics

Parameter	Symbol	Condition	Min	Typ	Max	Unit
Crystal	-	-	Lithium Niobate X-Cut Y-Prop			
Operating wavelength	λ	-	780	800	850	nm
Insertion loss	IL	Without connectors*	-	4.5	5.5	dB
DC extinction ratio	ER	Measured with narrow source linewidth < 200 MHz	20	22	-	dB
Optical return loss	ORL	-	-40	-45	-	dB
Chirp	α	-	-0.1	0	0.1	-

All specifications given at 25 °C, 780 nm or 850 nm

*1 Consider an extra-loss up to 0.6 dB for each FC/APC optical connector

Absolute Maximum Ratings

Stresses in excess of the absolute maximum ratings can cause permanent damage to the device. These are absolute stress ratings only. Functional operation of the device is not implied at these or any other conditions in excess of those given in the operational sections of the data sheet. Exposure to absolute maximum ratings for extended periods can adversely affect device reliability.

Parameter	Symbol	Min	Max	Unit
RF input power	EP_{in}	-	28	dBm
Bias Voltage	V_{bias}	-20	+20	V
Optical input power	OP_{in}	-	14	dBm
Operating temperature	OT	0	+70	°C
Storage temperature	ST	-40	+85	°C



MODULATOR | NIR-MX800-LN SERIES | 4/5
NIR-MX800-LN-10 & 20

NIR-MX800-LN-10 Typical S_{21} Curve

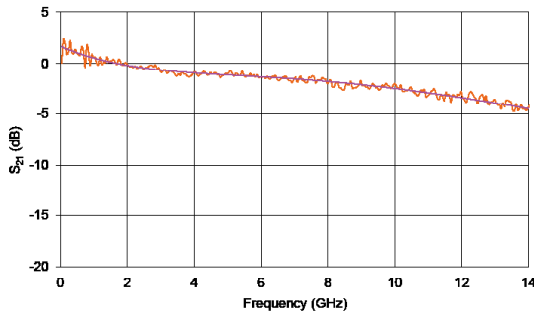

NIR-MX800-LN-10 Typical S_{11} Curve

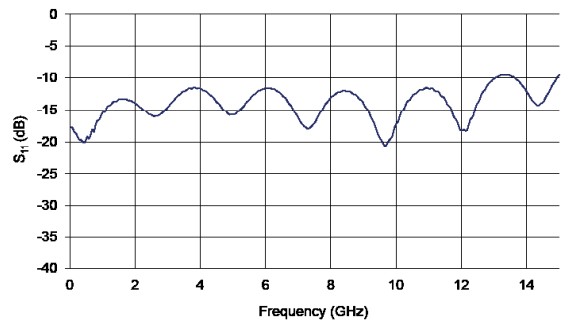

NIR-MX800-LN-20 Typical S_{21} Curve

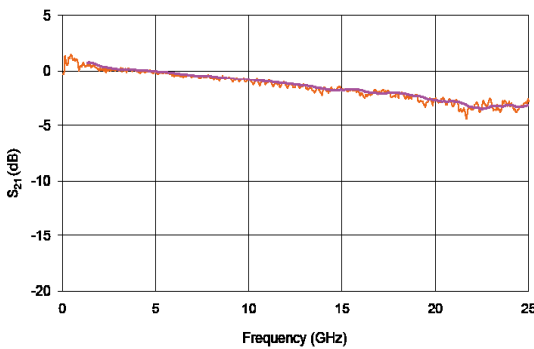

NIR-MX800-LN-20 Typical S_{11} Curve

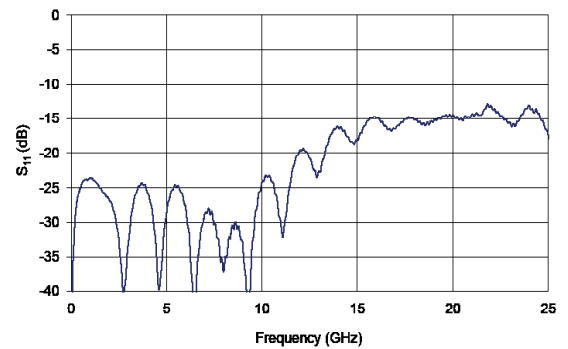

NIR-MX800-LN-20: 30 ps Square Pulse

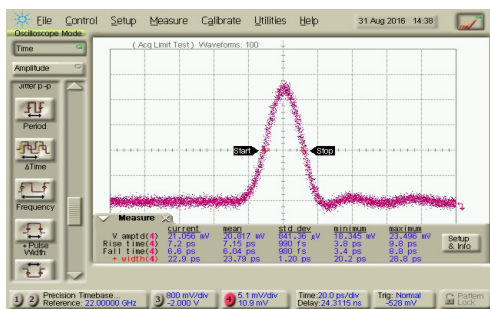

Stability with Time and Temperature

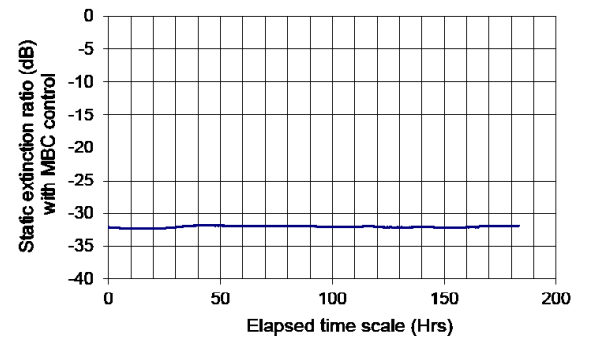

exail

MODULATOR | NIR-MX800-LN SERIES | 5/5

Mechanical Diagram and Pinout

All measurements in mm

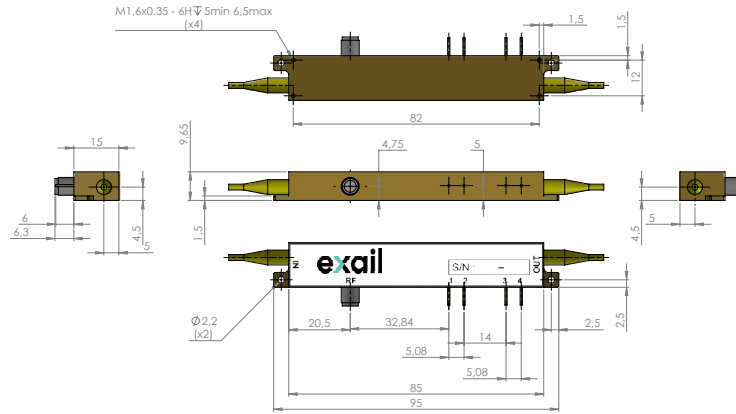

Port	Function	Note
IN	Optical input port	Polarization maintaining fiber Corning PM 85-U25D Length: 1.5 meter, buffer diameter: 900 μ m
OUT	Optical output port	Polarization maintaining fiber Corning PM 85-U25D Length: 1.5 meter, buffer diameter: 900 μ m
RF	RF input port	Female K
1	Ground	Pin feed through diameter 1.0 mm
2	DC	Pin feed through diameter 1.0 mm
3, 4	Photodiode cathode, anode	Pin feed through diameter 1.0 mm

Ordering information

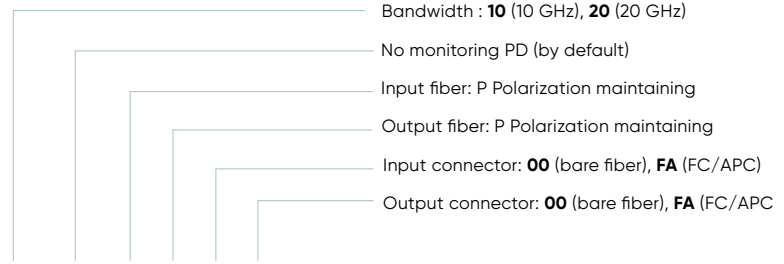

NIR-MX800-LN-□-00-□-□-□-□ Note: optical connectors are Senko with narrow key or equivalent

About us

Exail Photonics produces specialty optical fibers and Bragg gratings based fiber optics components and provides optical modulation solutions based on the company lithium niobate (LiNbO₃) modulators and RF electronic modules.

Exail Photonics serves a wide range of industries: sensing and instruments, defense, telecommunications, space and fiber lasers as well as research laboratories all over the world.

Exail reserves the right to change, at any time and without notice, the specifications, design, function or form of its products described herein. All statements, specification, technical information related to the products herein are given in good faith and based upon information believed to be reliable and accurate at the moment of printing. **However, Exail provides no warranty (whether express or implied or statutory) as to the description, sufficiency, accuracy or completeness, merchantability or fitness for a particular purpose of any information or specification detailed herein.** No liability is assumed for any inaccuracies and/or as a result of use of the products. The user must validate all parameters for each application before any use and he **shall** assume all risks **and responsibilities** in connection with the use of the products.



01_2023_ED5 / 00023424-A / 00023441-A