

SQF-Series Pulsed Laser Diodes with Homogenized Beam

Features

- Homogenized beam
- 905 nm
- Excellent temperature stability
- Proven InGaAs / GaAs high reliability structure
- Custom versions available
- Hermetic and custom designed package

Applications

- Range finding
- Surveying equipment
- Laser radar
- Medical
- "Friend or foe" identification
- Security barrier
- Weapon simulation



Germany & Other Countries

Laser Components Germany GmbH
Tel: +49 8142 2864 - 0
Fax: +49 8142 2864 - 11
info@lasercomponents.com
www.lasercomponents.com

France

Laser Components S.A.S.
Tel: +33 1 39 59 52 25
Fax: +33 1 39 59 53 50
info@lasercomponents.fr
www.lasercomponents.fr

United Kingdom

Laser Components (UK) Ltd.
Tel: +44 1245 491 499
Fax: +44 1245 491 801
info@lasercomponents.co.uk
www.lasercomponents.co.uk

Nordic Countries

Laser Components Nordic AB
Tel: +46 31 703 71 73
Fax: +46 31 703 71 01
info@lasercomponents.se
www.lasercomponents.se

USA

Laser Components USA, Inc.
Tel: +1 603 821 - 7040
Fax: +1 603 821 - 7041
info@lasercomponents.com
www.lasercomponents.com

905 xx SQF-Series

Generic Characteristics at $t_{RT} = 21^{\circ}\text{C}$ and I_{FM}

	Min	Typ	Max	Units
Wavelength of peak radiant intensity λ	895	905	915	nm
Spectral bandwidth $\Delta\lambda$ at 50% intensity points		5		nm
Wavelength temperature coefficient		0.28		nm/ $^{\circ}\text{C}$

Multi Junction Chip

Single chip characteristics at $t_{RT} = 21^{\circ}\text{C}$, $t_W = 150\text{ ns}$, $P_{rr} = 6.66\text{ kHz}$

Parameter	905D1S3JT06-SQF-14-15
Integrated pulsed laser diode	905D1S3JT06R
P_o ex fiber at i_{FM} (typ.)	30 W
Emitting area	140 x 140 μm^2
Divergence NA	0.27
Max peak forward current i_{FM}	22 A
I_{th} typ	600 mA
Forward voltage at I_{max}	11.8 V

Germany & Other Countries

Laser Components Germany GmbH
Tel: +49 8142 2864 - 0
Fax: +49 8142 2864 - 11
info@lasercomponents.com
www.lasercomponents.com

France

Laser Components S.A.S.
Tel: +33 1 39 59 52 25
Fax: +33 1 39 59 53 50
info@lasercomponents.fr
www.lasercomponents.fr

United Kingdom

Laser Components (UK) Ltd.
Tel: +44 1245 491 499
Fax: +44 1245 491 801
info@lasercomponents.co.uk
www.lasercomponents.co.uk

Nordic Countries

Laser Components Nordic AB
Tel: +46 31 703 71 73
Fax: +46 31 703 71 01
info@lasercomponents.se
www.lasercomponents.se

USA

Laser Components USA, Inc.
Tel: +1 603 821 - 7040
Fax: +1 603 821 - 7041
info@laser-components.com
www.laser-components.com

Figure 1: Typ. near field emission (2 D view)

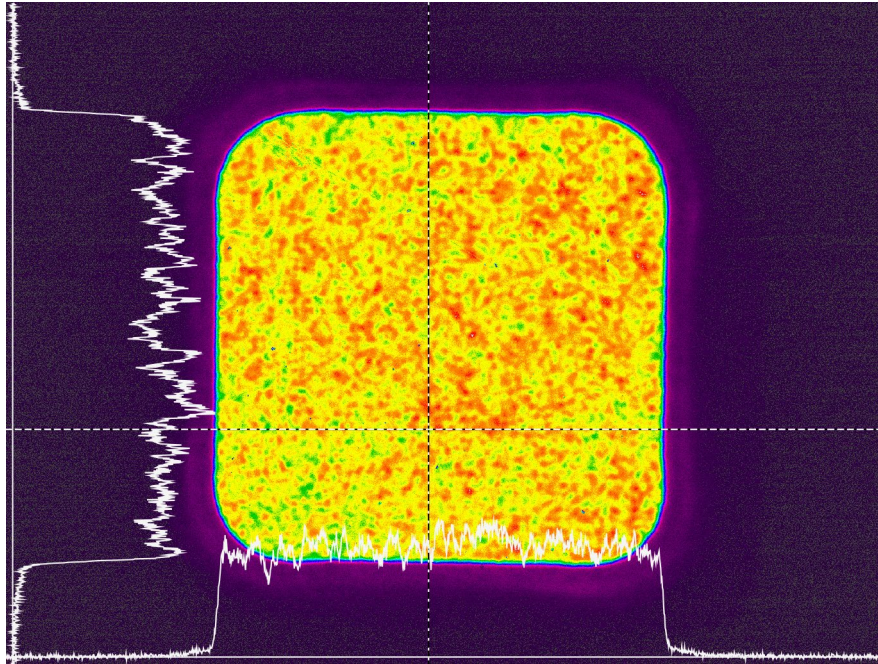
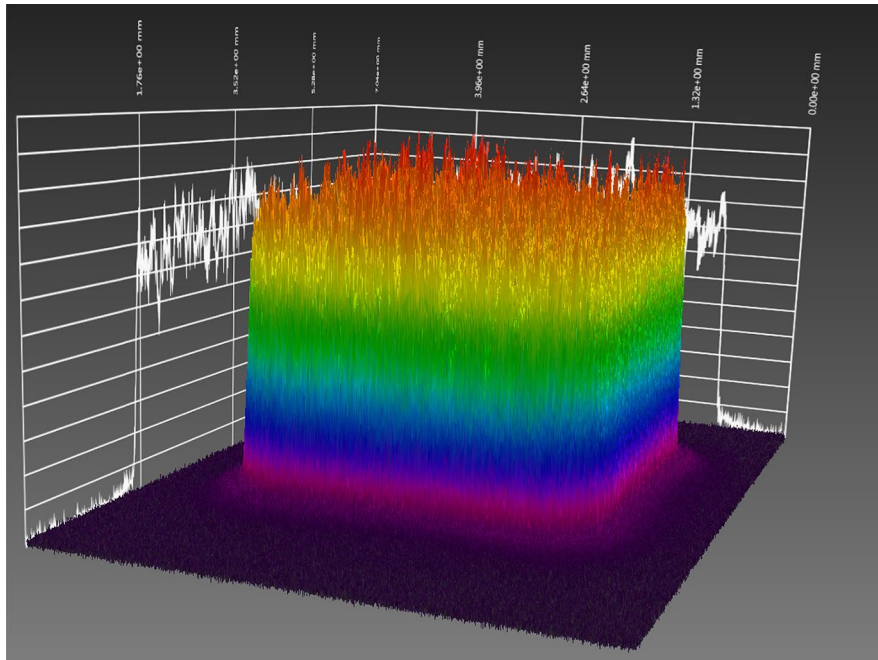

Figure 2: Typ. near field emission uniformity (3D view)



Absolute Maximum Ratings

Maximum ratings	Limiting values
Peak reverse voltage	36 V
Pulse duration Single element	150 ns
Duty factor	0.1%
Temperature Storage Operating	-55 °C to +85 °C -40 °C to +85 °C
Lead soldering 5 seconds max at	200 °C

Note: Further specifications are available on the individual datasheets of the integrated pulsed laser diode.

Product Number Designation

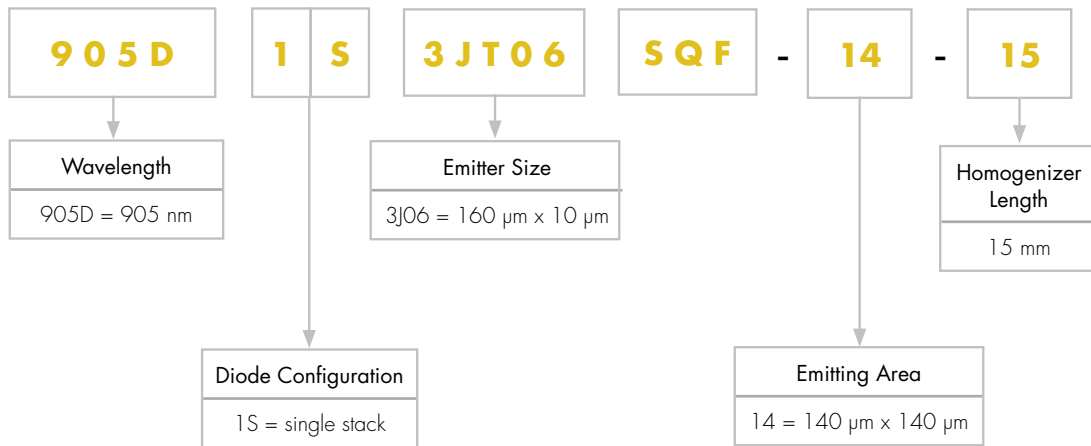

Note: other configurations are available upon request.
Please contact us for further details.

Package SQF-Series

15 mm homogenizer

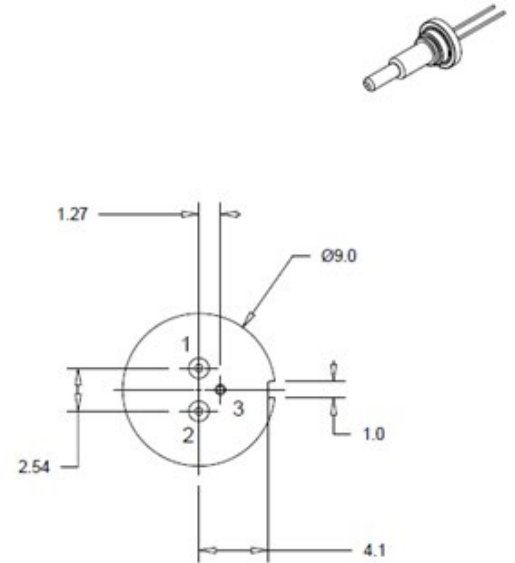
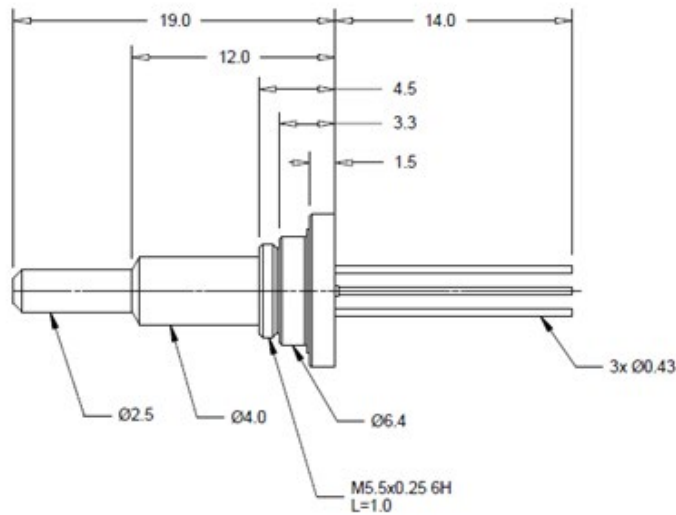

Pin Out:

- 1- LD Anode (+),
- 2- NC,
- 3- LD Cathode (-) Case.

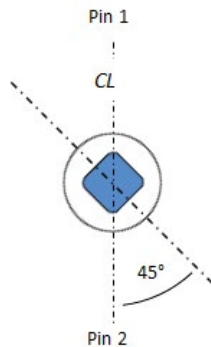

Core orientation with respect to case

Product Changes

LASER COMPONENTS reserves the right to make changes to the product(s) or information contained herein without notice. No liability is assumed as a result of their use or application.

Ordering Information

Products can be ordered directly from LASER COMPONENTS or its representatives. For a complete listing of representatives, visit our website at www.lasercomponents.com

Custom designed products are available on request.

Laser Safety

Personal Hazard:

Depending on the mode of operation, these devices emit highly concentrated non visible infrared light which can be hazardous to the human eye. Products which incorporate these devices have to follow the safety precautions given in IEC 60825-1 "Safety of laser products".

Handling Precautions:

Products are subject to the risks normally associated with sensitive electronic devices including static discharge, transients, and overload.

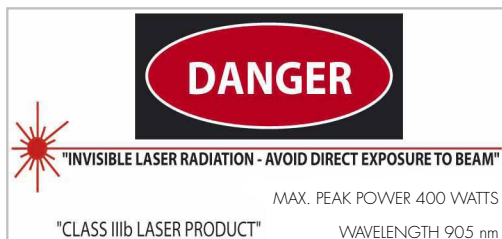

Germany & Other Countries

Laser Components Germany GmbH
Tel: +49 8142 2864 - 0
Fax: +49 8142 2864 - 11
info@lasercomponents.com
www.lasercomponents.com

France

Laser Components S.A.S.
Tel: +33 1 39 59 52 25
Fax: +33 1 39 59 53 50
info@lasercomponents.fr
www.lasercomponents.fr

United Kingdom

Laser Components (UK) Ltd.
Tel: +44 1245 491 499
Fax: +44 1245 491 801
info@lasercomponents.co.uk
www.lasercomponents.co.uk

Nordic Countries

Laser Components Nordic AB
Tel: +46 31 703 71 73
Fax: +46 31 703 71 01
info@lasercomponents.se
www.lasercomponents.se

USA

Laser Components USA, Inc.
Tel: +1 603 821 - 7040
Fax: +1 603 821 - 7041
info@laser-components.com
www.laser-components.com