

High Linearity Position Sensing Detector

Part Number: S2-0001

Description: 2L2_MP1

The SiTek 2L2 PSD functions according to the Lateral Effect Photodiode principle. It is an analogue device and therefore displays excellent position resolution. The resolution is determined by the system signal-to-noise ratio.

The 2L2 is operated in the biased mode. Typical applications include: distance and height measurement, alignment, position and motion measurements and vibration studies.

Special UV- or YAG-enhanced and Nuclear versions are available.

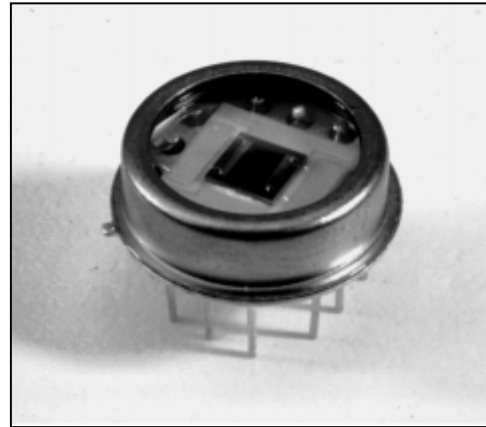

Parameter	Symbol	Min.	Typ.	Max.	Unit
Active area			2 x 2		mm ²
Position non-linearity			0,3	1,0	%(±)
Detector resistance	R _{det}	7	10	16	k Ω
Dark current	I _d		50	200	nA
Noise current	I _{noise}		1,3	2,5	pA/√Hz
Responsivity	r		0,58		A/W
Capacitance	C _j		7	8	pF
Rise time (10-90%)	t _r		30	60	ns
Reverse voltage (bias)	V _r	5	15	20	V
Thermal drift			40	200	ppm/°C
Maximum ratings					
Reverse voltage	V _{R-max}			30	V
Operating temperature	T _{oper}			70	°C
Storage temperature	T _{stg}			100	°C

Test conditions: Room temperature 23°C. Reverse voltage 15 V. Light-source wavelength 940 nm.
Position non-linearity and thermal drift are valid within 80% of the detector length.

Package: 12-pin TO-8 metal housing, 15,3 mm diameter, with protective sapphire window.

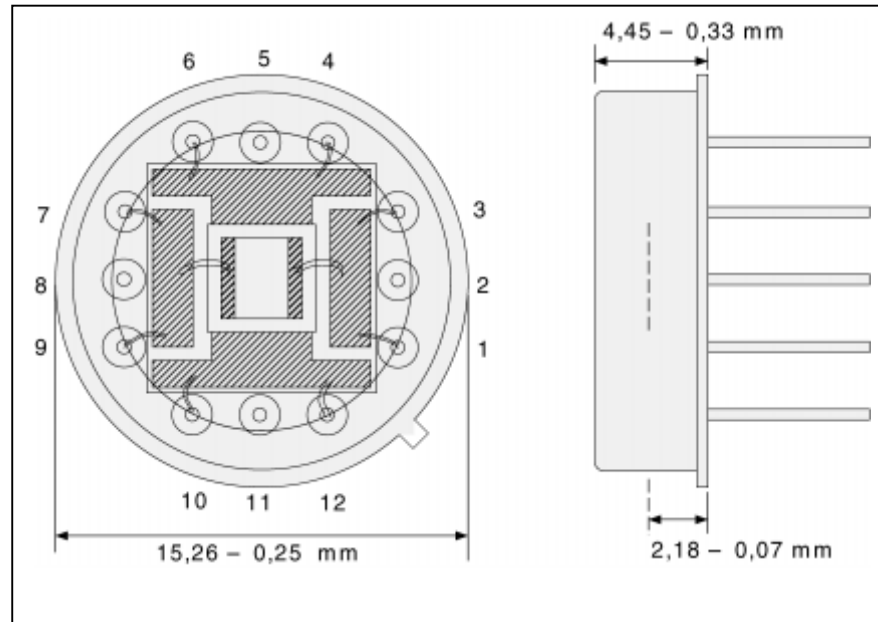
**2L2_MP1**

Pin configuration: 1,3 Output Y1
 4,6 Output X1
 7,9 Output Y2
 10,12 Output X2
 2,5,8,11 Case

Note: Outputs Y1, Y2 and X1, X2 are respectively interchangeable. The anodes Y1, Y2 must be at negative potential compared to the cathodes X1, X2.

Application information:

The inherent resolution of a PSD is very good. It is proven to be better than one part in one million. The performance of a PSD based measurement system is thus limited by its mechanical, optical and electrical components.

To get the best performance you have to consider:

- Modulated light source. Modulation makes it possible to avoid influence of other light sources.
- Stable temperature.
- Mechanical stable system.
- High optical resolution.
- High resolution in division of the sum- and difference signals.

Resolution, optical sensitivity and measurement speed are related to each other in the PSD measurement system and you have to make the proper choices and tradeoffs for your system. Further information as schematics of a recommended hook-up is obtainable from your local distributor or from SiTek Electro Optics AB.

SiTek PSD Position Measurement electronic boards:

For most position measurement applications the SiTek PM-kit offers a complete and easy-to use solution. It is a series of general purpose, high performance, low-noise electronic boards designed for SiTek PSD. You can easily build your own measurement system using our PM-kit. Further information is obtainable from your local distributor or from SiTek Electro Optics AB.

Information in this data sheet is believed to be reliable. However, no responsibility is assumed for possible inaccuracies or omissions. Specifications are subjected to change without notice.