

940nm 50W Pulsed VCSEL Diode VD-0940I-050W-XX-3A0

Features

- Single wavelength
- Good thermal conduction
- Short rise time
- Oxide isolation technology
- High reliability
- Easy to collimate

Applications

- Scanning lidars
- Laser curtain
- Range finder sensors
- 3D sensors
- Proximity sensors
- 3D detection

Part Number	Description
VD-0940I-050W-XX-3A0	940nm 50W Pulsed VCSEL Diode

PRODUCT IDENTIFY

CODE RULES:

e.g. *VD-0940 I-050 W-XX-3 A 0*

① ② ③ ④ ⑤ ⑥ ⑦ ⑧ ⑨ ⑩

- Annex, 0
- Product version, A
- Accessories, 3= pulse mode
- Package, Channel array: 1X1(A=2016, I=TO46), N=1x4, O=1x8, P=1x16
- Substrate, 1= AlN, 3= Cu/Ag
- Power units, M= milliwatt, W= watt, K= kilowatt
- Power value, 50
- Power VCSEL, I= industrial application
- Wavelength, 940 nm
- Product classification, VCSEL Diode

I. Absolute maximum ratings

Parameter	Symbol	Rating	Unit
Case Operating Temp	Top	-40 to 85	°C
Storage Temp	Tsto	-40 to 105	°C
Reflow Soldering Temperature	Tsdr	260°C(10s)	°C
Reverse Voltage	Vr	5	V
Maximum Forward Pulse Current	Imax	200 (duty cycle 0.1% max)	A
ESD exposure (Human body) model	ESD	2K	V

Note:

1. Stresses greater than those listed under "Absolute Maximum Ratings" may cause permanent damage to the device. This is a stress rating only and functional operation of the device at these or other conditions above those indicated in the operations section for extended periods of time may affect reliability.

2. In its maximum rating diode laser operation could damage its performance or cause potential safety hazard such as equipment failure.
3. Electrostatic discharge is the main reason for the laser fault of the diode. Take effective precautions against ESD. When dealing with laser diodes, use the wrist strap, grounding work surface and strict antistatic technology.

II. Optical-electrical characteristics of 1 single die.

(Top 25°C, pulsewidth 6.4ns @ 11.68kHz)

Parameters	Conditions	Symbol	Unit	Min.	Typ.	Max.
Optical Power	I _F =160A	P _o	W	40	50	52
Threshold Current	-	I _{th}	A	-	0.1	-
Forward Pulse Current	-	-	A	-	160	-
Emission Area	-	-	um	-	370x371	-
Peak Wavelength	P _o =50W	-	nm	930	940	950
Laser Forward Voltage	I _F =160A	V _f	V	38	40	42
Series Resistance	I _F =160A	R	Ω	0.24	0.25	0.26
Original Beam Angle	I _F =160A	-	Degrees	-	20	-
Wavelength Temp. drift	I _F =160A	-	nm/°C	-	0.07	-
Rise Time	-	T _r	ns	-	2.4	-
Soldering Temperature	-	-	°C	-	-	260(10s)
Duty Cycle	-	-	%	-	-	0.1
Substrate	AlN/ CuAg					

Note: Electro-Optical Characteristic with a package or diffuser would require further evaluation. Values are based on limited sample size and estimated values.

III. Environmental Specifications

Parameter	Symbol	Min.	Typ.	Max.	Units	Ref.
Case Operating Temp	Top	-40	25	85	°C	-
Storage Temp	Tsto	-40	25	105	°C	-

IV. LIV Graph, Pulse and Wavelength

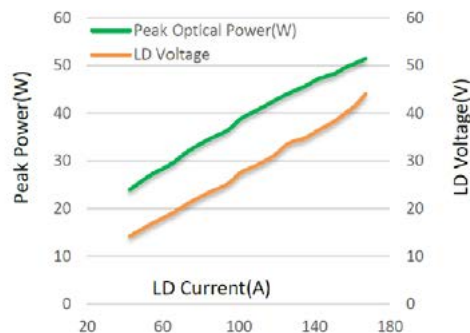

Pulsewidth=6.4ns

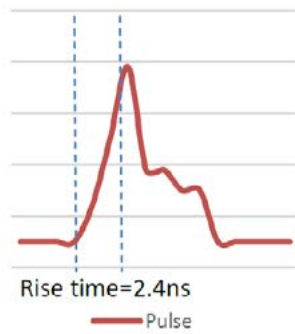

Intensity VS Wavelength
Less than 1nm

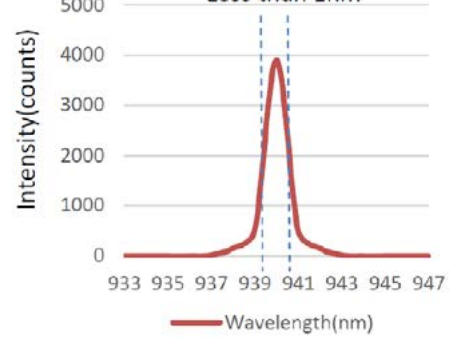

V. Mechanical Schematics (unit:mm)

VD-0940I-050W-1A-3A0 (Channel array 1X1, Substrate AlN, Package 2016)

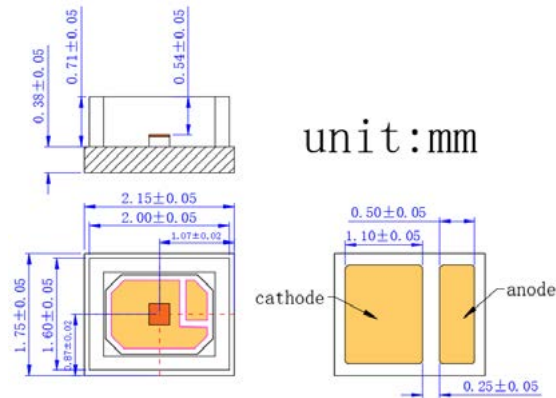

VD-0940I-050W-3A-3A0 (Channel array 1X1, Substrate CuAg, Package 2016)

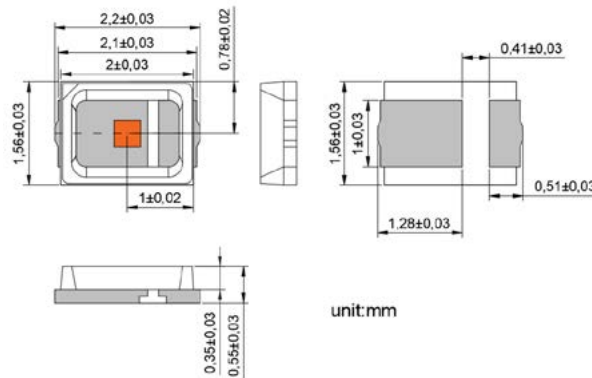

VD-0940I-050W -3I-3A0 (Channel array 1x1, Substrate CuAg, Package TO46)

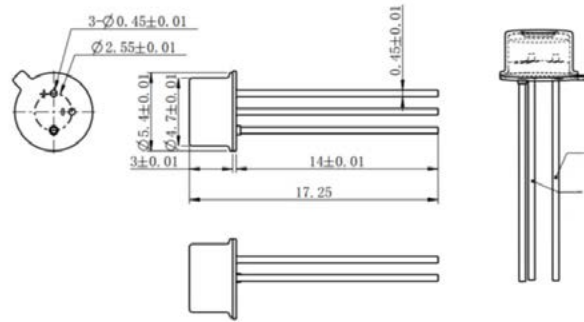

VD-0940I-050W -1N-3A0 (Channel array 1x4, substrate AlN, Package 1x4)

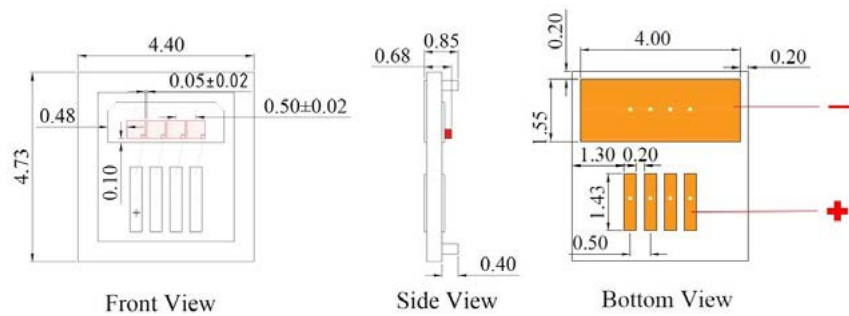

VD-0940I-050W -1O-3A0 (Channel array 1x8, substrate AlN, Package 1x8)

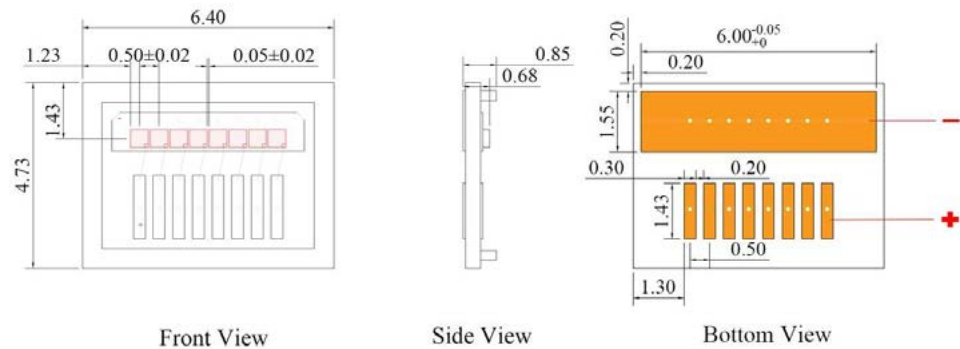

VD-0940I-050W -1P-3A0 (Channel array 1x16, Substrate AlN, Package 1x16)

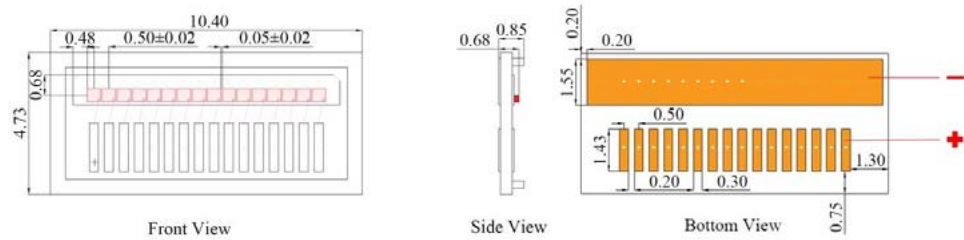

VI. SMT reflow soldering curve

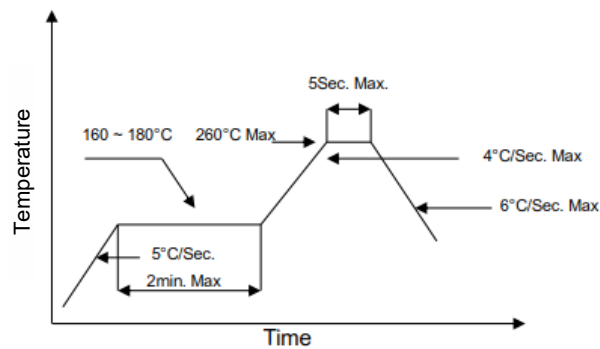

Note: Reflow soldering can be operated only one time. During the temperature ramp-up, no forces may be exerted on the LD which could deform or damage them. After soldering completed, please also do not process until the product temperature ramp down to room temperature.

VII. Treatment and protection measures

Soldering precautions

The temperature of soldering iron must be controlled under 300°C during manual soldering. Also, VCSEL can be only soldered one time with the soldering time less than 3s. But, it is very hard to control the soldering temperature and homogenize solder paste because of the smaller size of VCSEL. In addition, it is easy to damage VCSEL structure even causes VCSEL losing efficacy. So, we advise you to use re-flow soldering machine for operation.

Storage precautions

Our products were sealed by aluminum foil bag attaching packed desiccant, they are moisture proof and anti-static. Please handle these gently to avoid damage. At the same time, please be ready for storage and take some moisture-proof measures to keep VCSEL away from dampness that may

causes reliability failure.

Before opening, VCSEL must be kept below 30°C with 60% RH. Recommended to be used within 90 days.

After opening, VCSEL must be kept in an environment that temperature lower than 30°C and humidity lower than 60% RH and used up within 24 hours. When the storage humidity reaches and exceeds 60%, the products must be dehumidified at 60 °C for more than 24 hours before use.

Others

1. Please use solder paste to cure the laser diode.
2. Please make sure that the heat of VD has been completely conducted to metal shell, to avoid affecting the optical power output.
3. This VD can be only used in constant voltage and current.
4. Operating voltage and current, refer to the table in paragraph II .
5. Please do not aim the laser to people or animal.
6. You can observe the laser spot through an image monitoring equipment.
7. Please do not touch VD surface by naked hands or squeeze the sealant on VD surface, or it may cause wrong optical angle and distorted laser spot, even damage the VD.
8. Please use ceramic suction nozzle to suck on the VD, so to avoid VD sticking to the nozzle.
9. Please add a 0.02 s blowing action after locating the laser diode to aluminum substrate.

VIII. Revision history

Revision	Date	Description
V.01	2020/02/24	The first official edition
V.02	2020/04/22	Update part name
V.03	2020/12/01	Update mechanical schematic

**Brightlaser reserves the right to make modification at any time due to improved design from time to time, the merit behind is in order to supply the best product possible.

Laser diode product components are intended for use in a user-devised end system. However, these products are capable of emitting laser radiation. Extreme care must be exercised during their operation. Only persons familiar with the appropriate safety precautions should operate a laser product. Directly viewing the laser beam or exposure to specular reflections must be avoided. Serious injury may result if any part of the body is exposed to the beam. The eye is extremely sensitive to the infrared radiation and therefore, proper eye wear must be worn at all times. Use of optical instruments with these products may increase eye hazard. Always wear eye protection when operating.

