

INFRARED COMPONENTS



“Nearly every week I got new or improved lasers on my desk for testing. Improved or even new detectors are very rare.”

Peter Kaspersen, Founder of Norsk Elektro Optikk AS (NEO)

Infrared Tradition

Dear Reader,

Since its founding in 1982, LASER COMPONENTS has specialized in IR components with a focus on infrared detectors. During that time, we have acquired extensive know-how in this area. Today, customers all over the world profit from our in-house production facilities. We have had the privilege of bringing aboard specialists who are extremely familiar with the market and contribute vast expertise in R&D and production.

We have implemented different technologies in our IR detectors making it possible for our customers to always find an ideal solution. Depending on the application, one technology may be more ideal than the other. LASER COMPONENTS not only offers high quality components, but also profound technical expertise and individual assistance. This is a rare trait amongst custom manufacturers, of which we are immensely proud.

IR WORKshop

In 2012, we launched the IR WORKshop as an international platform for infrared technologies. The location of the workshop alternates between LASER COMPONENTS headquarters in Germany and leading research universities in the USA such as Princeton University and Arizona State University. The WORKshops focus on IR detectors for commercial applications, IR components, corresponding peripherals, and their applications. To create an exclusive and familiar atmosphere, only a limited number of high-ranking international experts from industry and research institutes are invited.

In 2020, we complemented our program with a digital event series that provides longer, in-depth presentations to a larger crowd of online participants. We hope that this latest addition will yield the same success as our "corporeal" WORKshops.

We wish you and your families all the best!

Yours



Patrick Paul
CEO



Patrick Paul, Managing Director



www.ir-workshop.info

CONTENT

Editorial.....	3	Editors' Choice	54
In-House Manufacturing	6	PB45 Series	56
Variety of IR Detectors.....	8	PB50 Series	58
Philosophy	10	PB55 Series	60
Applications	12	Specials, Filters and Windows.....	62
InGaAs PIN Photodiodes.....	20	Packaging	64
Tech Notes and Basics	22	Pyroelectric Detectors.....	66
Editors' Choice	26	Tech Notes and Basics	68
IG17 Series	28	Editors' Choice	74
IG22 Series	31	L11/21 Series.....	76
IG26 Series	34	LD21 Series	78
IA 35.....	37	L1x/2x Series.....	80
Packaging	38	D31 Series.....	82
PbS/PbSe Detectors.....	40	Filters and Windows.....	84
Tech Notes.....	42	Packaging	90
Basics	44	Specials.....	92
PbS Detectors	46	IR Emitters	94
Editors' Choice	46	HQE Detectors.....	96
PB25 Series	48	IR Filters	98
PB27 Series	50	Special Partner	102
PB30 Series	52	Imprint.....	109
PbSe Detectors.....	54		

In-House Manufacturing



Dragan Grubisic

LASER COMPONENTS Detector Group

Founded in 2004

Located in Tempe, Arizona, USA

The LASER COMPONENTS Detector Group was established in 2004 along with its current CEO Dragan Grubisic to start the production of Avalanche Photodiodes. Dragan's expertise in $x\text{InGaAs}$ materials subsequently led to the development of PIN photodiodes as well.

In 2015 a development division and production plant for PbS and PbSe detectors was opened. Since 2014 pyroelectric detectors are also developed and manufactured at LASER COMPONENTS. Due to these step by step extensions, state-of-the-art assembly and testing equipment is in house.





Concept of the new fab opened in 2020

(x-) InGaAs & InAs PIN Photodiodes

Our detector group manufactures lattice matched InGaAs as well as extended InGaAs PIN photodiodes and InAs PIN photodiodes. Customers can choose from different package styles, cooling features and customized designs.

PbS & PbSe Detectors

PbS and PbSe differ in typical spectral range from 1000 to 3400nm for PbS and from 1000 to 5200nm for PbSe, and these detectors are provided in cooled and uncooled configurations for a variety of applications.

Pyroelectric Detectors

Pyroelectric detectors are thermal AC detectors. In principle, they respond to any absorbed radiation. However, they are mostly used in the mid-wave (MWIR) and long-wave infrared (LWIR). Pyro detectors based on LTO are mostly used in the industry for gas analysis and flame detection or in medical applications such as anesthesia monitoring. Pyroelectric detectors based on DLaTGS are mainly used for spectroscopy (FTIR).



The team of the
LASER COMPONENTS Detector Group

Variety of IR Detectors

LASER COMPONENTS offers a broad spectrum of IR components that implement different technologies.

- InGaAs, extended (x-)InGaAs and InAs PIN photodiodes
- PbS and PbSe photoconductive mid-IR detectors
- LiTaO₃ and DLaTGS pyroelectric detectors

Gas measurements, for example, can be carried out using both PbS/PbSe or pyroelectric detectors. Depending on what exactly needs to be measured, one technology is more ideal than the other. See Figures 1 and 2 for a general comparison of the available technologies.

For optimum detector selection, testing different technologies is recommended.

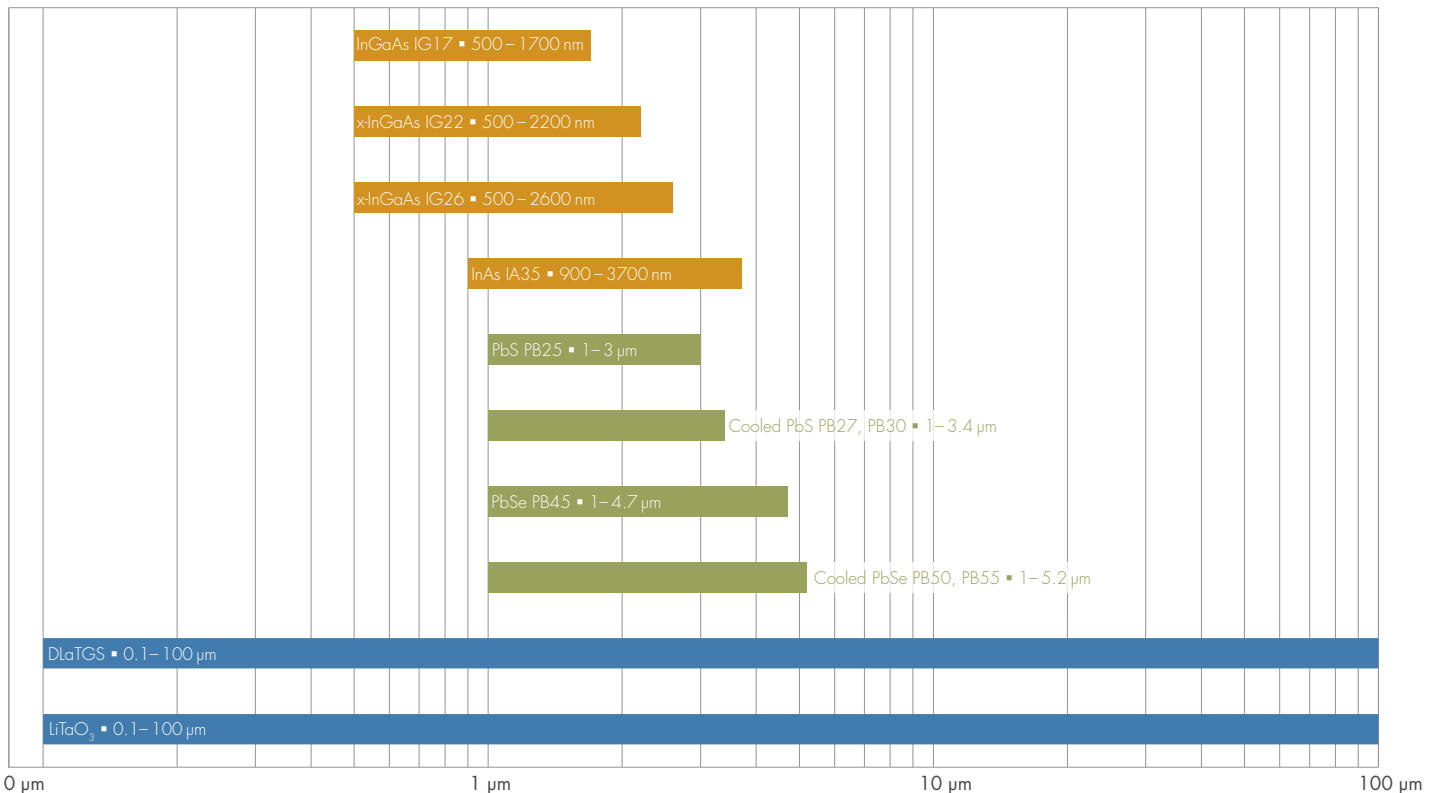

Fig 1: Spectral response of different detector materials

! Detectivity D*

The Detectivity D^* describes the quality of a detector with the following definition:

D^* represents the signal-to-noise ratio for a certain electrical frequency and bandwidth if 1 Watt of radiation power reaches a detector surface of 1 cm^2 . The higher the D^* value is, the better the detector is. NEP describes the noise equivalent power.

$$D^* [\text{cm}\sqrt{\text{Hz}}/\text{W}] = \frac{\sqrt{\text{active detector surface}}}{\text{NEP}}$$

The Unit of D^* is commonly expressed in Jones units in honor of Robert Clark Jones (American physicist, 1916–2004).

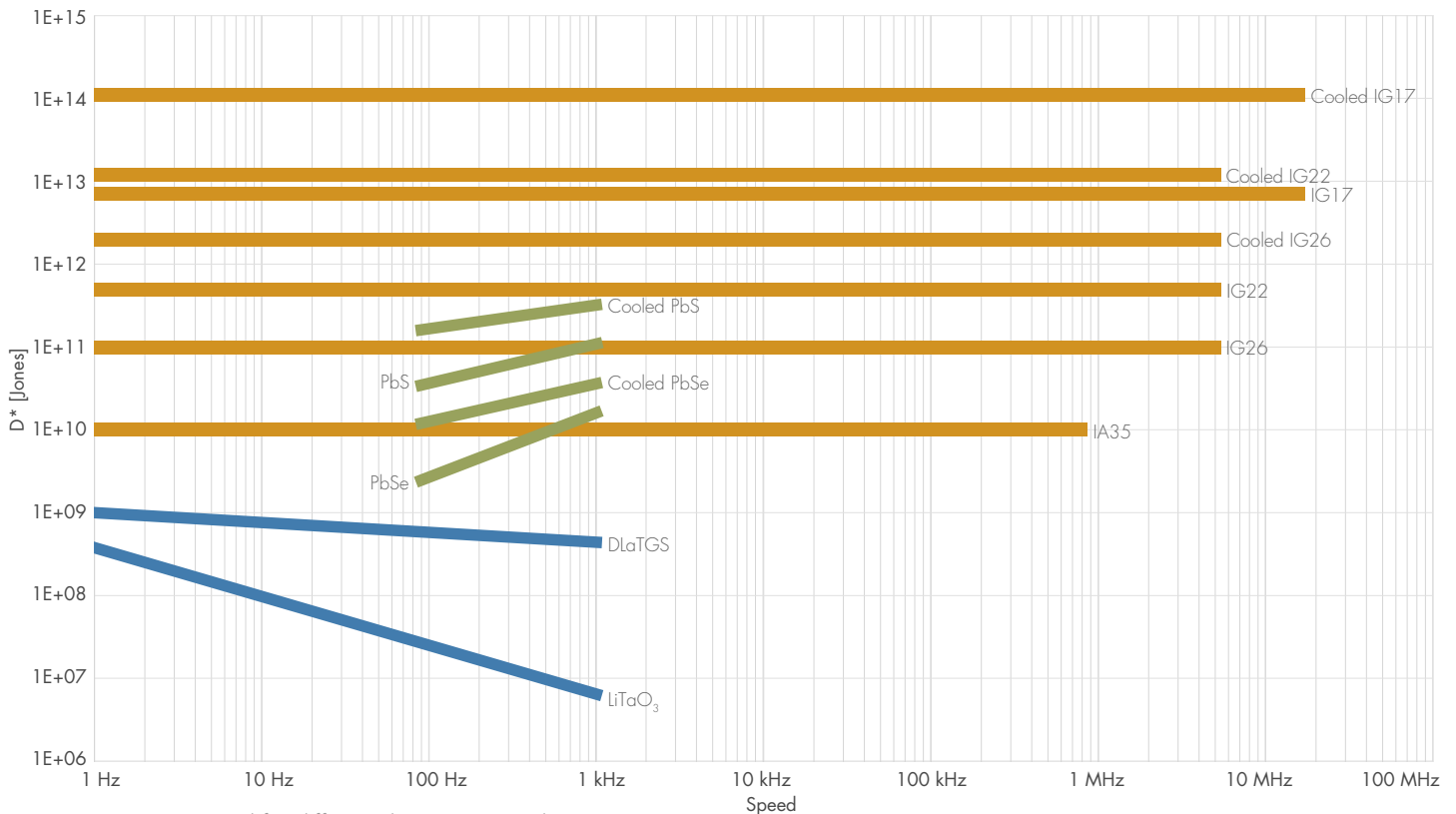

Fig 2: D^* vs speed for different detector materials

Philosophy

Application Driving Innovation

At LASER COMPONENTS, we understand that it is not the component manufacturers who drive worldwide innovation, but rather those who use our products. Therefore, we make sure to keep our finger on the pulse of new technologies, whether via one of our annual international IR WORKshop events; where we bring together academics and industrial innovators from all fields around the world together, to share their combined knowledge at our HQ in Munich or at leading research universities in the USA. The event brings about 80 attendees from all over the world together in two days. 40 talks about industrial applications and research developments in the IR community are discussed. www.ir-workshop.info

We are also a manufacturer that is dedicated to working with customers to produce detectors optimised for customer specific applications; working through several iterations to nail down the optimum specification. We are happy once we achieve a simple and clean solution!

We also understand that you want more than “just a salesperson” when looking for your next solution, and therefore our sales engineers go the extra mile to be informed about our technologies, always keeping in close contact with our development teams, academics, and even going as far as building detectors themselves at one of our annual training days!

Infrared Locomotive

We are actively pushing progress in the infrared community. In 2011, we felt that the commercial infrared community seemed a little sleepy and decided to start a series of IR WORKshops one year later. Nowadays, the activity level at infrared technologies has increased and commercial breakthroughs will follow.

We have brought serious competition into market segments which have been dominated by one company for a long period.

It has been clear to us that sooner or later; MEMS technologies will become a major driver of growth in the infrared. Very likely these technologies will need detector chips rather than packaged devices. We have been open to this idea all the time and support MEMS makers whenever possible.

Making the Unquantifiable, Quantifiable.

Our engineering philosophy is simple. Experience. Throughout our manufacturing facilities we have a combined experience of over 100 years in the infrared. We have people from many expertises coming together in the same place, sharing their ideas across many different sensor platforms. The sensors we sell and manufacture may be mature technologies; but we have endeavoured to bring the processes and understanding of the underlying mechanisms into the 21st century. Often bucking against market trends. We are turning the previous “magic” of Lead Salt detectors, which have been known for their “bucket chemistry” production methods in the past, into an exact science using state of the art analysis equipment. Not only do we have a better idea of our manufacturing process and how best to control them, but we now have a better understanding of the materials underlying quirks, which have puzzled those in the field for decades.

We have also made an exciting development in the field of pyroelectric detectors, mainly with the release of our new differential/double ended pyroelectric detector. With the use of a differential amplification scheme, we have been able to achieve a D^* of $\sim 1 \times 10^9$ Jones with LTO pyroelectrics based on standard LTO wafers. This level of performance has only before been reached with special ultrathin LTO chips, or differing materials such as TGS.

Traditionally detectors are characterized by their D^* (specific detectivity), which is a figure of merit used to characterise performance. The higher this number, the “better” the detector. This is quite understandable with defence related thermal imaging as a major technology driver; in this application, all that is desired is to “see” an event. However, in most commercial applications an event must be quantified, implying that the signal is directly proportional to the illumination; therefore, the detector must be linear. In general, reliable linearity specifications are rarely found on datasheets. We are working hard to change this for the better, but it is a rocky road:

- First, you need to be able to measure linearity precisely, quickly, and repeatedly over several decades. This could be a topic for a conference on its own! However, we have decided to follow the methods of the telecoms industry, using similar test equipment; allowing us to measure linearity directly over more than 6 decades @ $1.55 \mu\text{m}$. Of course, this is not ideal for characterisation of mid-wave infrared detectors, but it is a sound start and we will add linearity specifications over the years.
- Second, discussion regarding linearity is not commonplace at conferences and in papers. The reason might be (besides all practical problems of measurement) that there might be a trade-off among performance and linearity, and materials that appear to be superior (like MCT) are a little bit less superior when taking nonlinearity into account. So far this is just a suspicion due to a lack of detailed data.

Dear readers of this catalog: Please help us in our campaign for more transparency in the world of infrared detectors and keep on asking speakers, authors and other catalog makers for linearity data. Standardization has always been the base for commercial growth. There is absolutely no reason why infrared technologies should be any different.



Applications

IR detectors and emitters are used for many different applications such as flame detection, gas monitoring, and medical gas analysis or protein measurement. They are also used in incubators or for the inspection of surfaces.

Flame Detection

Flames are often detected in two different ways: high frequency flicker detection, or by detecting the molecules of the gases given off in combustion such as CO_2 . Combustion detection often uses a technique called non-dispersive infrared (NDIR), looking at the light emitted or absorbed by a gas with respect to a reference channel (See application section "Gas Analysis" on page 14 for more information). In flame detection, the emission of light at discrete wavelengths is measured, as at hot temperatures gases emit the same wavelength of light as they absorb.

Flame Control

In today's environmentally friendly industrial climate, if your industrial processes requires the burning of fuels the most efficient flame must be used; producing as little unwanted pollutants as possible. IR detectors are often used to monitor these products of combustion and fuel/air mixtures are adjusted to achieve the most efficient flame, producing less pollution and reducing fuel consumption.

Detectors Used for Flame Detection

Pyroelectric detectors are one of the most common detectors used to detect flames by characterizing the products of combustion. By using a 4 channel pyroelectric detector redundant information can be gained in order to eliminate false alarms. For more demanding situations PbSe can be used at $4.3 \mu\text{m}$, having the advantage of a higher D^* and high frequency operation.

Applications

This technique is used at offshore production platforms or ships, at refineries, production facilities, compressor stations, turbine enclosures, airport water curtains, and many more situations.

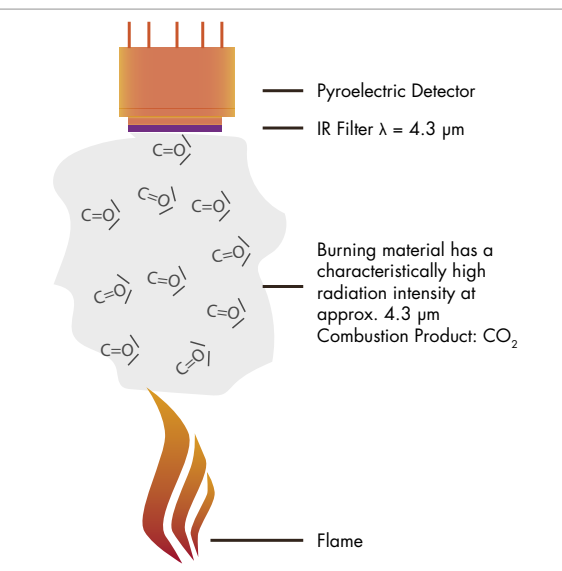

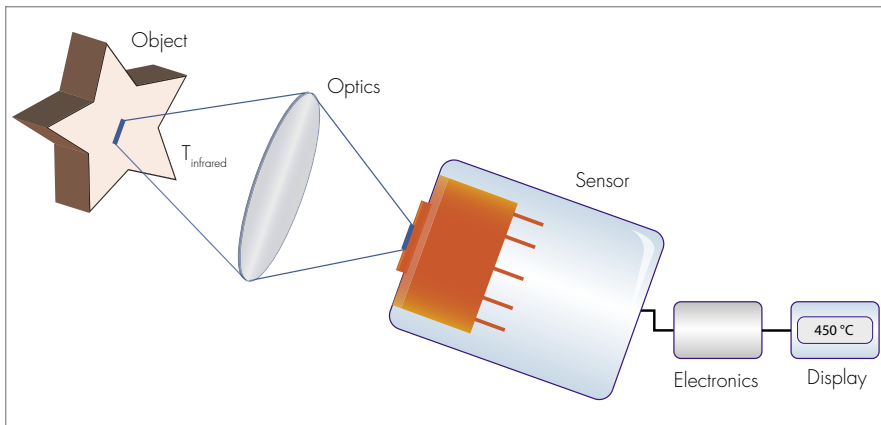

Non-Contact Temperature Measurement

Everything emits heat in the form of blackbody radiation, and this can be exploited to measure the temperature of an object without ever having to physically touch what you are trying to measure. By knowing the emissivity of the object you are trying to measure and the amount of infrared energy emitted, the temperature of the object can be calculated using the Stefan-Boltzmann law.

The type of detector used in non-contact temperature measurement varies due to many factors, but one of the largest influences is the temperature of the object you wish to detect. Hotter objects emit light at shorter wavelengths to cooler objects so the correct wavelength range must be chosen based on modeling (using Planck's and Wein's Laws) and experimentation. However, IR non-contact methods of temperature detection are most suitable for materials with a high emissivity. Materials with a high reflectivity such as gold, silver and aluminum are very hard to analyze as measured values would not represent their true temperature in the presence of background sources.

Non-contact temperature measurement is very important for quality assurance in industry for monitoring the processes in glass, plastics, and steel manufacturing; as well as environmental monitoring in geological applications. LASER COMPONENTS concentrates on supplying detectors and arrays globally to manufacturers of pyrometers for unique applications.

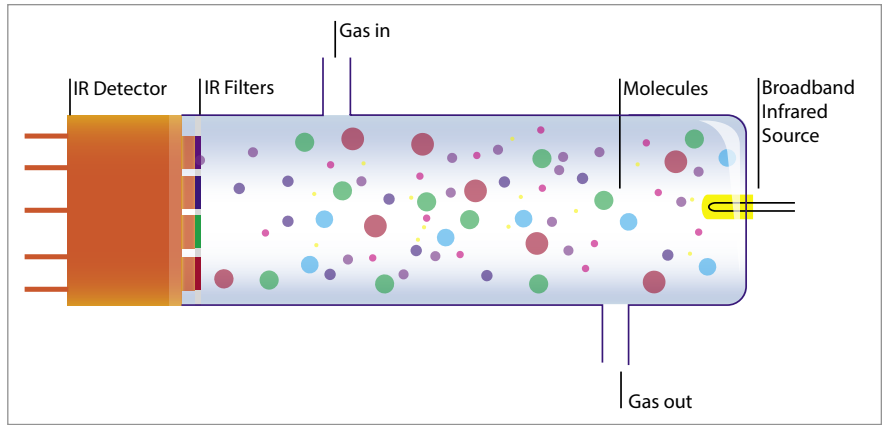

Scheme of a gas analyzer cell

! Did you already know

Everyone knows that Google uses street view cars to show 360° panoramas of many places worldwide. Nearly unknown is the fact that the cars are equipped with a measurement technology to measure methane gas leaks.

Leak detection is very important in our days as gas leaks can lead to explosions, and even small leaks cause smog condition and global warming. [1]

Gas Analysis

One of the most common uses for IR detectors is gas analysis (especially pyroelectric detectors). Most gases have their own “absorption lines” at different wavelengths of light and are targeted; using the Beer-Lambert Law to calculate the concentration. Unlike spectroscopic methods like Raman, absorption spectroscopy allows you to not only determine what gas is present; but also the concentration.

Non-Dispersive Infrared (NDIR)

NDIR is by far the most commonly used gas detection method today due to its simplicity. Gas is passed through a measurement cell where a broadband IR source is used to emit light through the cell to a detector. The detector uses IR optical filters to filter the light into an “active channel” at the absorption wavelength of the target gas and a reference channel. One of the most common gases that is detected via this method is CO_2 at approx. 4.3 μm .

The advantage of NDIR comes from the strength of absorption in the mid IR compared to methods in the near IR. This strong absorption allows relatively low concentrations of gas to be detected with small path lengths and inexpensive components. LASER COMPONENTS can provide detectors that have more than one channel with many filter options, one channel as a reference and the others for the gases you would like to detect. We also offer a filter that enables infrared humidity measurements in many applications.

NDIR is also not without its challenges: selection of the correct filters to minimize cross-talk combined with the angular and temperature dependence of these filters can cause undesired results. LASER COMPONENTS has years of experience in this field, and our standard selection of filters has been carefully chosen to help you easily find the best filters for your application.

[1] Authority: <http://techpresident.com/news/25215/google-street-view-cars-deployed-measure-methane-gas-leaks>

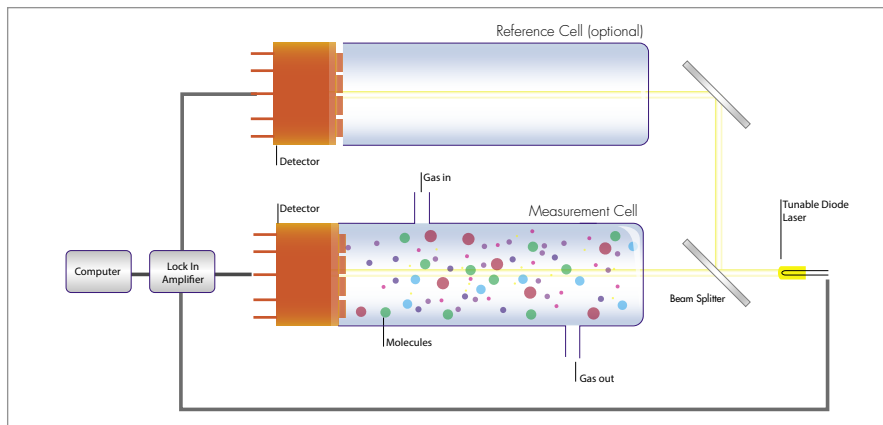

Scheme of a TDLA spectroscopy system

Tunable Diode Laser Absorption Spectroscopy (TDLAS)

TDLAS is a highly sensitive detection technique capable of resolving low gas concentrations down to ppb. A tunable laser diode such as a DFB or VCSEL is used with PIN detectors and optics to target very narrow absorption bands. Popular applications in the NIR are oxygen, water vapour, methane and ammonia detection. TDLAS has several advantages over NDIR including: faster acquisition times, high S/N ratio, and the ability to target specific gases in a family. The disadvantage is that TDLAS analysis is expensive compared to NDIR, though prices are decreasing. Applications in MWIR and LWIR are catching up due to progress with laser sources.

TDLAS takes advantage of the fact that modern semiconductor lasers can be tuned in wavelength via temperature or current tuning, allowing scanning over individual gas absorption lines. Measurements can be referenced via the two zero values either side of the absorption line. By subtracting your reference values or monitoring the ratio between the signals detected to the original intensity the gas concentration can be determined via spectral analysis.

LASER COMPONENTS supplies detectors, optics and lasers to specialists and manufacturers of TDLAS equipment.

! Did you already know

Did you know human skin has been used as a part of an infrared detection scheme for TDLAS spectroscopy?

A group from Frankfurt Johann Wolfgang Goethe-University has developed a method of glucose detection based on photothermal deflection. A pulsed QCL is used on the skin, and due to the LWIR absorption characteristics of glucose the skin absorbs a certain amount of light; heating it up. This energy is transferred to a prism via contact changing the refractive index and hence the total internal reflection. This minor change is then monitored by a second low cost probe laser. A spectrum can then be taken by tuning the QCL over a wide range giving the concentration of glucose present in the blood. [1]

[1] Authority: Pleitez M. et al., Photothermal deflectometry enhanced by total internal reflection enables non-invasive glucose monitoring in human epidermis. Analyst [2014] DOI: 10.1039/c4an01185f



© iStock.com/versevend

Industrial spectrometry application

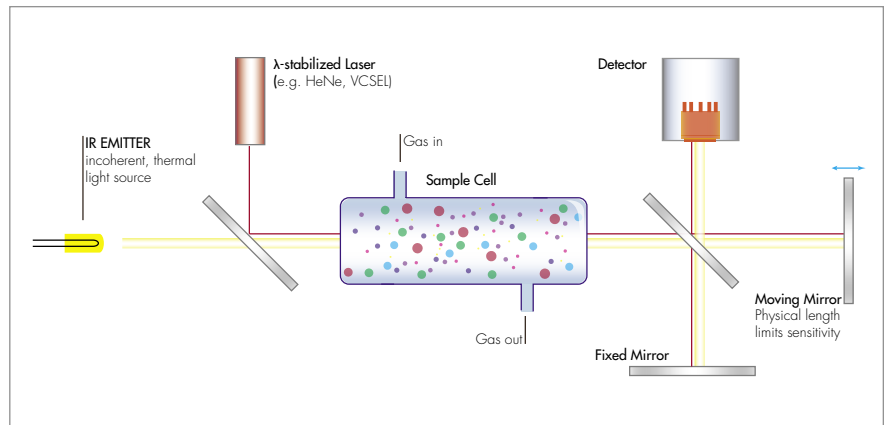

Schematic drawing of a FTIR spectrometer

Spectrometry

Spectrophotometry is an incredibly powerful method of analyzing a sample for the presence of many unknown constituents in a single measurement, provided that the absorption features are in the wavelength range of the detector used. IR spectrometry is used worldwide for any application where needing to know what chemicals and gases are present, such as environmental and urban gas monitoring, security, forensics, quality control, and biomedical analysis.

Spectrometers can be built with many different methods using arrays, single point detectors, monochromators, prisms, gratings, etc.

Fourier Transform Infrared (FTIR) Spectroscopy

FTIR spectroscopy, better known as FTIR; is the method for collecting spectral data over a wide range with a high spectral resolution. Unlike traditional spectroscopy techniques using prisms, gratings, or monochromatic sources, FTIR uses a broadband source in combination with a Michelson interferometer using wave interference to generate each individual wavelength. A Fourier transform is used to manipulate the mirror position to the specific wavelength. The precision of these scans is highly dependent on an accurate frequency reference, often provided by a known laser source.

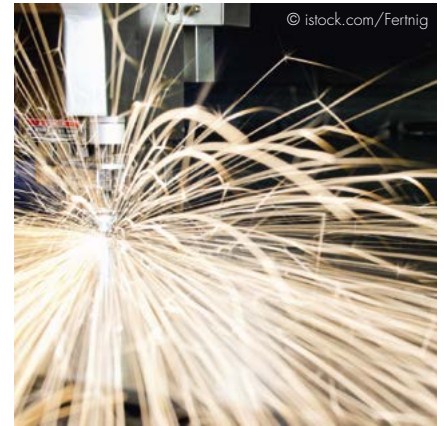
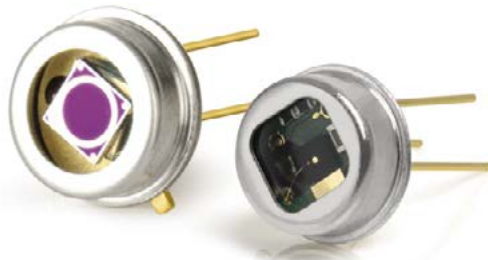

Laser cutting process

Laser Power Monitoring

Laser Power monitoring is a direct and common application for any light detector. However there is one major difference between detectors used in power meters, and those used in power monitoring; detectors for power monitoring are not calibrated to a specific power level. In power monitoring applications a detector is used to produce a feedback loop between the output of a laser and the electronics used to control it, producing a stabilized output power. Although this might sound simple, care has to be taken so a detector is not over saturated and the laser is within the detectors range of linearity. This is why beamsplitters or side reflections are used to only observe a small fraction of the laser light.

Choosing the Right Detector

In most power monitoring applications the smallest photodiode will be more than enough to do the job; however, if you are looking to record the absolute power (even in arbitrary units) then larger area photodiodes are recommended. Care also has to be taken to select the right spectral range, and effects of temperature are taken into account.

InGaAs or Silicon?

For lasers in the 900–1000 nm region silicon is still a popular choice of detector for power monitoring despite the fact that its responsivity is heavily temperature dependent in this spectral range. InGaAs on the other hand has a far better temperature coefficient over this spectral band, with our IG17 series having a temperature coefficient of $<0.1\%/K$. With the same coefficient becoming an entire order of magnitude less with our IG22 chemistry.

Pyroelectric

A high speed version with integrated OpAmp can be a sound option for applications up to a few kHz in cases where semiconductor based detectors are unsuitable.

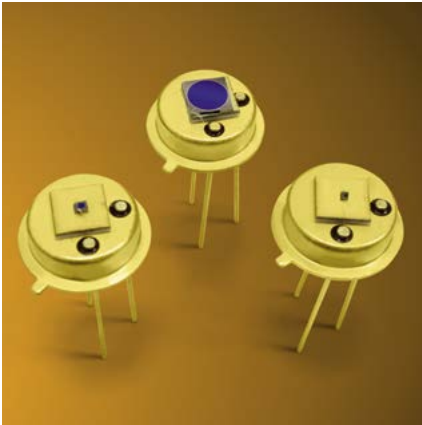

Squeezed States

Most experiments into quantum metrology run into the same problems, mainly that most detection setups are limited in sensitivity due to the quantum noise floor. This is thanks to the uncertainty principle, where the precision of the complimentary variables x (position) and p (momentum) has a fundamental limit:

$$\sigma_x \sigma_p \geq \frac{\hbar}{2}$$

Which essentially describes that the more you know about a particles position, the less you know about its momentum; and vice versa. Applications such as gravitational wave interferometry are dependent on the uncertainty principle to be able to achieve the incredibly low noise floor for their experiments.

Squeezed states of light can be used in these applications to be able to overcome this quantum noise inherent to photons, even overcoming the noise of Glauber (coherent) states; meaning that by using this little quirk of quantum optics, you can achieve uncertainty regions which are less than the circular uncertainty regions of Glauber states. Or, the uncertainty region is "squeezed". The overall area of the region stays the same, but one of the axes is pushed together; increasing your accuracy for this measurement while sacrificing the accuracy of the other. A visual representation of this is shown in the figure.

To generate a squeezed state of light, you must first have an incredibly stable and coherent state of light, then via the use of some non-linear optics (optical parametric oscillator); one pumping photon produces 2 photons which are entangled. A good way to think about how this effects your noise measurement is to think of 2 dice. When you throw the dice, they might land in the same area but the values of the dice will be different and random (an unknown quantity); the values on the dice are your "quantum noise" effecting the accuracy of your overall measurement. Imagine the entangled photon pairs as a pair of dice that always throw doubles; you always know that the dice will have an equal value (much like entangled photons), so any changes to the value of the dice would have come from an outside influence.

Recently, our high QE photodiodes were used to detect 15dB squeezed states of light¹ for the first time ever; a world record achievement for quantum optics; requiring an incredibly sensitive detector.

Details on these HQE detectors can be found on page 96.

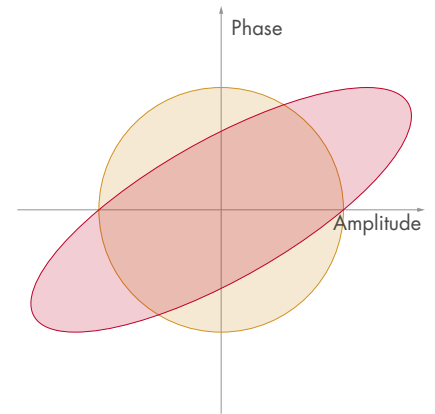

How squeezed states effect the uncertainty regions of photons

- Circular Uncertainty Region of Glauber States of Light
- Uncertainty Region of Squeezed States of Light

¹ Vahlbruch et. Al – Detection of 15dB Squeezed Stated of Light and their Application for the Absolute Calibration of Photoelectric Quantum Efficiency PRL 117, 110801 (2016)

InGaAs PIN Photodiodes



info@lasercomponents.com

You can also give us a call!

Germany | Worldwide +49 8142 28640

USA +1 603 821 7040

France +33 1 3959 5225

UK +44 1245 491499

Nordic Countries +46 31 703 7173



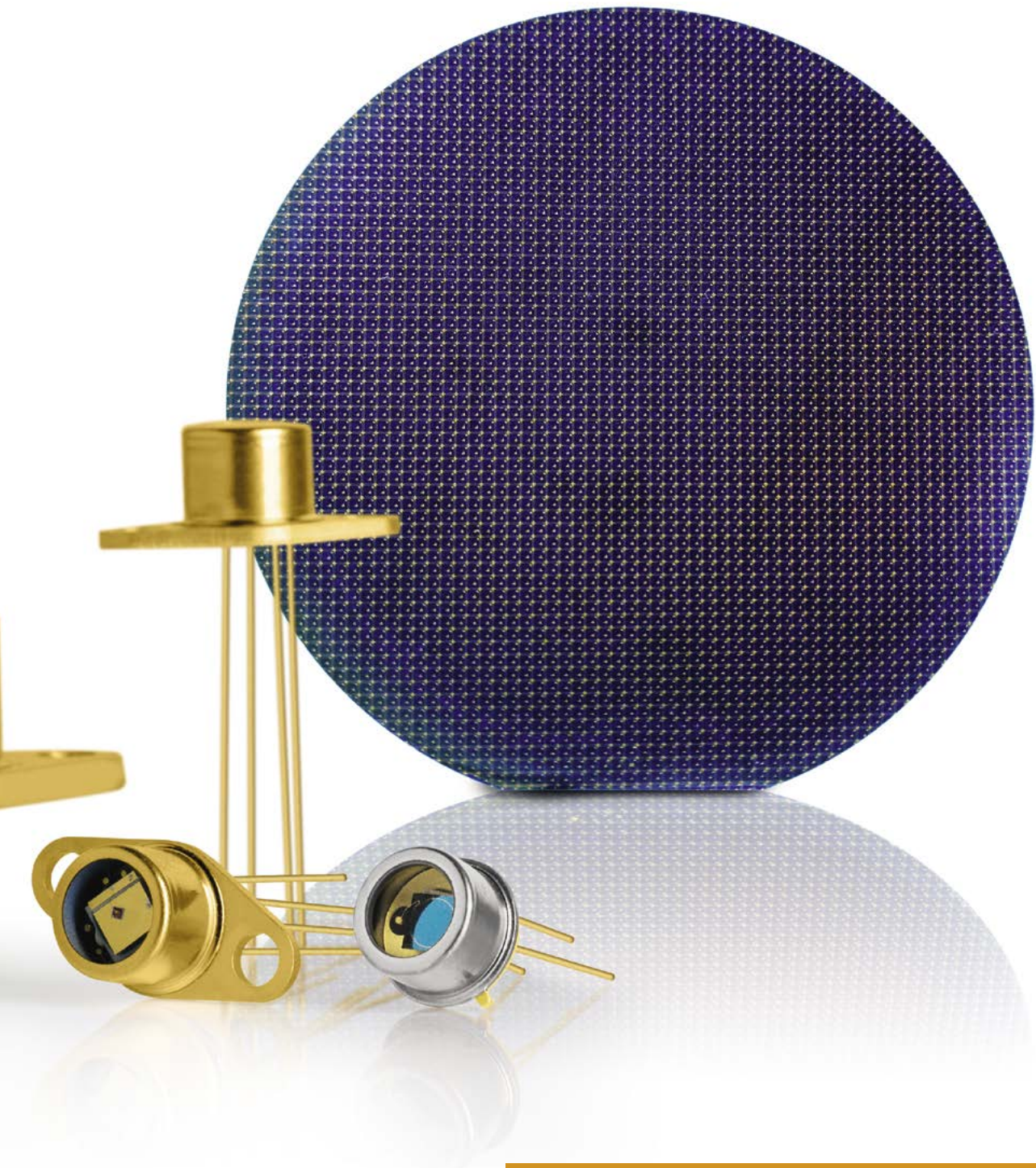

Tech Notes and Basics

InGaAs

Indium Gallium Arsenide Photodetectors are composed of two III-V semiconducting materials. They not only have applications in electronics but also in optoelectronics.

The wavelength range is enormous:

InGaAs $\lambda = 500 \text{ nm} - 1700 \text{ nm}$

x-InGaAs $\lambda = 500 \text{ nm} - 2600 \text{ nm}$

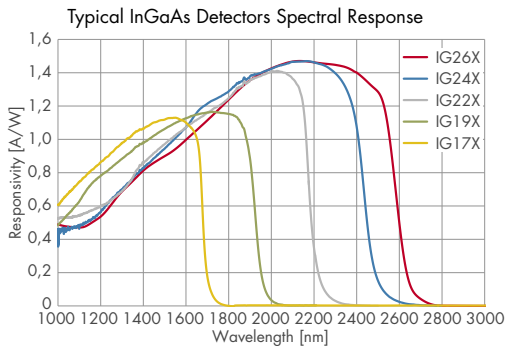

Quantum Detectors – Photovoltaic Type

InGaAs PIN photodiodes are photovoltaic quantum detectors, converting an optical infrared signal to an electrical signal. Our InGaAs PIN photodiodes are panchromatic with a sensitivity range from 500 nm up to 2600 nm.

Physical Principles

The semiconductor material absorbs incident IR photons in the intrinsic region, generating electron hole pairs which are collected at external electrodes.

Materials

Photovoltaic detectors can consist of many different materials, e.g. Ge, InAs, InGaAs, or extended InGaAs.

Advantages of InGaAs PIN Detectors

Compared to other photovoltaic materials, InGaAs has numerous advantages:

- Fast response times
- High quantum efficiency
- Low dark current and low noise

Further advantages are

- Perfect for short wavelengths
Our InGaAs PIN detectors are suited for measurements in the shorter wavelength range as they have a high sensitivity in this area.
- Eliminated off area response
- Linear at high incident of power densities
- High shunt resistance

Absolute Maximum Ratings

Storage Temperature [°C]		-55 ... +125 (+80 ^c)
Operating Temperature [°C]		-40 ... +85 (+60 ^c)
Reverse Bias, cw [V]		1 / 10 ^b / 0.25 ^c
Forward Current, cw [mA]		1 / 10 ^c
Soldering Temperature, 5 sec. [°C]		260
ESD Damage Threshold, Human Body Model Class ^a : 0 / 1A ^b , [V]		0 ... 250 250 ... 500 ^b
TE Cooler Voltage [V]	T7	0.8
	T9	3.7
TE Cooler Current [A]	T7	1.9
	T9	1.2

^aANSI/ ESD STM5. 1-2007 ^b for IG17 only ^c for IA35 only



! Handling

ESD sensitive device.

High electrostatic discharge can damage or degrade the device. Use proper ESD handling precautions.



Part Number Designation

Our product nomenclature allows you to see at a glance what's what – details are given below.

	Type	Diameter	Package Style
C- Chip only	IG17X	250 250µm	S4i TO-46, isolated
	IG19X	500 500µm	S4ix TO-46, no window
	IG22X	1000 1 mm	G1i TO-39, isolated
	IG24X	1300 1.3mm	G1ix TO-39, no window
	IG26X	2000 2 mm	G1ix TO-39, no cap
	3000 3 mm		T7 TO-37, single stage TEC
			T9 TO-66, dual stage TEC
			L5 TO-46 with lens
			M2 2 pad PCB SMD (large volume)

Standard window: Borosilicate glass

Other window materials and coating options are available on request

Note: Not every IG type is available in every chip diameter.

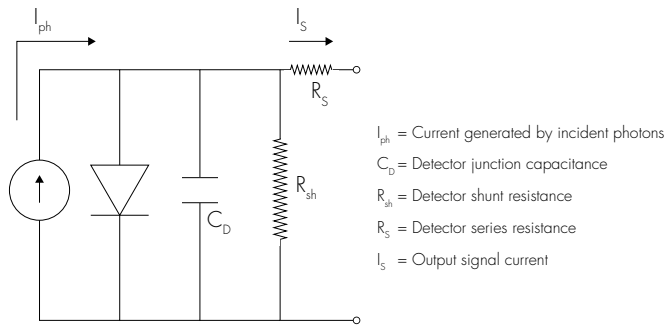

Fig 1: Equivalent circuit of a photodiode

Technical Note on Basis of Photovoltaic Detectors

Technology Basics

A semiconductor material absorbs light when the photon energy is larger than the band gap energy of the semiconductor. The absorbed photons generate mobile charge carriers. The generated carriers modify conductivity of the semiconductor in a photoconductive detector, while they are collected as a current in a photovoltaic detector.

Photovoltaic detectors are an excellent choice in many applications due to their high sensitivity, fast response, low noise and wide dynamic range. Our photovoltaic detectors are PIN junction photodiodes. The mobile carriers generated in and close to the junction's depletion region are quickly transported to the contacts by the internal electric field where they form a measurable current. The ratio of the measured current and the input light power is a major characteristic of a detector called **responsivity** (Amps/Watt). The responsivity is a function of wavelength, temperature and optical matching at the air/photodetector interface. Temperature changes affect the responsivity at the long wavelength portion of the spectral response, largely due to temperature induced changes in

the detector's material band gap energy (cut-off). Antireflective coating (AR) films are usually applied to the detector surface to increase the fraction of the light penetrating into the junction which increases the responsivity by approximately 25%.

Equivalent Circuit Diagram

The equivalent circuit of a photodiode (Fig. 1) consists of a current source I_{ph} , an ideal diode, a shunt resistance R_{sh} , a capacitance C_D and a series resistance R_s . The current I_{ph} is due to the photogenerated mobile charges and thus is proportional to the intensity of the absorbed light. The shunt resistance is the second most critical component of the circuit that needs to be as large as possible to minimize the noise and maximize the portion of the I_{ph} current (signal current I_s) available externally for measurement. Large shunt resistance values are generally associated with small values of the dark current I_d . The dark current is the component of the signal current not generated by light and it is usually a small fraction of the total signal current. The series resistance value is very small (typically 1 Ohm) to have a negligible voltage drop for light power levels generally up to

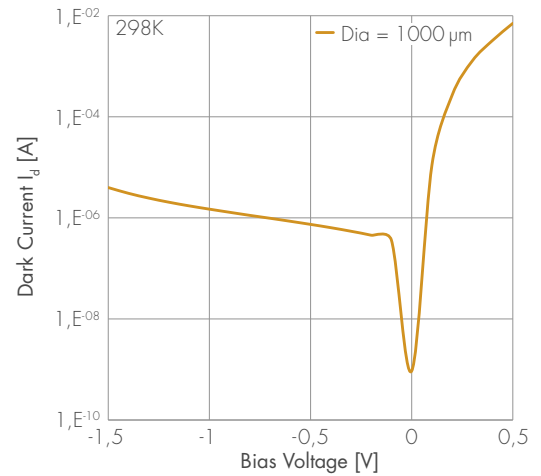

Fig 2: The importance of 0V bias

10 mW and so to maintain the linearity of the photodiode response. A diode photodetector has the best performance when its load is a "short circuit", in line with its current source model.

The Importance of 0V Bias

Biasing photodiodes is a very common practice, especially in industries that favor speed over the overall sensitivity of the photodiode; such as telecoms. However, LASER COMPONENTS' photodiodes are designed for sensing applications, where most of our users need to squeeze every last bit of performance; especially in low light conditions using the detectors in a photovoltaic regime. One of these important specifications is the Dark Current.

Figure 2 shows how even a small amount of overall biasing voltage can seriously affect the level of dark current in the device, resulting in noise. Even 10 μ V can increase the dark current significantly, especially for x-InGaAs photodiodes!

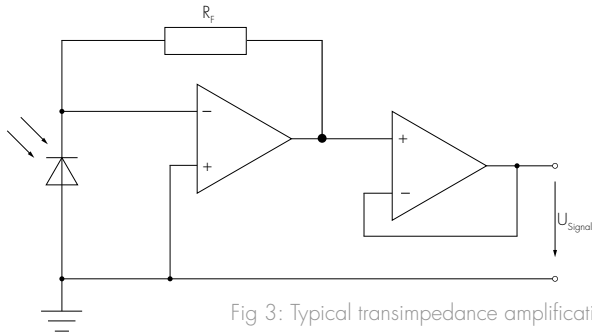

Fig 3: Typical transimpedance amplification circuit

We always recommend that care is taken to include measures to ensure that our photodiodes are operated at 0V bias with some form of voltage correction circuitry.

Amplifier Selection

The transimpedance amplifier (Fig. 3) is the recommended preamplifier circuit for a photodiode because it best approximates the “short circuit” load. The op amp of the transimpedance amplifier keeps the photodiode detector near zero volt bias (“short circuit”) and directs the signal current through the feedback resistor R_f . The amplifier output voltage is the voltage drop across the feedback resistor equal to the product of the signal current and the feedback resistance, thus converting the photodetector’s signal current to a voltage signal that can now be easily digitized, transmitted or further amplified depending on the application. A feedback capacitor can be added to limit the amplifier gain and noise at high frequencies.

Proper selection of the op amp is essential for achievement of the high performance transimpedance amplifier operation.

The desired op amp characteristics are high DC gain, high unity gain-(gain bandwidth product) frequency, low bias currents, low offset voltage and low current and voltage noise. The op amps with a JFET input stage are recommended because of their exceptionally low current noise, low voltage noise and very low bias currents and offset voltages. In the past, when selecting the op amp, one had to consider whether the shunt resistance is high or low and match the op amp noise characteristics accordingly; however, currently available low noise JFET input stage op amps make such considerations unnecessary.

Selecting Photodiodes

Photodiode selection for a particular application is a compromise of two conflicting considerations: selecting a small band gap energy photodiode detector that responds to widest possible infrared wavelength range that at the same time has very high shunt resistance to minimize the noise and dark current. However, the semiconductor physics makes it unavoidable that the smaller the band gap energy

of a semiconductor material, the smaller the shunt resistance (and the larger the dark current) of the photodiodes made from the material. That’s why one has commercially available many different photodiodes with slightly different cut off wavelengths (band gap energies) in the same semiconductor material family, such as various InGaAs compositions. The shunt resistance depends exponentially on the ratio of the band gap energy and absolute temperature

$$R_{sh} \sim \exp (E_g/kT).$$

so lowering the temperature of the diode increases its shunt resistance. Exploiting this relationship, photodiodes for high end applications are frequently operated at reduced temperature, down to roughly -50°C to increase the shunt resistance and improve the noise.

Active surface area of the photodiode is another parameter subject to compromise in diode selection since larger active area increases the photogenerated current but also lowers the shunt resistance.



Editors' Choice

Workhorse

Uncooled

IG17X1000M2	Our popular SMD version. The perfect monitor diode.
IG17X1000S4i	Our bestseller. 1 mm with glass window. Used for power meters, temperature measurement and spectroscopy
IG17X2000G1i	Good cost/detector area ratio. 2 mm with glass window. Used mainly for spectroscopy where beam stirring and sample inhomogeneities are an issue.
IG22X1000S4i	Our bestseller for the extended versions. 1 mm with glass window. Used for power meters, temperature measurement, moisture and spectroscopy.

Cooled

IG17X3000T7	For low noise when a large active area is necessary. The 3 mm detector is mounted on a single stage cooler inside the package.
IG22X250T7	For an extended wavelength range, very low noise and high speed. The 0.25 mm detector is mounted on a single stage cooler inside the package.
IG22X1000T7	Very similar to the version above. 16 times larger active area to collect the signal, but slower by the same factor.

Innovation

BICIG17X1.3SIN3.09M	Classic sandwich structure. A 3 mm silicon diode monitors the visible light while the near infrared light is transmitted and kept by the 1.3 mm InGaAs detector underneath. Our improvement is, that the InGaAs detector is well adapted to existing space, i.e. as large as possible.
---------------------	--

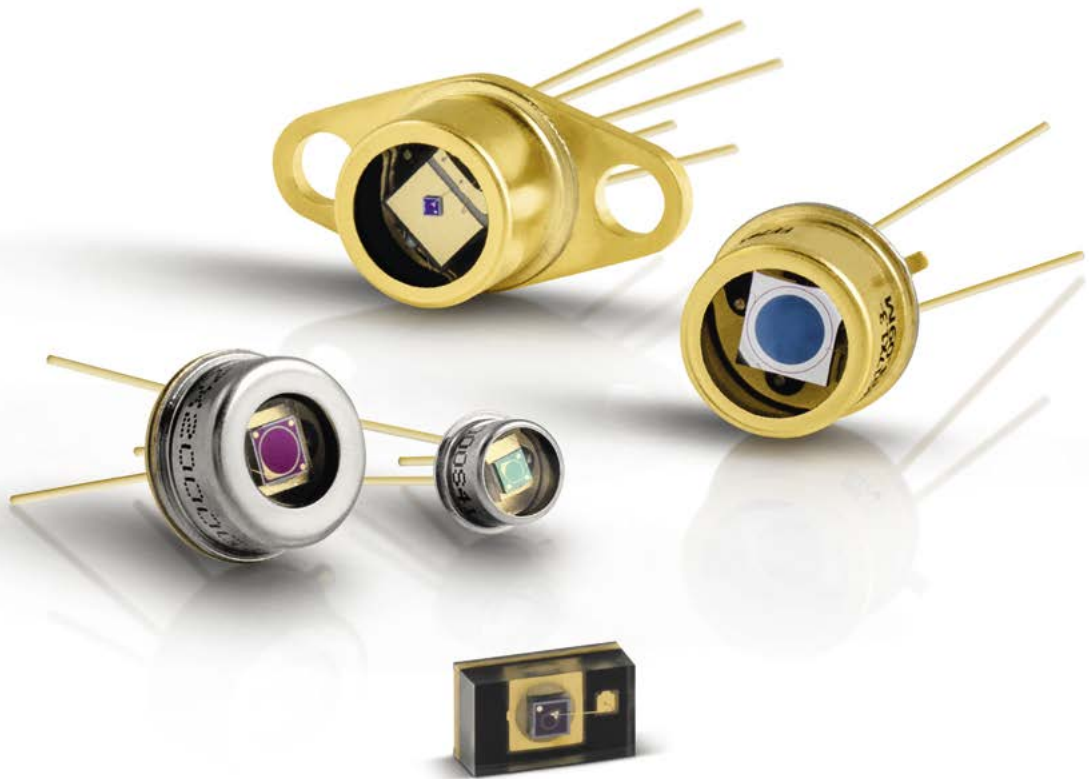

IG17 Series

InGaAs Photodiodes
(cut off @ 1.7 μm)

High Volume Option
IG17X1000M2

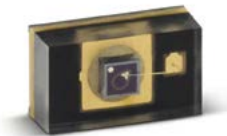

The IG17-series is a panchromatic PIN photodiode with a nominal cut-off wavelength at 1.7 μm . This series has been designed for demanding spectroscopic and radiometric applications. It offers excellent shunt resistance in combination with superior responsivity over a wide spectral range.

Features

- 50% cut-off wavelength > 1.65 μm
- Typical peak responsivity: 1.05 A/W
- Excellent temperature stability
- Reduced edge effect

Spectral Response

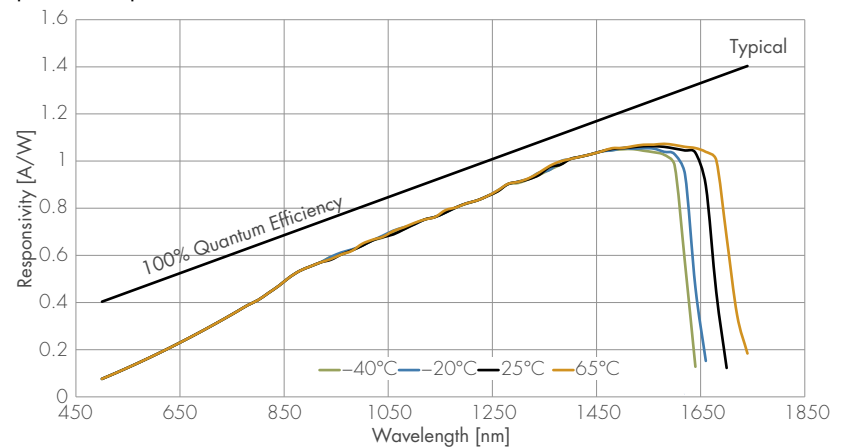

Responsivity Temperature Coefficient I

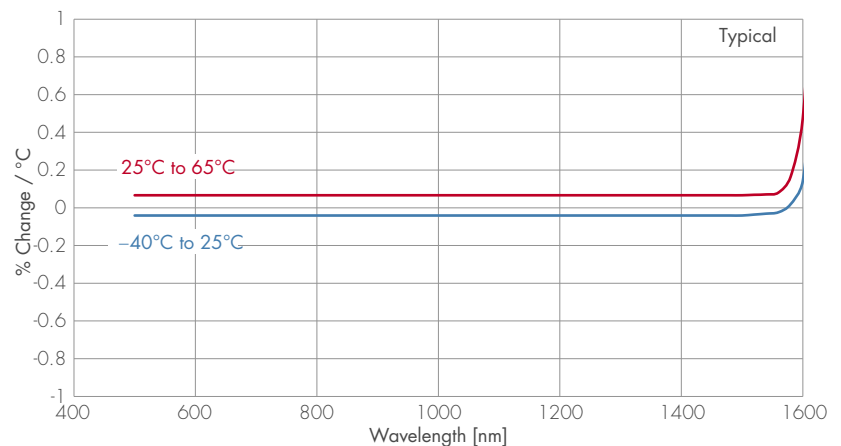

Basic Characteristics, Specifications @ 25 °C^c

Part Number	50% Cut off Wavelength ^a [μm]	Peak Wavelength ^a [μm]	Peak Responsivity ^{a,b} [A/W]		Responsivity [A/W]					
					@ 520 nm ^{a,b,d}		@ 1300 nm ^{a,b}		@ 1500 nm ^{a,b}	
		Typ.	Min.	Typ.	Min.	Typ.	Min.	Typ.	Min.	Typ.
IG17	1.65	1.55 ± 0.1	0.9	1.05	TBD	0.1	0.77	0.91	0.8	1.0

^a Parameter tested on batch level at T = 25°C. ^b Responsivity measured at 0V Bias. ^c Data are prior to window integration ^d Preliminary data

Electro-Optical Characteristics, Specifications @ 25 °C

Part Number	Diameter [μm]	Shunt Impedance @ V _r = 10 mV ^b [MΩ]		Dark Current @ V _r = 5 V ^b [nA]		Peak D* ^a f = 1 kHz [cm Hz ^{1/2} /W]		Peak NEP ^a f = 1 kHz [W/Hz ^{1/2}]		Capacitance @ V _r = 0 V ^a [pF]	Forward Voltage [V]
		Min.	Typ.	Typ.	Max.	Min.	Typ.	Max.	Typ.	Typ.	Typ.
IG17X500S4i	500	60	200	0.3	2	3.8 E+12	7.0 E+12	1.8 E-14	1.0 E-14	60	
IG17X1000S4i	1000	20	100	1	8	3.1 E+12	7.0 E+12	3.2 E-14	1.4 E-14	215	
IG17X1300S4i	1300	10	45	2	20	2.5 E+12	5.3 E+12	4.5 E-14	2.1 E-14	305	
IG17X2000G1i	2000	6	20	3	30	2.4 E+12	4.4 E+12	5.8 E-14	3.2 E-14	700	
IG17X3000G1i	3000	4	12	10	75	2.4 E+12	4.2 E+12	7.1 E-14	4.1 E-14	1550	

^a Parameter tested on batch level ^b Parameter 100% tested

See datasheet for more versions.

Thermoelectrically Cooled InGaAs Detector

Part Number	Diameter [μm]	Operating Temperature [°C]	Shunt Impedance @ V _r = 10 mV ^b [MΩ]		Peak D* ^a [cm Hz ^{1/2} /W]	Peak NEP ^a [W/Hz ^{1/2}]	Capacitance @ V _r = 0 V ^a [pF]
			Min.	Typ.	Typ.	Typ.	Typ.
IG17X3000T7	3000		20	60	9.4 E+12	1.8 E-14	1550

^a Parameter tested on batch level ^b Parameter 100% tested

See datasheet for more versions.

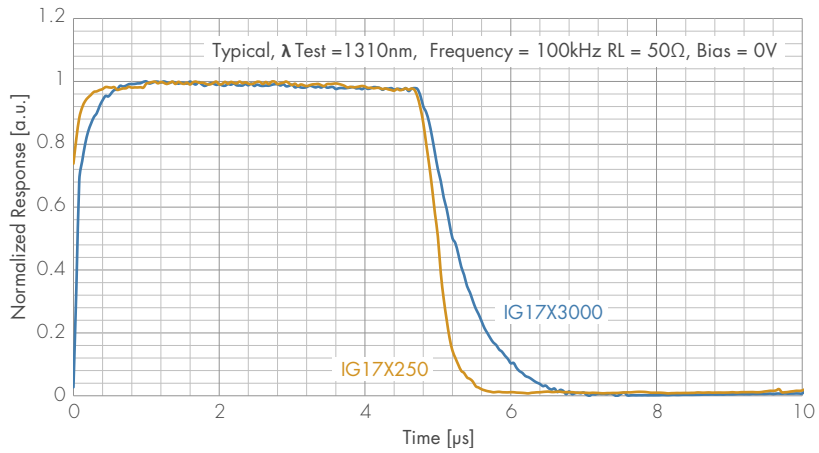

Sample Pulse Response

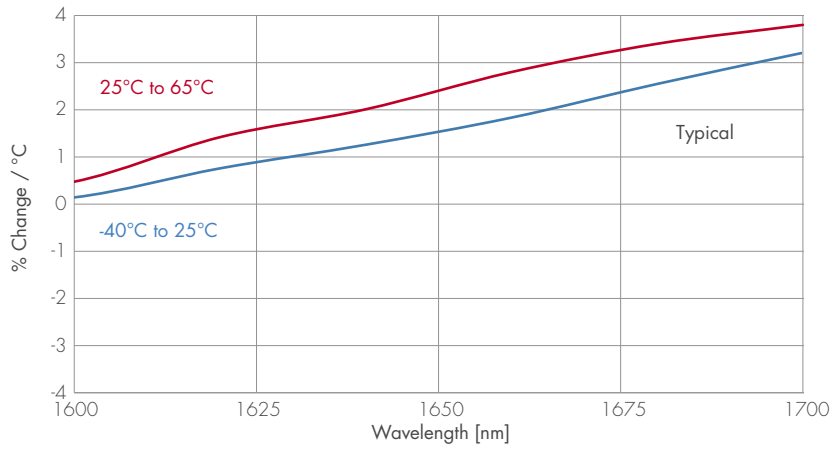

Responsivity Temperature Coefficient II

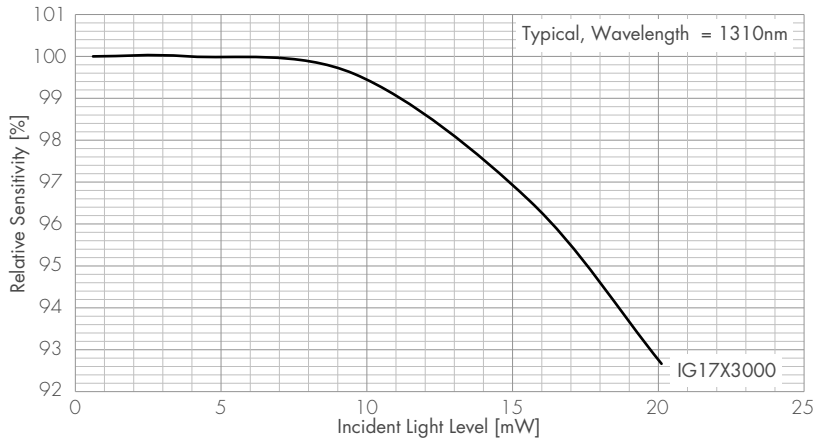

Linearity

The IG22-series is a panchromatic PIN photodiode with a nominal cut-off wavelength at 2.2 μm . This series has been designed for demanding spectroscopic and radiometric applications. It offers excellent shunt resistance in combination with superior responsivity over a wide spectral range.

Features

- 50% cut-off wavelength > 2.15 μm
- Typical peak responsivity: 1.40 A/W
- Excellent temperature stability
- Reduced edge effect

Spectral Response

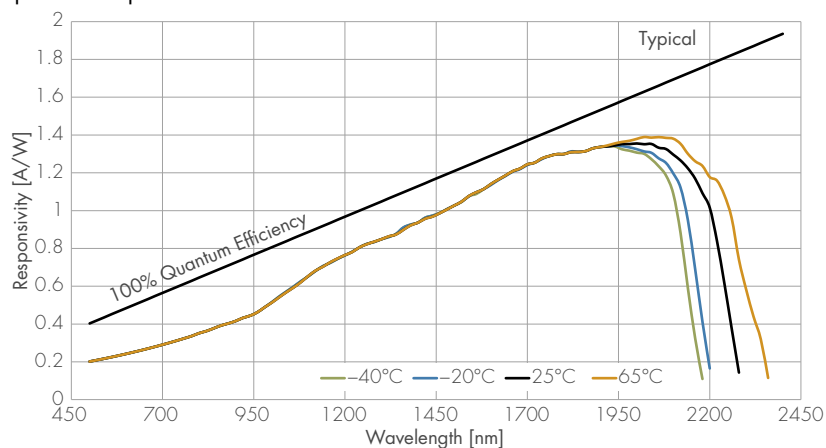

Shunt Resistance vs. Temperature

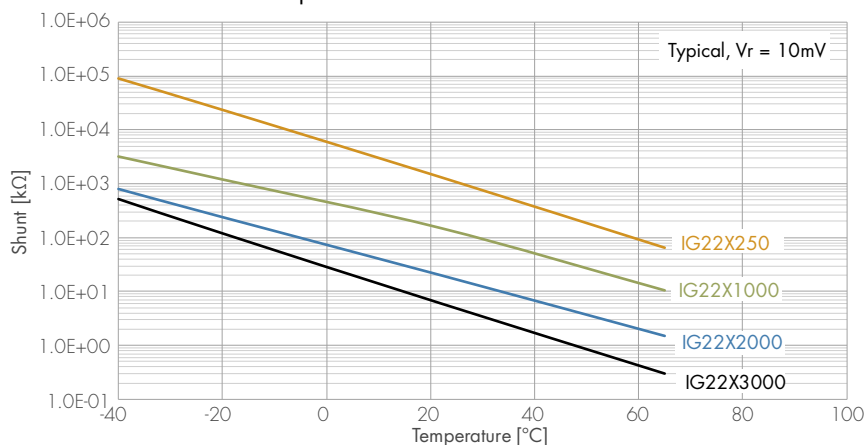

Note: For applications where shunt resistance needs to be matched, our InGaAs photodiode's shunt resistance can be tuned via. Temperature.

IG22 Series

Extended
InGaAs Photodiodes
(cut off @ 2.2 μm)



Basic Characteristics, Specifications @ 25 °C^c

Part Number	50% Cut off Wavelength ^a [μm]	Peak Wavelength ^a [μm]	Peak Responsivity ^{a,b} [A/W]		Responsivity [A/W]					
					@ 520 nm ^{a,b,d}		@ 1300 nm ^{a,b}		@ 1500 nm ^{a,b}	
		Typ.	Min.	Typ.	Min.	Typ.	Min.	Typ.	Min.	Typ.
IG22	≥ 2.15	1.95 ± 0.1	1.15	1.40	TBD	0.1	0.74	0.92	0.87	1.09

^a Parameter tested on batch level at T = 25°C. ^b Responsivity measured at 0V Bias. ^c Data are prior to window integration ^d Preliminary data

Electro-Optical Characteristics, Specifications @ 25 °C

Part Number	Diameter [μm]	Shunt Impedance @ V _r = 10 mV ^b [kOhm]		Dark Current @ V _r = 5 V ^b [μA]		Peak D* ^a f = 1 kHz [cm Hz ^{1/2} /W]		Peak NEP ^a f = 1 kHz [W/Hz ^{1/2}]		Capacitance @ V _r = 0 V ^a [pF]	Forward Voltage [V]
		Min.	Typ.	Typ.	Max.	Min.	Typ.	Max.	Typ.	Typ.	Typ.
IG22X250S4i	250	500	1000	0.05	0.5	3.1 E+11	4.5 E+11	1.6 E-13	1.1 E-13	40	0.56
IG22X500S4i	500	200	600	0.1	1	2.8 E+11	4.9 E+11	2.5 E-13	1.4 E-13	160	
IG22X1000S4i	1000	60	300	0.2	2.5	2.2 E+11	4.9 E+11	4.6 E-13	2.0 E-13	650	
IG22X1300S4i	1300	25	150	0.5	5	1.6 E+11	4.0 E+11	7.1 E-13	2.9 E-13	1100	
IG22X2000G1i	2000	12	40	1	10	1.3 E+11	2.5 E+11	1.0 E-12	5.6 E-13	1750	
IG22X3000G1i	3000	4	12	5	50	9.8 E+10	1.7 E+11	1.8 E-12	1.0 E-12	5200	

^a Parameter tested on batch level at T = 25°C. ^b Parameter 100% tested.

Thermoelectrically Cooled InGaAs Detectors

Part Number	Diameter [μm]	Operating Temperature [°C]	Shunt Impedance @ V _r = 10 mV ^b [kOhm]		Peak D* ^a [cm Hz ^{1/2} /W]	Peak NEP ^a [W/Hz ^{1/2}]	Capacitance @ V _r = 0 V ^a [pF]
			Min.	Typ.	Typ.	Typ.	Typ.
IG22X250T7	250	-10	2500	5000	1.0 E+12	5.0 E-14	40
IG22X1000T7	1000		300	1500	1.1 E+12	9.1 E-14	650

^a Parameter tested on batch level ^b Parameter 100% tested

See datasheet for more versions.

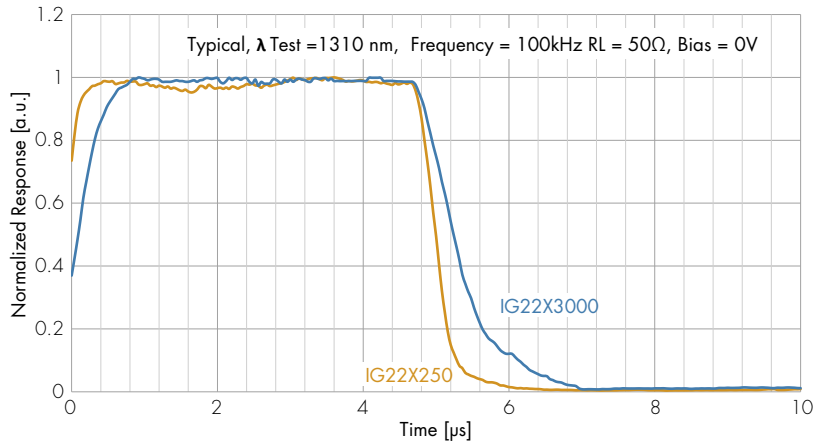

Sample Pulse Response

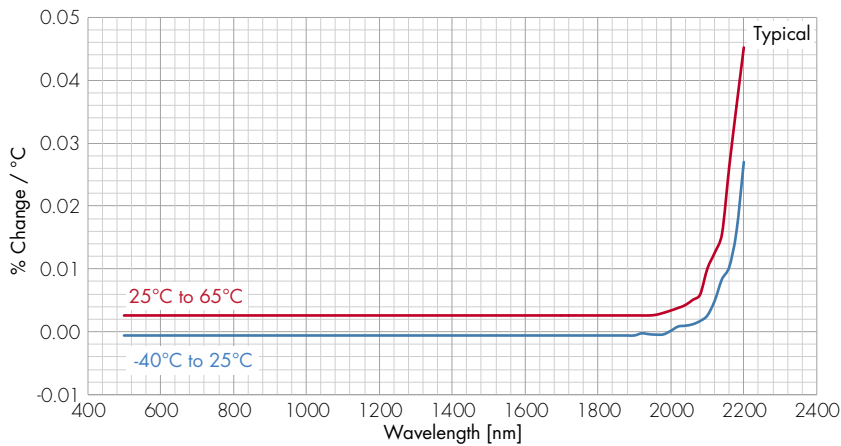

Responsivity Temperature Coefficient



Linearity

IG26 Series

Extended
InGaAs Photodiodes
(cut off @ 2.6 μm)

! Did you know?

The rise time of photodiodes is proportional to the capacitance of the photodiode itself. The higher the capacitance, the longer the rise time.

Our IG26 series capacitance is identical to our IG22 series, and therefore the rise time and bandwidth is identical.

The IG26-series is a panchromatic PIN photodiode with a nominal cut-off wavelength at 2.6 μm . This series has been designed for demanding spectroscopic and radiometric applications. It offers excellent shunt resistance in combination with superior responsivity over a wide spectral range.

Features

- 50% cut-off wavelength > 2.45 μm
- Typical peak responsivity: 1.45 A/W
- Excellent temperature stability
- Reduced edge effect

Spectral Response

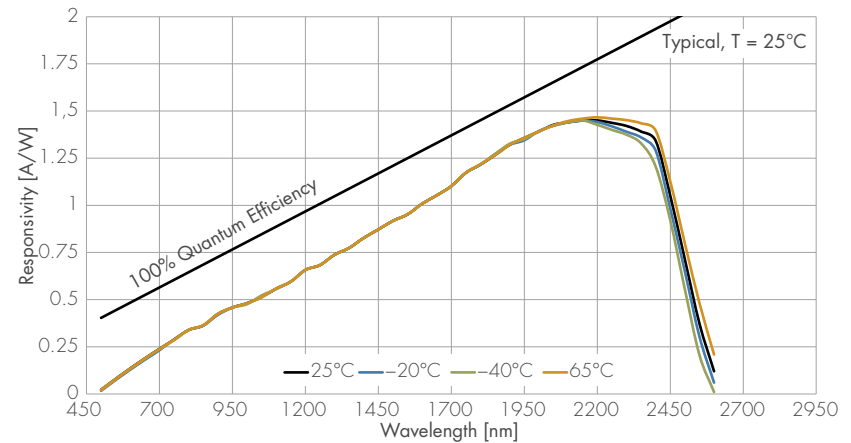

Spectral Response Zoom

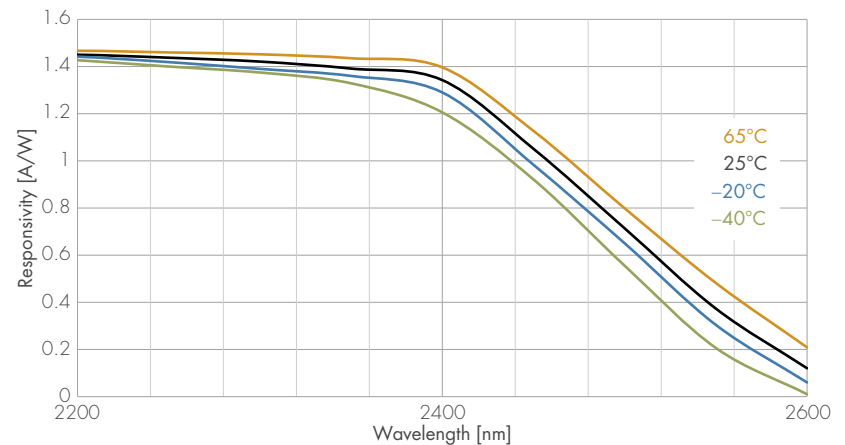

Basic Characteristics, Specifications @ 25 °C^a

Part Number	50% Cut off Wavelength ^a [μm]	Peak Wavelength ^a [μm]	Peak Responsivity ^{a,b} [A/W]		Responsivity [A/W]					
					@ 520 nm ^{a,b,d}		@ 1600 nm ^{a,b}		@ 1900 nm ^{a,b}	
					Typ.	Min.	Typ.	Min.	Typ.	Min.
IG26	≥2.45	2.25 ± 0.1	1.30	1.50	TBD	0.1	0.7	1.0	1.08	1.36

^a Parameter tested on batch level at T = 25°C. ^b Responsivity measured at 0V Bias. ^c Data are prior to window integration ^d Preliminary data

Electro-Optical Characteristics, Specifications @ 25 °C

Part Number	Diameter [μm]	Shunt Impedance @ V _R = 10 mV ^b [kOhm]		Dark Current @ V _R = 5 V ^b [μA]		Peak D* ^a f = 1 kHz [cm Hz ^{1/2} /W]		Peak NEP ^a f = 1 kHz [W/Hz ^{1/2}]		Capacitance @ V _R = 0 V ^a [pF]	Forward Voltage [V]
		Min.	Typ.	Typ.	Max.	Min.	Typ.	Max.	Typ.	Typ.	Typ.
IG26X250S4i	250	25	60	2	8	8.3 E+10	1.2 E+11	6.0 E-13	4.2 E-13	35	0.48
IG26X500S4i	500	10	25	4	25	7.4 E+10	1.2 E+11	1.0 E-12	6.0 E-13	140	
IG26X1000S4i	1000	3	9	8	75	5.7 E+10	1.0 E+11	1.8 E-12	1.0 E-12	580	
IG26X1300S4i	1300	1	4	15	150	3.7 E+10	7.6 E+10	3.0 E-12	1.5 E-12	1040	
IG26X2000G1i	2000	0.6	1.5	30	300	3.6 E+10	5.8 E+10	3.9 E-12	2.4 E-12	1920	
IG26X3000G1i	3000	0.25	0.7	75	750	2.8 E+10	4.8 E+10	6.0 E-12	3.6 E-12	3200	

^a Parameter tested on batch level ^b Parameter 100% tested

Thermoelectrically Cooled InGaAs Detectors

Part Number	Diameter [μm]	Operating Temperature [°C]	Shunt Impedance @ V _R = 10 mV ^b [kOhm]		Peak D* ^a [cm Hz ^{1/2} /W]	Peak NEP ^a [W/Hz ^{1/2}]	Capacitance @ V _R = 0 V ^a [pF]
			Min.	Typ.	Typ.	Typ.	Typ.
IG26X1000T7	1000	-10	15	75	2.9 E+11	3.5 E-13	580
IG26X2000T7	2000		3	15	1.8 E+11	7.8 E-13	1925
IG26X1000T9	1000	-20	30	150	4.1 E+11	2.5 E-13	580
IG26X2000T9	2000		6	30	2.6 E+11	5.5 E-13	1920
IG26X3000T9	3000		1	2.8	9.6 E+10	1.8 E-12	3200

^a Parameter tested on batch level ^b Parameter 100% tested

Note: The specifications for IG26 are preliminary and subject to upgrade.

IG26 Series - Curves

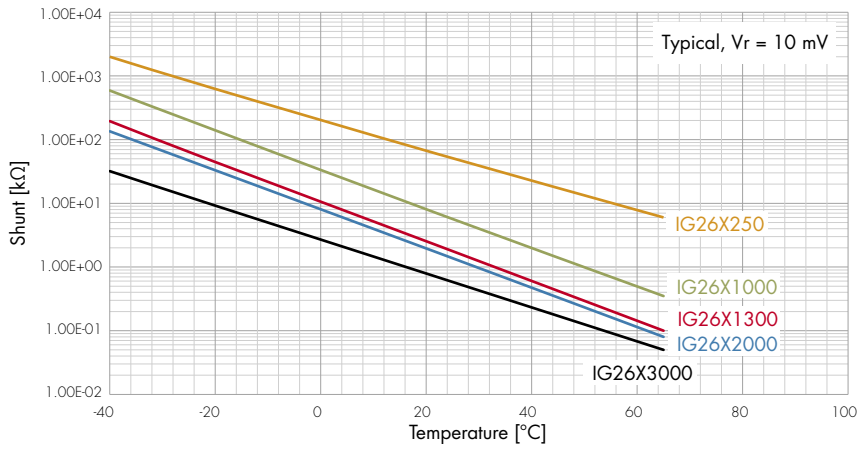

Shunt Resistance vs. Temperature

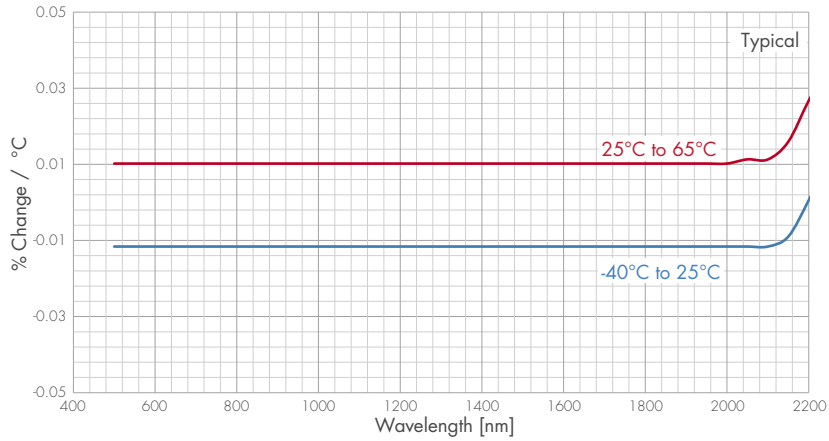

Responsivity Temperature Coefficient



Linearity

The IA35-series is a heterostructure photodiode matched to InAs substrate with a nominal wavelength cut-off at 3.5 μm .

Features

- 20% cut-off wavelength $\geq 3.50 \mu\text{m}$
- Typical peak responsivity: 1.05 A/W
- Excellent temperature stability
- Mounted in TO-46 package with sapphire window

Spectral Response

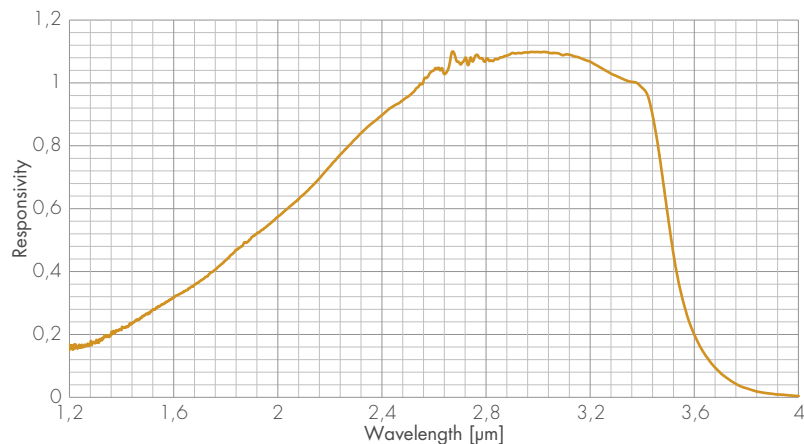

IA35

InAs Photodiode
(cut off @ 3.5 μm)

Basic Characteristics, Specifications @ 25 °C

Part Number	20% Cut off Wavelength ^a [μm]	Peak Wavelength ^a [μm]	Peak Responsivity ^a [A/W]		Responsivity [A/W]					
					@ 900 nm ^a		@ 2800 nm ^a		@ 3200 nm ^a	
					Min.	Typ.	Min.	Typ.	Min.	Typ.
IA35	3.50	2.8	0.95	1.08	n.a.	0.1	0.95	1.05	n.a.	0.90

^a Parameter tested on batch level. ^b Parameter 100% tested

Electro-Optical Characteristics, Specifications @ 25 °C

Part Number	Diameter [μm]	Shunt Impedance @ $V_r = 10 \text{ mV}^b$ [Ohm]		Dark Current @ $V_r = 0.1 \text{ V}^b$ [mA]		Peak D^*^a [cm Hz ^{1/2} /W]	Peak NEP ^a [W/Hz ^{1/2}]	Capacitance @ $V_r = 0 \text{ V}^a$ [pF]
		Min.	Typ.	Typ.	Max.	Min.	Typ.	Typ.
IA35S500S4i	500	450	700	0.15	1	1.0 E10	6.0 E-12	1000

^a Parameter tested on batch level. ^b Parameter 100% tested

Packaging

- 1 TO-46 (S4i)
- 2 TO-46 Lens Cap (L5)
- 3 TO-37 (T7)
- 4 TO-66 (T9)
- 5 2-Pad PCB SMD (M2)
- 6 TO-39 (G1i)

See datasheet for all versions and exact dimensions.

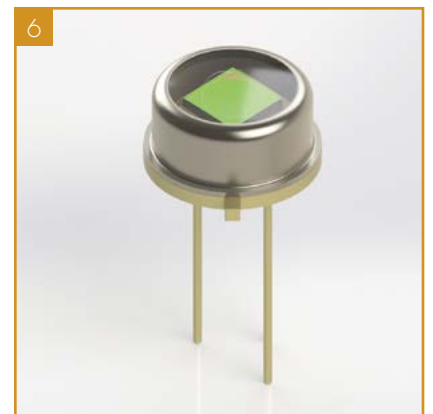
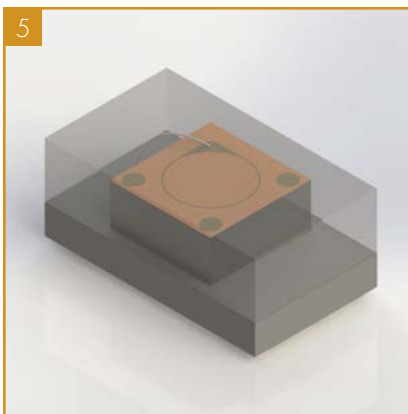
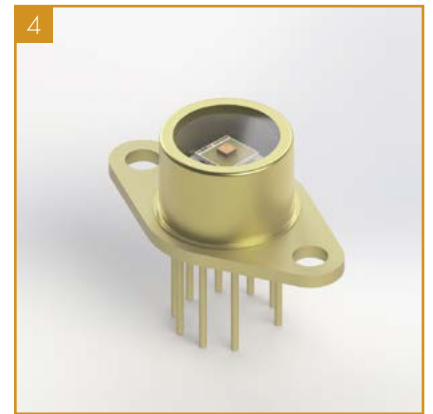

PbS Detectors PbSe Detectors



info@lasercomponents.com

You can also give us a call!

Germany|Worldwide+49 8142 28640

USA +1 603 821 7040

France +33 1 3959 5225

UK +44 1245 491499

Nordic Countries +46 31 703 7173





Tech Notes



PbS and PbSe

Lead Sulfide, PbS and Lead Selenide, PbSe detectors are both IV–VI semiconductors.

We manufacture them as polycrystalline detectors that need to be biased.

They have similar characteristics but differ in the wavelength region:

PbS $\lambda = 1000\text{--}3300\text{ nm}$

PbSe $\lambda = 1000\text{--}5300\text{ nm}$

Background

The photoconductive properties of PbS were first discovered by Kutzscher in 1930s and at the time it was the first infrared semiconductor material, with military and commercial production of PbS starting in the mid 1940s. Later, Cushman showed that PbSe also had the same photoconductive properties covering the 3–5 μm region.

Further improvements helped to expand the commercial market causing the lead salt boom in the 1950s until the 1970s; however, academics had now shifted their focus more towards MCT detectors. Lead salt detectors are now seen as a mature technology, but despite all technical competition from InGaAs, extended InGaAs, InAs, MCT, superlattices and similar materials PbS and PbSe based detectors are still a popular choice:

- PbSe is still one of the best MWIR detectors on the market for high performance without cooling.
- PbS provides the best price/performance ratio in large active areas for the SWIR region.

PbS-/PbSe- detectors manufactured by LASER COMPONENTS are manufactured via wet chemical precipitate deposition on quartz substrates: A polycrystalline film is deposited onto the substrate by generating a chemical reaction between the materials. Additives and catalytes are added to control the rate of growth and consequently the attributes of the film, with multiple layers built up in order to maximize D^* and passivation overcoatings providing chemical stabilization. A rigorous control of deposition parameters is required in order to achieve optimum composition and performance characteristics; this is achieved with state of the art computer control of the deposition process and has been a core process development at LASER COMPONENTS Detector Group.

Some groups around the world have tried, and do make lead salt detectors with modern sputtering technologies; but surprisingly, these detectors do not match the uncooled performance which has been achieved by our wet chemistry process. The reasons for this are not well understood and would require further material research, this research would be very beneficial as depositing PbS/PbSe via sputtering works very well on silicon substrates. The use of silicon substrates would allow lead salt detectors to have the potential to be used for high end monolithic MEMS devices and may cause the popularity of PbS/PbSe detectors to boom again!

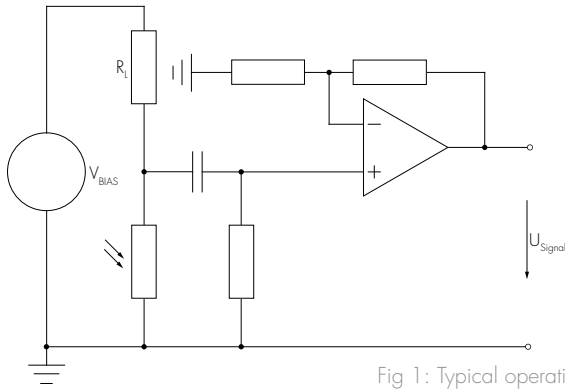

Fig 1: Typical operating circuit for IV–VI photoconductors.

Basic Principle

Recent research by LASER COMPONENTS has now shown that contrary to previous beliefs the main mechanism for PbS PbSe is not so much traditional band migration; but rather impurity trap transport in the bands. This complex mechanism causes a complex spectral response and longer response times due to an inherent time constant involved with this mechanism.

To extract a useful signal from these detectors, we can exploit this phenomenon. As light falls on the detector the electron flow increases increasing the materials conductivity; and inversely, reducing its resistance. Fig. 1: By using a load resistor R_L (typically $1\text{ M}\Omega$, as matching the detectors dark resistance will ensure the best results) is placed in series with the detector as a voltage divider, and a bias voltage V_{BIAS} is applied. As the resistance of the detector changes, the electronic characteristics of a voltage divider are used to measure the “output”. Debate continues as to whether this mode of operation is the most suitable operation method for PbS and PbSe detectors, with the Microbolometer FPA community discussing the S/N ratio advantages of current related methods.

Biasing

Our PbS and PbSe detectors are photoconductive and require a biasing voltage to operate, increasing the bias voltage increases signal and noise respectively¹. A minimum bias voltage is needed to overcome system noise and a maximum voltage cannot be exceeded due to runaway thermal effects. Historically the optimum biasing voltage has been 50V/mm with the maximum being roughly double, but progress in modern electronics means that lower voltages can now be used without making compromises in the performance. Laser Components corporate research is looking into the trade-offs.

¹ Please note, that a PbS crystal with gold contact was the first solid state semiconductor diode ever constructed, first investigated in the 1870s. Parasitic diode effects may be present at very low biasing voltages, which are not recommended.

Noise

The two dominant types of noise in a PbS or PbSe detector are generation-recombination noise and $1/f$ noise, which is why historically detector specifications are given at 1kHz to represent optimum performance. However we understand that more often than not these detectors are used at lower operation frequencies which is why LASER COMPONENTS lists D^* values for operation at 90Hz as well. As a rule of thumb, you can expect a threefold increase in noise at 90Hz when compared to 1kHz .

Note: Due to the complexity of these detectors the technical details are not fully described here. Please ask engineering for open questions.

Basics

Note

PbS/PbSe chips are available for high volume applications.

Temperature

Although PbS and PbSe are famous for their performance at room temperature in comparison to other detector technologies, the effect temperature has on the detectors themselves is incredibly important and effects the behavior of the detectors in many different ways.

Lead Salt detectors have a temperature coefficient around 4%/K, and although they can operate without a cooler it is recommended that some form of temperature stabilization is implemented; be it a Peltier cooler or not. For devices with a Peltier cooler, PbS and PbSe detectors experience an increase in their peak wavelength response the more they are cooled, an effect commonly taken advantage of through the use of coolers with differing ΔT values to help fine tune the peak wavelength response and increase responsivity. This effect is generally not well understood despite being exploited for decades as it has not been well documented due to the stochastic nature of the polycrystalline structure and wide spread manufacturing variations.

A consequence of this increased responsivity due to cooling is subtle, but still important. Photoconductive detectors' time carrier lifetimes (and hence, time constants) are directly proportional to responsivity. As you cool your device you will see an increased signal due to a responsivity increase, but your device will also become slower; the opposite is true when the device is heated as it will speed up with reduced signal. Following this responsivity/carrier lifetime relation, PbS has higher performance than PbSe by roughly one order of magnitude, but is also slower with the time constant being roughly 200 μ s compared to 4 μ s at room temperature.

Visible and UV Light

Visible and UV light can effect PbS and PbSe detectors over time, causing a degradation of the active elements or effecting the detector performance. To ensure that reliable and repeatable results are achieved the detectors should be stabilized in a controlled area which is darkened and at the same temperature they will be operated at for 24 hours prior to testing.

Currently LASER COMPONENTS still recommends using sapphire windows instead of uv-vis blocking silicon windows for several reasons:

1. Sapphire provides a better spectral range and transmission than silicon windows
2. The effects of visible light can be managed with proper handling
3. Sapphire is extremely robust
4. Silicon needs to be coated for optimum transmission

Although our standard parts use sapphire windows, we can also offer hard coated silicon windows with improved transmission in the 3–5.5 μ m range for our PB55 series.

Absolute Maximum Ratings

Storage Temperature [°C]	PbS	-70 ... +85 ^b
	PbSe	-85 ... +100 ^b
Operating Temperature [°C]	PbS	-65 ... +65 ^c
	PbSe	-75 ... +80 ^c
Soldering Temperature, 5 sec. [°C]	+250 (at pins only)	
ESD Damage Threshold, Human Body Model Class 3B ^a , [V]	8000	

^a ANSI/ ESD STM5. 1-2007 ^b operation for short-term up to storage temperature may not damage the device. It could take longer time to recover to normal operation. ^c valid for uncooled units only
The TE-Cooler ratings are listed in the datasheets

! Handling

ESD sensitive device.

High electrostatic discharge can damage or degrade the device. Use proper EDS handling precautions.



Part Number Designation

Our product nomenclature allows you to see at a glance what's what – details are given below.

Type	Window	Element Size ^a	Cooling	Package	Cap ^b
PB25 uncooled PbS detector	S sapphire	1010 1.0 x 1.0mm ²	T1 1stage	4 TO-46	S short
PB27 cooled PbS detector	G glass	1025 1.0 x 2.5mm ²	T1S 1stage superior	6 TO-8 with flange	M medium
	A Si 1.5 – 5 μm	2020 2.0 x 2.0mm ²	T2 2stage	7 TO-37	L long
PB30 ultimate cooled PbS detector	B Si 1.2 – 3.5 μm	2050 2.0 x 5.0mm ²	T2S 2stage superior	8 TO-8	X special
	C Si 1.7 μm LWP	3030 3.0 x 3.0mm ²	T3 3stage	9 TO-39	SD short with integrated LED (Note: "D" is for Diode)
PB45 uncooled PbSe detector	N Si 3.3 – 6 μm	3838 3.8 x 3.8mm ²			
PB50 cooled PbSe detector	X no window	5050 5.0 x 5.0mm ²			
PB55 ultimate cooled PbSe detector	Z Specials	6060 6.0 x 6.0mm ²			

Customer versions are available on request.

^a for rectangular elements: Space between electrodes first

^b see separate datasheet for details



Editors' Choice

Workhorse

Uncooled

PB25G10509	Popular version for fire and flame with 1x5 mm detector. Glass window.
PB25G38389	You cannot get more detector than 3.8 mm square inside a 8 mm can. Glass window.
PB25S60608M	Sample inhomogeneity is a challenge in near infrared spectroscopy. This large 6 mm detector helps to deal with it.
CL-PB25X100100	Still larger active area but needs experienced customer.
PB25G20209X-Si	This is a sandwich structure and it is used by special people that go their own way. A silicon diode monitors the visible light while the near infrared light is transmitted and kept by the PbS detector underneath. Some people who want to sort or classify things do look for differences in the visible and infrared signature. Others use the infrared signal to adjust the gain of the visible signal.

Cooled

PB27S5050T1S8M	The usefulness of this detector configuration for near infrared spectroscopy has been proven over decades. The integrated Peltier cooler is mainly used to keep the active element at a constant temperature, +5 °C is a good recommendation. The large active area helps to deal with sample inhomogeneities and enables a straightforward optical design which is an advantage over x-InGaAs photodiodes. However, photodiodes are faster and more linear. <i>Note: Separate heat sink and TEC-controller will be needed!</i>
----------------	---

Innovation

PB25G10254	Great parts are simple: Maximum detector size of 1 x 2.5 mm in a tiny package. Integrated high tech daylight filter. Maximum field of view. Minimum consumption of epoxy. Fire and flame apps are welcome. For people that like understatement and small parts.
PB25C38389SD	This is an extension of the workhorse with a very similar part code following add-ons: It does contain a near infrared LED for self testing. The glass window is replaced by a silicon based daylight filter. The filter does not just suppress daylight, it reflects the test light onto the chip as well. Control freaks like it.

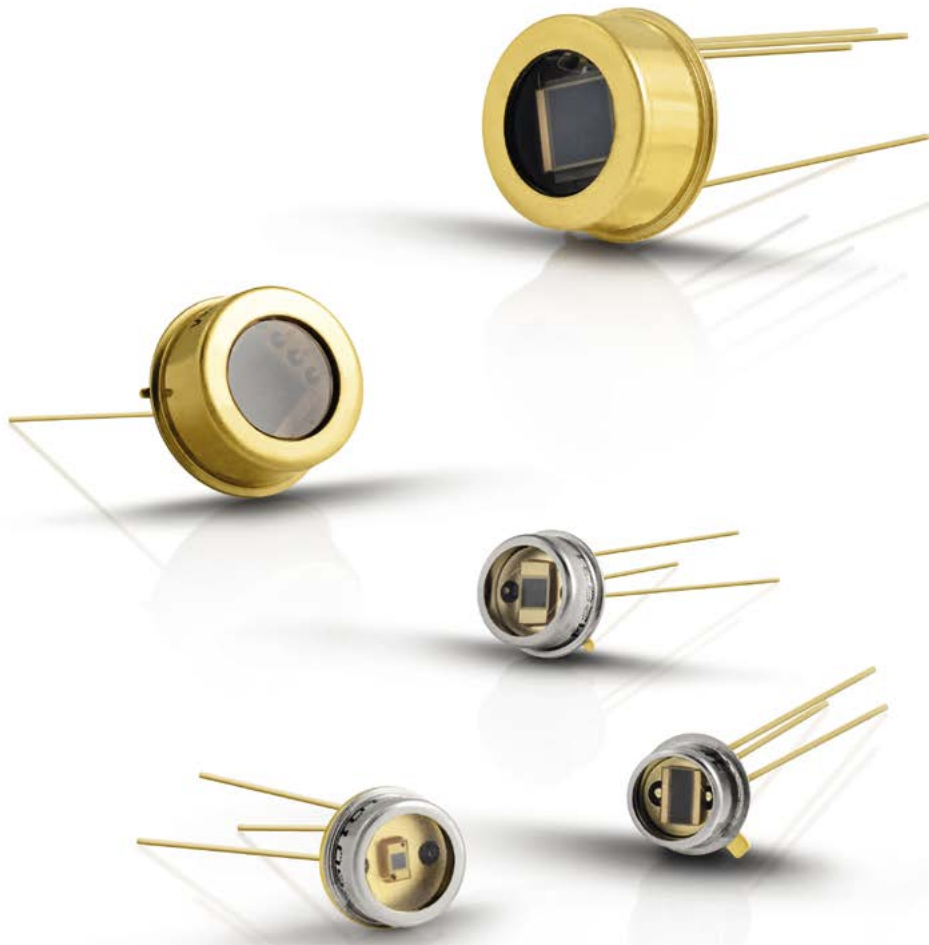

PB25 Series

Uncooled SWIR
Semiconductor Detectors
(cut off @ 3.0 μm)

The PB25 series is a collection of uncooled polycrystalline biased single element PbS detectors that operate at room temperature with a 20% cut-off of 3.0 μm . This series is widely used in analytic, safety and radiometric applications.

You may notice that extended InGaAs photodiodes such as the IG22 and IG26 series provide greater D^* than PbS detectors, so why would anybody still use PbS detectors?

PB25 detectors are still unmatched when it comes to price vs performance and spectral range for large area detectors, making them still the ideal choice of detector even though the technology is over 70 years old!

Features

- Spectral range from 1 to 3.0 μm
- State of the art performance
- 100% test data provided

Spectral Response for PB25

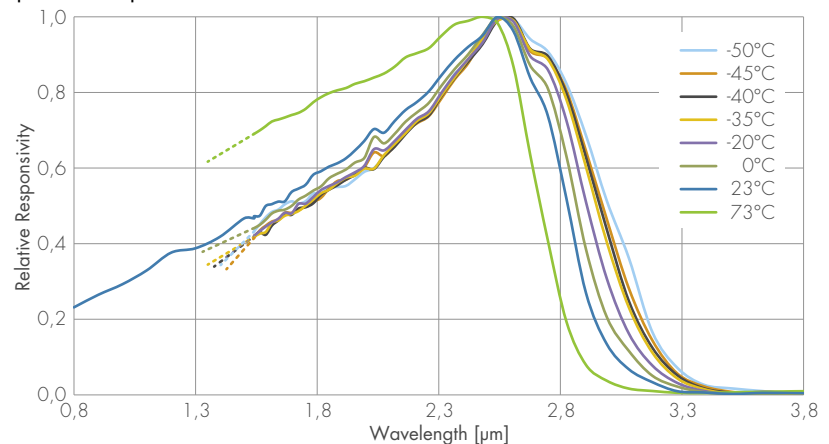

Basic Characteristics, Specifications @ 23 °C

Part Number	20% Cut-off Wavelength ^b	Peak Wavelength ^b	Time Constant ^b	
	[μm]	[μm]	[μs]	[μs]
	Typ.	Typ	Typ.	Max.
For all PB25 versions	2.6	2.4	200	400

^b Parameter not 100% tested.

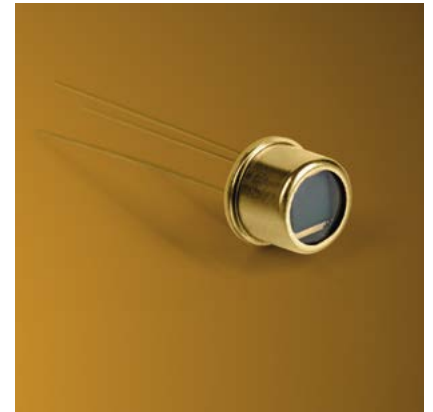

Electro-Optical Characteristics, Specifications @ 23 °C

Part Number	Aperture Size Ø [mm]	Peak Responsivity ^{ac} [V/W]		Noise Density (rms) ^a [$\mu\text{V}/\text{Hz}^{1/2}$]		Peak D* ^{abc} [$\text{cm Hz}^{1/2}/\text{W}$]		Peak D* ^{ac} [$\text{cm Hz}^{1/2}/\text{W}$]		Dark Resistance [MOhm/square]		
		Min.	Typ.	@ 90Hz ^b	@ 650Hz	@ 90Hz	@ 90Hz	@ 650Hz	@ 650Hz	Min.	Typ.	Max.
PB25G10254	3.81	220000 ^{a1}	330000 ^{a1}	TBD	TBD	2.5 E+10 ^{a1}	3.5 E+10 ^{a1}	8.0 E+10 ^{a1}	1.1 E+11 ^{a1}	0.1	0.32	1.0
PB25G20509	6.60	80000 ^{a1}	12000 ^{a1}	TBD	TBD	2.5 E+10 ^{a1}	3.5 E+10 ^{a1}	8.0 E+10 ^{a1}	1.1 E+11 ^{a1}	0.1	0.32	1.0
PB25G38389	6.60	115255	161980	TBD	TBD	2.5 E+10	3.5 E+10	8.0 E+10	1.1 E+11	0.25	0.8	2.5
PB25S60608M	9.53	90000	140000	TBD	TBD	2.2 E+10	3.0 E+10	7.0 E+10	9.0 E+10	0.2	0.8	2.5
PB25G20209X-Si	6.35	280000	400000	4.2	1.4	2.5 E+10	3.5 E+10	8.0 E+10	1.1 E+11	0.25	0.8	2.5
PB25X100100	–	50000	100000	TBD	TBD	2.2 E+10 ^a	3.0 E+10 ^a	6.0 E+10 ^b	8.0 E+10 ^b	0.25	0.8	2.5

See datasheet for all versions and dimensions.

^a Measured with 500K blackbody. Bias is 50V/mm with 1 MOhm load in series. Chopping frequency is 650Hz. ^{a1} 0.5 Mohm load series ^b Parameter not 100% tested. ^c Without filter/window

PB27 Series

Cooled Standard SWIR
Semiconductor Detectors
(cut off @ 3.3 μm)

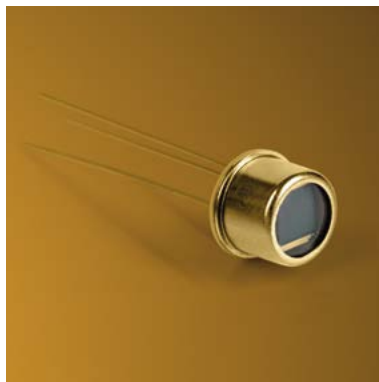

The PB27 series is a collection of TE cooled polycrystalline biased single element PbS detectors that operate at -25 °C to -35 °C with a 20% cut-off of 3.3 μm . This series is widely used in analytic, safety and radiometric applications especially when large active areas are requested.

Features

- Spectral range from 1 to 3.3 μm
- State of the art performance
- 100% test data provided

Cooling Characteristics

Part Number	Element Size [mm]	Typ. Detector Operating Temperature ^b [°C]	Max. Cooler Power	Delta T @ max. Cool [°C]		Optional Package Versions
			Typ.	Min.	Typ.	
PB27S3030T17M	3.0 x 3.0	-25	1.0 V @ 1.2 A	45	50	TO-8
PB27S5050T1S6M	5.0 x 5.0	-25	1.8 V @ 1.2 A	45	50	TO-8
PB27S6060T1S6M	6.0 x 6.0	-25	1.8 V @ 1.2 A	45	50	TO-8
PB27S3030T26L	3.0 x 3.0	-35	0.9 V @ 1.2 A	55	60	TO-8

^b Valid with sufficient heat sinking only!

Basic Characteristics

Part Number	Element Size [mm]	Aperture Size [mm]	Features	20% Cut-off Wavelength ^b [μm]	Peak Wavelength ^b [μm]	Peak Responsivity ^{ac} [V/W]		Time Constant ^b [μs]	
				Typ.	Typ.	Min.	Typ.	Typ.	Max.
PB27S3030T17M	3.0 x 3.0	dia. 6.35	1 stage cooling (1.2 W), TO-37, medium cap	3.3	2.6	430000	650000	800	1600
PB27S5050T1S6M	5.0 x 5.0	dia. 9.5	1 stage cooling superior, TO-8 flange, medium cap	3.3	2.6	260000	390000	800	1600
PB27S6060T1S6M	6.0 x 6.0	dia. 9.5		3.3	2.6	215000	325000	800	1600
PB27S3030T26L	3.0 x 3.0	dia. 9.5	2 stage cooling (1.5 W), TO-8 flange, large cap	3.3	2.6	440000	660000	1250	2500

See datasheet for all versions and dimensions.

^a Measured with 500K blackbody. Bias is 50V/mm with 1 MΩ load in series. Chopping frequency is 650Hz. ^b Parameter not 100% tested. ^c Without filter/window

Electro-Optical Characteristics

Part Number	Peak D* ^{abc} [cm Hz ^{1/2} /W]		Peak D* ^{ac} [cm Hz ^{1/2} /W]		Dark Resistance [MΩ/square]		
	@ 90 Hz	@ 90 Hz	@ 650 Hz	@ 650 Hz	Min.	Typ.	Max.
	Min.	Typ.	Min.	Typ.			
PB27S3030T17M	3.5 E+10	6.0 E+10	1.0 E+11	1.65 E+11	1.5	3.0	10
PB27S5050T1S6M	2.5 E+10	5.0 E+10	8.0 E+10	1.5 E+11	1.5	3.0	10
PB27S6060T1S6M	2.5 E+10	5.0 E+10	8.0 E+10	1.5 E+11	1.5	3.0	10
PB27S3030T26L	5.0 E+10	0.9 E+10	1.5 E+11	2.75 E+11	2.5	5.0	15

^a Measured with 500K blackbody. Bias is 50V/mm with 1 MΩ load in series. Bandwidth of test setup is 1 Hz. ^b Parameter not 100% tested. ^c Without filter/window

All specifications apply at or near max. cooling temp. with heat sink at +25 °C.

PB30 Series

Cooled Ultimate SWIR
Semiconductor Detectors
(cut off @ 3.4 μm)



The PB30 series is a collection of TE cooled polycrystalline biased single element PbS detectors that operate at -35 °C to -55 °C with a 20% cut-off of 3.4 μm . This series is widely used in analytic, safety and radiometric applications.

Features

- Spectral range from 1 to 3.4 μm
- State of the art performance
- 100% test data provided

Cooling Characteristics

Part Number	Element Size [mm]	Typ. Detector Operating Temperature ^c [°C]	Max. Cooler Power	Delta T @ max. Cool ^a [°C]		Optional Package Versions
			Typ.	Min.	Typ.	
PB30S3030T2S6L	3.0 x 3.0	-45	1.8V @ 1.2A	65	70	TO-8
PB30S5050T2S6L	5.0 x 5.0	-35	1.8V @ 1.2A	55	60	TO-8

^a Values are valid for TO-66 and TO-8 packages. ^c Valid with sufficient heat sinking only!

Basic Characteristics

Part Number	Element Size [mm]	Aperture Size [mm]	Features	20% Cut-off Wavelength ^b	Peak Wavelength ^b	Peak Responsivity ^{ac}		Time Constant ^b	
				[μm]	[μm]	[V/W]	[V/W]	[μs]	[μs]
				Typ.	Typ	Min.	Typ.	Typ.	Max.
PB30S3030T2S6L	3.0 x 3.0	dia. 9.5		3.4	2.7	500000	730000	1750	3500
PB30S5050T2S6L	5.0 x 5.0	dia. 9.5		3.3	2.6	300000	440000	1750	3500

See datasheet for all versions and dimensions.

^a Measured with 500K blackbody. Bias is 50V/mm with 1 MOhm load in series. Chopping frequency is 650Hz. ^b Parameter not 100% tested. ^c Without filter/window

Electro-Optical Characteristics

Part Number	Peak D* ^{abc}		Peak D* ^{ac}		Dark Resistance		
	[cm Hz ^{1/2} /W]		[cm Hz ^{1/2} /W]		[MOhm/square]		
	@ 90 Hz	@ 90 Hz	@ 650 Hz	@ 650 Hz	Min.	Typ.	Max.
	Min.	Typ.	Min.	Typ.			
PB30S3030T2S6L	7.0 E+10	1.6 E+11	2.2 E+11	3.2 E+11	3.0	6.0	20.0
PB30S5050T2S6L	3.5 E+10	8.0 E+10	1.0 E+11	2.5 E+11	3.0	6.0	20.0

^a Measured with 500K blackbody. Bias is 50V/mm with 1 MOhm load in series. Bandwidth of test setup is 1 Hz. ^b Parameter not 100% tested. ^c Without filter/window

All specifications apply at or near max. cooling temp. with heat sink at +25 °C.



Editors' Choice

Workhorse

Uncooled

C-PB45X0202	For smart users that want to bring mid infrared MEMS devices to lots of people: A PbSe chip with 0.25x0.25 mm ² active area. You will see, that those chips are based on 6 decades of tradition where the secrets were forwarded orally from generation to generation. Each generation did add its improvements. So did we.
C-PB45X1010	A 1x1 mm ² PbSe chip. Once again, PbSe goes towards high volume. For MEMS designers, that need a larger active area and for people that are able to treat this device with respect and even sort of love. As a result, they will experience great performance.
PB45S10254S	The largest possible active area (1x2.5 mm ²) of a high performance chip in a tiny TO-46 package.
PB45S20209S	Our classic model: 2x2 mm ² in a short TO-39 package. It plays a key role in intensive care medicine.
PB45S50508M	High performing 5x5 mm ² active area detector at a very good price.

Cooled

PB50A2020T17M	Popular choice for a high quality temperature stabilized detector in small TO-37 package with flange. 2x2 mm ² . Built in daylight suppression.
PB55N2020T28L	Our flagship detector. A very strong and efficient dual stage cooler does boost the spectral ran chips, as well as the signal to noise ratio, of carefully selected as well. The hard coated window is designed to be nearly perfect at longer wavelengths. Built in daylight suppression.



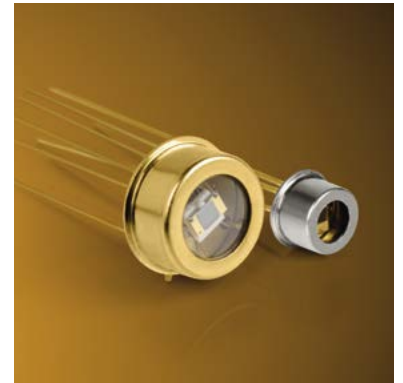

Basic Characteristics, Specifications @ 23 °C

Part Number	Element Size [mm]	Aperture Size [mm]	Features	20% Cut-off Wavelength ^b	Peak Wavelength ^b	Peak Responsivity ^{ac} [V/W]		Time Constant ^b [μs]		Optional Package Versions
				[μm]	[μm]	Min.	Typ.	Typ.	Max.	
PB45S10104S	1.0 x 1.0	dia. 3.0	TO-46	4.7	4.0	21000	42000	4	10	TO-39, short cap
PB45S20209S	2.0 x 2.0	dia. 6.35	TO-39, short cap	4.7	4.0	10500	21000	4	10	Medium cap
PB45S30309S	3.0 x 3.0	dia. 6.35		4.7	4.0	7000	14000	4	10	Medium cap
PB45S50508M	5.0 x 5.0	dia. 9.5	TO-8, medium cap	4.7	4.0	4200	8400	4	10	—
PB45S60608M	6.0 x 6.0	dia. 9.5		4.7	4.0	3500	7000	4	10	—

Further Versions in progress

^a Measured with 500K blackbody. Bias is 50V/mm with 1MΩ load in series. Chopping frequency is 1 kHz. ^b Parameter not 100% tested. ^c Without filter/window

Electro-Optical Characteristics, Specifications @ 23 °C

Part Number	Noise Density (rms) ^a [μV/Hz ^{1/2}]		Peak D* ^{abc} [cm Hz ^{1/2} /W]		Peak D* ^{ac} [cm Hz ^{1/2} /W]		Dark Resistance [MΩ/square]		
	@ 90 Hz ^b	@ 1 kHz	@ 90 Hz	@ 90 Hz	@ 1 kHz	@ 1 kHz	Min.	Typ.	Max.
	Typ.	Typ.	Min.	Typ.	Min.	Typ.			
PB45S10104S	2.1	0.7	4.0 E+09	6.0 E+09	1.2 E+10	1.8 E+10	0.1	0.8	2.5
PB45S20209S	2.1	0.7	4.0 E+09	6.0 E+09	1.2 E+10	1.8 E+10	0.1	0.8	2.5
PB45S30309S	2.1	0.7	4.0 E+09	6.0 E+09	1.2 E+10	1.8 E+10	0.1	0.8	2.5
PB45S50508M	2.1	0.7	3.0 E+09	4.0 E+09	0.9 E+10	1.2 E+10	0.1	0.8	2.5
PB45S60608M	2.1	0.7	3.0 E+09	4.0 E+09	0.9 E+10	1.2 E+10	0.1	0.8	2.5

^a Measured with 500K blackbody. Bias is 50V/mm with 1MΩ load in series. Chopping frequency is 1 kHz. ^b Parameter not 100% tested. ^c Without filter/window

PB50 Series

Cooled Standard MWIR
Semiconductor Detectors
(cut off @ 4.9 μm)



The PB50 series is a collection of TE cooled polycrystalline biased single element PbSe detectors that operate at -25 °C to -35 °C with a 20% cut-off of 4.9 μm . This series has been designed for demanding analytic, medial and radiometric applications.

Features

- Spectral range from 1 to 4.9 μm
- State of the art performance
- 100% test data provided

Cooling Characteristics

Part Number	Element Size [mm]	Typ. Detector Operating Temperature ^b [°C]	Max. Cooling	Delta T @ max. Cool [°C] ^a		Optional Package Versions
			Typ.	Min.	Typ.	
PB50S1010T17M	1.0 x 1.0	-20	1.0V @ 1.2A	45	50	TO-8, TO-66
PB50S2020T17M	2.0 x 2.0					
PB50S3030T17M	3.0 x 3.0					
PB50S1010T26L	1.0 x 1.0	-35	0.9V @ 1.2A	55	60	TO-8, TO-37
PB50S2020T26L	2.0 x 2.0					
PB50S3030T26L	3.0 x 3.0					

^a Values are valid for TO-66 and TO-8 packages. Delta T is typically reduced by 5K for TO-37 packages. ^b Valid with sufficient heat sinking only!

Basic Characteristics

Part Number	Element Size [mm]	Aperture Size [mm]	Features	20% Cut-off Wavelength ^b [μm]	Peak Wavelength ^b [μm]	Peak Responsivity ^{ac} [V/W]		Time Constant ^b [μs]	
				Typ.	Typ.	Min.	Typ.	Typ.	Max.
PB50S1010T17M	1.0 x 1.0	6.35	1 stage cooling (1.2 W), TO-37, medium cap	4.8	4.2	48000	72000	8	20
PB50S2020T17M	2.0 x 2.0					24000	36000		
PB50S3030T17M	3.0 x 3.0					16000	24000		
PB50S1010T26L	1.0 x 1.0	9.5	2 stage cooling (1.5 W), TO-8 flange, large cap	4.9	4.3	79000	120000	10	25
PB50S2020T26L	2.0 x 2.0					39500	60000		
PB50S3030T26L	3.0 x 3.0					26300	40000		

Further Versions in progress

^a Measured with 500K blackbody. Bias is 30V/mm with 1MΩ load in series. Chopping frequency is 1 kHz. ^b Parameter not 100% tested. ^c Without filter/window

Electro-Optical Characteristics

Part Number	Peak D* ^{abc} [cm Hz ^{1/2} /W]		Peak D* ^{ac} [cm Hz ^{1/2} /W]		Dark Resistance [MΩ/square]		
	@ 90 Hz	@ 90 Hz	@ 1 kHz	@ 1 kHz	Min.	Typ.	Max.
	Min.	Typ.	Min.	Typ.			
PB50S1010T17M	5.3 E+9	1.1 E+10	1.6 E+10	3.2 E+10	0.5	4.0	10.0
PB50S2020T17M							
PB50S3030T17M							
PB50S1010T26L	5.5 E+9	1.1 E+10	1.7 E+10	3.2 E+10	1.0	5.0	15.0
PB50S2020T26L							
PB50S3030T26L							

^a Measured with 500K blackbody. Bias is 30V/mm with 1MΩ load in series. Bandwidth of test setup is 1 Hz. ^b Parameter not 100% tested. ^c Without filter/window
All specifications apply at or near max. cooling temp. with heat sink at +25 °C.

PB55 Series

Cooled Ultimate MWIR
Semiconductor Detectors
(cut off @ 5.2 μm)

The PB55 series is a collection of TE cooled polycrystalline biased single element PbSe detectors that operate at -45 °C to -55 °C with a 20 % cut-off of 5.2 μm . This series has been designed for demanding analytic, medical and radiometric applications.

Features

- Spectral range from 1 to 5.2 μm
- State of the art performance
- 100% test data provided

Cooling Characteristics

Part Number	Element Size [mm]	Typ. Detector Operating Temperature ^c [°C]	Delta T @ max. Cool ^{a,b} [°C]		Optional Package Versions
			Min.	Typ.	
PB55S1010T2S6L	1.0 x 1.0	-50	70	75	TO-8
PB55S2020T2S6L	2.0 x 2.0	-50			
PB55S3030T2S6L	3.0 x 3.0	-45			
PB55S5050T2S6L	5.0 x 5.0	-45			
PB55S6060T2S6L	6.0 x 6.0	-45			

^a Values are valid for TO-66 and TO-8 packages. ^b Max. cooling: 1.8V @ 1.2 Amps (typical).

^c Valid with sufficient heat sinking only!



Basic Characteristics, Specifications

Part Number	Element Size [mm]	Aperture Size [mm]	Features	20% Cut-off Wavelength ^b [μm]	Peak Wavelength ^b [μm]	Peak Responsivity ^{ac} [V/W]		Time Constant ^b [μs]	
				Typ.	Typ	Min.	Typ.	Typ.	Max.
PB55S1010T2S6L	1.0 x 1.0	9.5	2 stage (2.5 W) cooling, TO-8 flange, large cap	5.2	4.6	120000	180000	12	30
PB55S2020T2S6L	2.0 x 2.0					60000	90000		
PB55S3030T2S6L	3.0 x 3.0					40000	60000		
PB55S5050T2S6L	5.0 x 5.0					24000	36000		
PB55S6060T2S6L	6.0 x 6.0					20000	30000		

Further Versions in progress

^a Measured with 500K blackbody. Bias is 30V/mm with 1MΩ load in series. Chopping frequency is 1 kHz. ^b Parameter not 100% tested. ^c Without filter/window

Electro-Optical Characteristics

Part Number	Peak D* ^{abc} [cm Hz ^{1/2} /W]		Peak D* ^{ac} [cm Hz ^{1/2} /W]		Dark Resistance [MΩ/square]		
	@ 90 Hz	@ 90 Hz	@ 1 kHz	@ 1 kHz	Min.	Typ.	Max.
	Min.	Typ.	Min.	Typ.			
PB55S1010T2S6L	7.0 E+9	1.2 E+10	2.2 E+10	3.6 E+10	1.0	6.0	20
PB55S2020T2S6L							
PB55S3030T2S6L							
PB55S5050T2S6L	6.8 E+9	1.0 E+10	1.8 E+10	3.2 E+10			
PB55S6060T2S6L	6.8 E+9	1.0 E+10	1.8 E+10	3.2 E+10			

^a Measured with 500K blackbody. Bias is 30V/mm with 1MΩ load in series. Bandwidth of test setup is 1 Hz. ^b Parameter not 100% tested.

^c Without filter/window All specifications apply at or near max. cooling temp. with heat sink at +25°C.

Specials

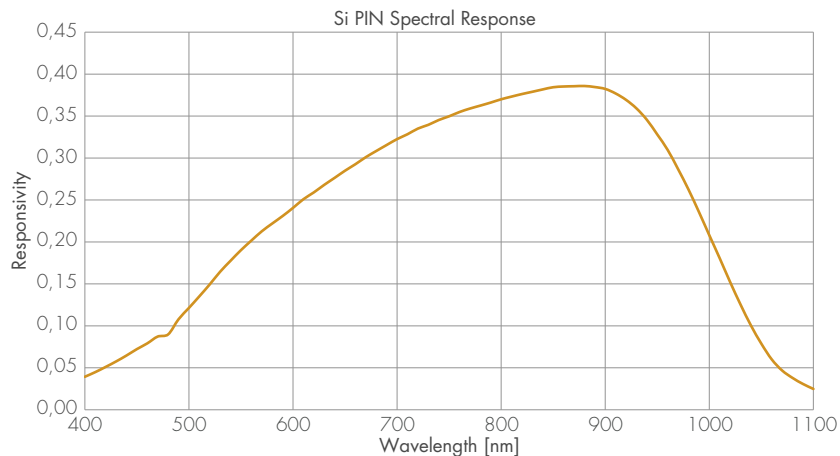
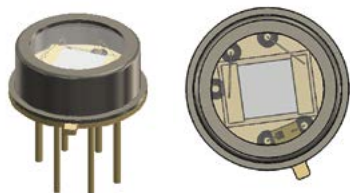

Figure showing the extended spectral range added via the addition of a Si photodiode.



We manufacture novel Lead Salt devices based on unique applications:

1. Lead Salt/Silicon photodiode sandwich detector

The Si PIN photodiode on top brings visible detection to PbS detectors (see figure 1 for additional spectral bandwidth). Example: PB25G2020X-Si

2. Combined LED and PbS/PbSe detector

Allows simultaneous illumination and detection for self testing devices. The LED packages combine an 2x2mm, or 3.8x3.8mm PbS/PbSe chip (see performance data on previous pages) with a 970nm LED (see table 1). Example: PB25C38389SD

LED Optical and Electrical Characteristics

Part Number	Forward Voltage V_F @ $I_F = 20\text{mA}$ [V]		Reverse Current I_R @ $V_R = 5\text{V}$ [μA]	Output Power ϕ_e @ $I_F = 20\text{mA}$ [mW]		Peak Wavelength λ_p @ $I_F = 20\text{mA}$ [nm]	FWHM $\lambda_{0.5}$ @ $I_F = 20\text{mA}$ [nm]	Switching Times t_r, t_f @ $I_F = 20\text{mA}$ [ns]
	Typ.	Max.	Max.	Min.	Typ.	Typ.	Typ.	Typ.
PB25C20209SD	1.25	1.45	10	1.8	2	970	35	15; 20
PB25S20209MD								
PB45C20209SD								

$T_{amb} = 25$, unless otherwise specified

PbS/PbSe detectors can be ordered with different windows or filters to enhance the transmission in the desired spectral range. Besides the standard option sapphire, also silicon windows with several anti-reflective coatings are available.

Filters and Windows for PbS/PbSe detectors

Silicon AR-coated / Silicon longwave-pass filter

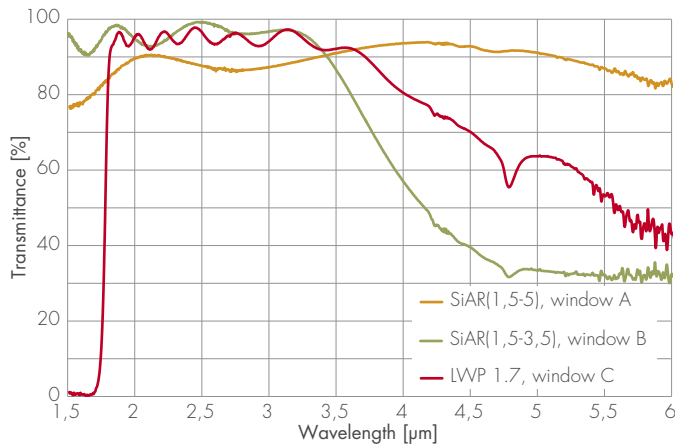

Silicon AR-coated

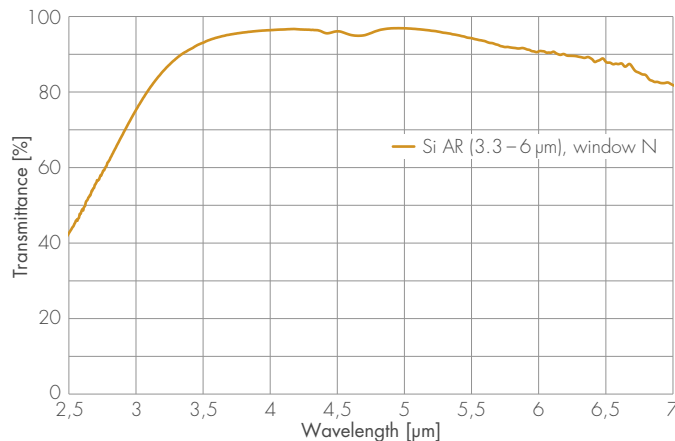

Sapphire uncoated/ BK7 uncoated

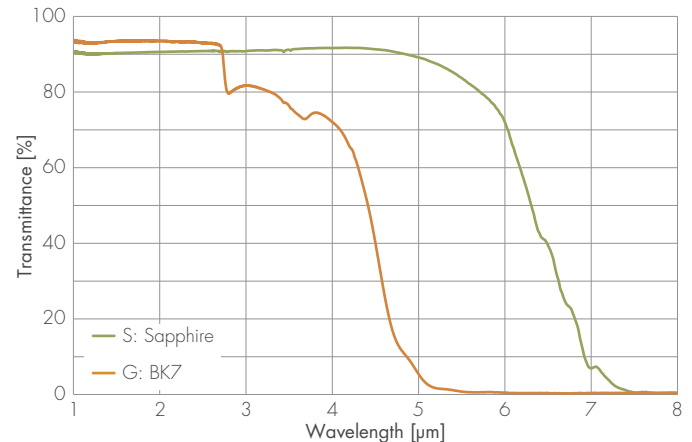

Packaging

- 1 TO-46
- 2 TO-39 (S-Cap)
- 3 TO-37 (L-Cap)
- 4 TO-8 with copper flange (equal to TO-66)
- 5 TO-8 (M-Cap)

See datasheet for all versions and exact dimensions.

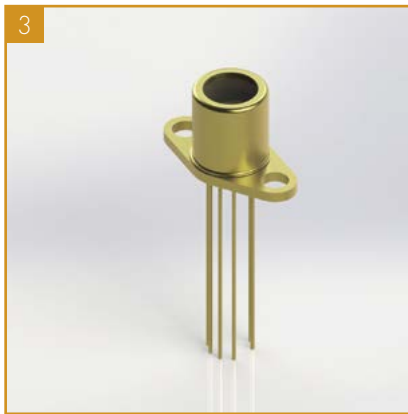

Pyroelectric Detectors



info@lasercomponents.com

You can also give us a call!

Germany|Worldwide+49 8142 28640

USA +1 603 821 7040

France +33 1 3959 5225

UK +44 1245 491499

Nordic Countries +46 31 703 7173





Tech Notes and Basics

Thermal Detectors

A pyroelectric IR detector is a thermal detector that responds to the change in heat (IR radiation) absorbed on its surface. Thermal detectors are polychromatic with a very wide spectral bandwidth.

Physical Principles

The nature of a pyroelectric effect is that in a highly ordered crystal (or ceramic) a temperature change in the crystal causes its atoms to move slightly out of position thus rearranging its electric charge; which is measured via electrodes on its surfaces.

Materials

The pyroelectric effect is found in many materials. The most commonly used materials are

- DLaTGS - Deuterated L-Alanine doped Triglycine Sulphate
- LiTaO₃ - Lithium Tantalate
- PZT - Lead Zirconate Titanate

The performance of PZT is lacking compared to the other materials.

	Units	DLaTGS	LiTaO ₃	PZT
Pyroelectric coefficient	δ [Coul/cm ² °K]	4.5×10^8	1.7×10^8	4.4×10^8
Dielectricity constant	ϵ	18	51	180
Specific heat capacity	C_v [J/cm ³ °K]	2.5	3.2	2.6
Specific AC resistance	ρ [Ω -cm]	2.4×10^{10}	4.2×10^{10}	4.2×10^9

Table 1: The properties of different pyroelectric materials used today

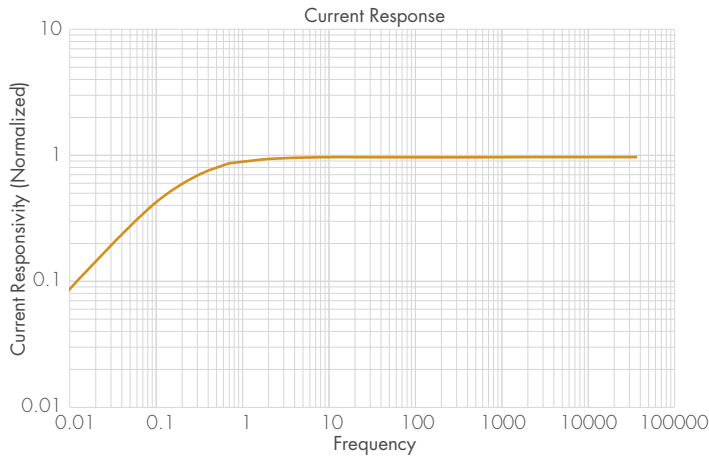

Fig. 2: Normalised current response with relation to frequency

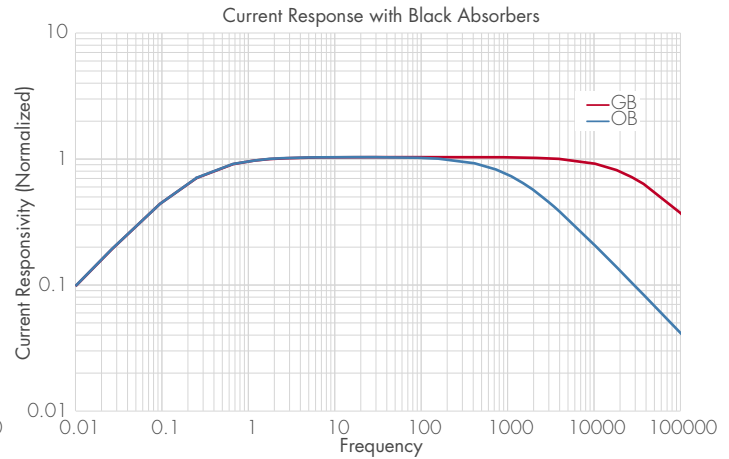

Fig. 3: Normalised current responses of LCDG's "Organic Black" and "Gold Black" coatings

Measurement Principle

The actual sensor's signal output is a change in the charge present on the active elements surface - it is caused by the temperature gradient $\Delta T/\Delta t$ as it is changing its temperature. The change in charge with time $\Delta q/\Delta t$ is the electric current (Amperes):

$$\Delta q / \Delta t = I \text{ [A]}$$

And where charge on the plates of the pyroelectric element (acting like a capacitor) can be characterised by:

$$q = \rho A_d \Delta T$$

Where:

q = Charge produced [Coul.]

ρ = Pyroelectric Coefficient [$C/cm^2 \text{ } ^\circ K$]

A_d = Area of detection element [cm^2]

As you can see, as the relationship between current and charge is dependent on changing temperature (Δt), when there is no change in temperature there is no current production. Pyroelectric detectors are AC detectors.

We can go into further depth regarding the underlying physics behind pyroelectric detectors, but we do not have enough room in this catalog!

List of abbreviations:

CM = current mode

VM = voltage mode

OB = organic black coating

GB = gold black coating

TFC = Temperature Fluctuation
Compensation

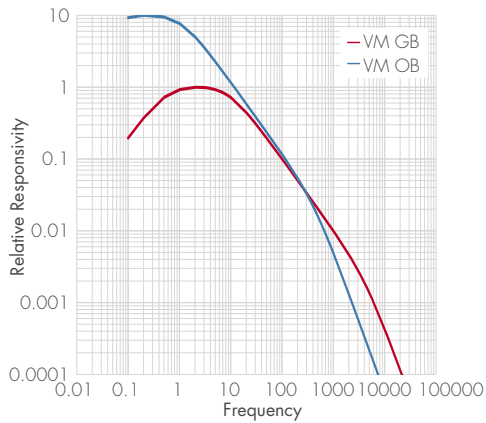
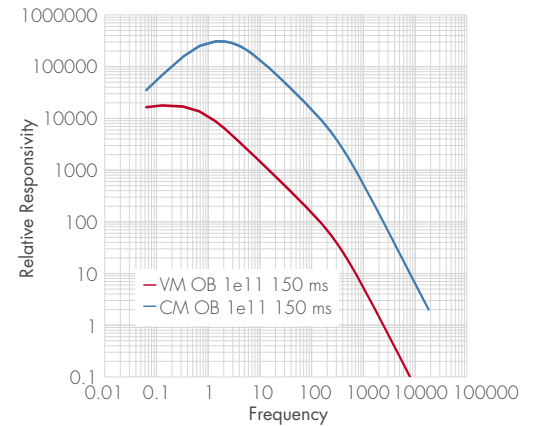

Fig. 4 (left): Frequency response of 2 VM detectors

Fig 5 (right): Responsivity compared to frequency for 2 identical detectors, with one using CM amplification (blue) and the other using VM (red)



Frequency Response

As we just learned, pyroelectric detectors cannot be used in DC operations. But that prompts the question... Just how fast can I push my pyroelectric sensor? The answer involves many different factors which will be looked at briefly here. Again, please visit our website for a more in-depth analysis.

The frequency response of a pyroelectric detector can be distilled down into these factors:

1. Thermal properties of the pyroelectric crystal
 - a. The thermal conductivity of the crystal & mounting scheme
 - b. The thermal mass of the absorber
2. The frequency response of the pre-amplifier
 - a. The value of the feedback resistor in current mode
 - b. The value of the load resistor in voltage mode

The low frequency response of a pyroelectric detector is controlled by the thermal conductivity of the crystal and the mounting scheme.

At LASER COMPONENTS Detector Group the thermal time constant can be adjusted from <5 msec to 350 msec via. material and mounting method. The higher your thermal time constant, the better your device will perform at lower frequencies. A typical current response curve for an unblackened element with a 150 msec time constant can be seen in Fig. 2 page 69.

The high frequency response of a pyroelectric is controlled by the thermal mass of the absorbing coating on the surfaces of the crystal. Although from the graph below you might first assume that this has a detrimental effect on the frequency response, please remember that this is a normalised graph; and the black coatings greatly improve the absorption of IR radiation increasing D^* significantly. We provide 2 coatings: Organic, high thermal mass black OB (for low speed applications) and "Gold Black" GB for high speed, high performance applications.

The next factor for frequency response of the output signal (or Voltage Responsivity) is the preamplifier, which is a function of both the Current Responsivity described above and the preamp gain:

$$\text{Voltage responsivity (V/W)} = \text{Current Responsivity (A/W)} \times \text{Preamp Gain (V}_{\text{out}}/\text{V}_{\text{in}})$$

Where preamp gain can be described as:

$$V/W = A/W \times \frac{R}{\sqrt{1+(\omega RC)^2}}$$

Where:

- R = Load Resistor (VM) or Feedback Resistor (CM)
- C = Detector Capacitance (VM) or Stray Capacitance (CM)

We will now compare 2 different Voltage mode detectors. One with a low thermal mass and low load resistor, and another with a high thermal mass and high load resistor (Fig. 4). As you can see, the detector with the larger resistor and thermal mass (blue) has a much larger low frequency response, whereas the detector with a lower resistor and thermal mass (red) has a better high frequency response.

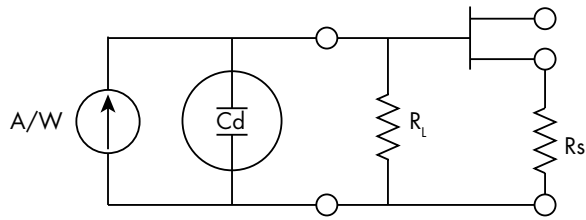

Fig. 6: Typical voltage mode operational circuit (source follower)

Electric Circuit

A pyroelectric detector is modelled as a current source $[A/W]$ in parallel with a capacitor $[Cd]$. These high impedance sensors must be coupled to an impedance matching amplifier, either a FET follower (voltage mode, Fig. 6) or a transimpedance amplifier (current mode, Fig. 7). There are certain trade-offs in choosing the VM or CM configuration.

Voltage Mode

JFET-based voltage mode has been widely available for a long time; however, it has critical disadvantages and is now used mostly by experienced users; producing a relatively low signal on a strongly temperature-dependent offset. But this mode of operation also has some advantages: JFETs are cheap and the amplification is flexible.

Current Mode

In current mode, a high signal is produced on a low offset with relatively low temperature dependence. Current Mode, whilst not a “new” breakthrough; has recently become much more viable and affordable due to the advances in semiconductor manufacturing, allowing for small and low power Opamps to be manufactured.

The low output impedance of Opamps leads to additional EMI advantages.

For high-end designs at low frequencies similar values for D^* are achieved as with voltage mode. However, unlike voltage mode detectors, current mode detectors have a very large output (due to the large transimpedance gain), which means they can be used to directly drive post-processing electronics like microprocessors, without the use of a pre-amplification stage¹. This makes them ideal for modern applications and those new to the detectors, slashing development time.

Noise in Pyroelectric Detectors

Full notes regarding noise in pyroelectric detectors can be found on our website under application notes. Noise in pyroelectrics is a complex matter, but well understood. The main noise drivers in pyroelectric detectors are:

¹ Please note, that a buffer amplifier might be requested in case of very low power OpAmps.

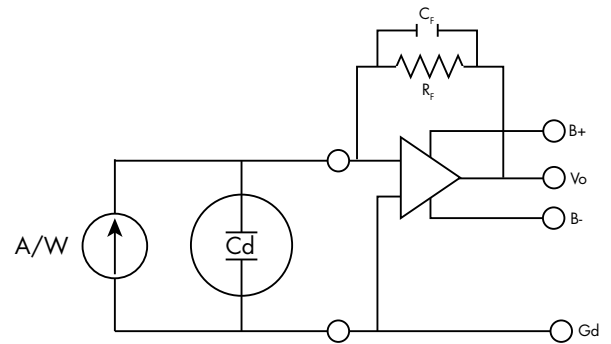

Fig. 7: Typical current mode operational circuit

1. Johnson noise in the load R_L or feedback resistor R_f
2. Current (shot) noise from the input leakage of the integrated JFET or Opamp
3. Voltage noise of the JFET or Opamp
4. Dielectric loss or loss tangent (from the series or parallel resistance associated with the detectors electrodes)

Temperature Fluctuation Compensation (TFC)

There is a common misconception that TFC elements (or “blind”) elements add an active, temperature stabilising solution to a detector; protecting you from drift over slow, long temperature changes. This is unfortunately incorrect. TFC protects against instantaneous changes to the microclimate temperature, and helps to stabilise the active element and reduce the ringing of the signal, bringing the detector back to normal operation.

TFC does reduce the responsivity by a factor of 2 in the voltage mode with parallel compensation. In current mode the signal remains unchanged by TFC. However, TFC in current mode attenuates the tendency toward natural oscillation, thus allowing a larger amplification.

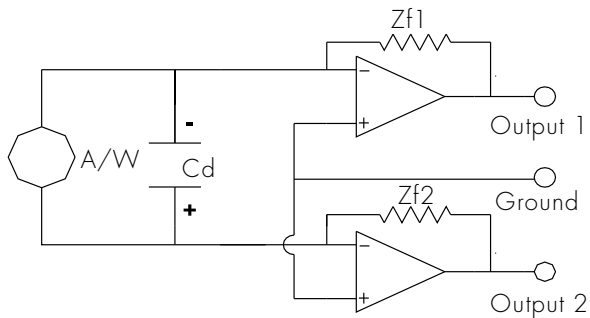

Fig. 8: Circuit diagram of our CM based Differential Pyroelectric Detector

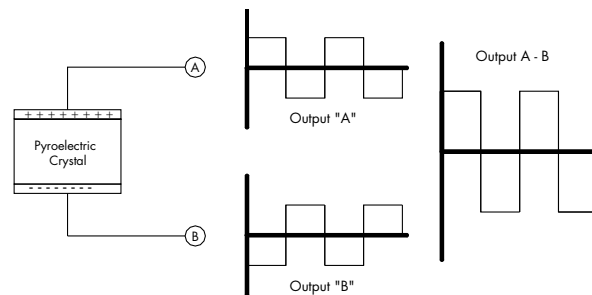

Fig. 9: Demonstration of the effect on signal when both outputs are subtracted.

Differential Pyros

Unlike their thermopile cousins, pyroelectrics are still single-ended detectors; making them susceptible to electromagnetic interference from non-detector related noise. Processor clocks, line interference, and other sources of electromagnetic noise can still be coupled to their output causing unnecessary headaches during design phases of new equipment. LASER COMPONENTS not only has developed a new and unique pyroelectric connection method to eliminate electromagnetic interference, our new, patented detector configuration (Fig.8) improves the signal to noise ratio by approximately 1.4!

When charges are generated on the pyroelectric crystal, both positive and negative charges are generated on opposite sides (Fig. 9). Both sides of the crystal produce opposing signals of equal magnitude, and by using our unique scheme we can subtract the signals from each other (using a differential or instrumentation amplifier) eliminating the common mode noise from outside sources, but effectively doubling the output!

Although our detector signal increases twofold, our noise increases by a factor of only $\sqrt{2}$; **resulting in an overall signal to noise improvement of approximately 1.4.**

In Figure 10 we used one of our differential detectors and introduced common mode noise in the form of a 50Hz signal. As you can see signal 1 and signal 2 both demonstrate the noise; whereas the mathematically subtracted output does not. As well as giving a significantly increased output, the common mode noise has been eliminated.

Because this detector is also based on our Current Mode architecture, our differential detectors can be directly inputted in to modern ADCs and micro-controllers where this subtraction can be done in software; allowing you to cut out pre-amplification stages from your design, and cut down on development costs!

See page 80 for available models.

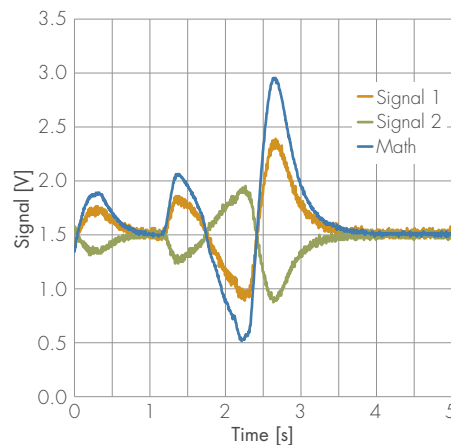

Fig. 10: Common mode noise eliminated via differential detector

Absolute Maximum Ratings

Storage Temperature [°C]		- 25 ... + 85
Operating Temperature [°C]	LiTaO ₃	- 20 ... + 85
	DLaTGS	-20 ... + 55
Soldering Temperature (5 sec.) [°C]		+ 280 ... + 300
ESD Damage Threshold, Human Body Model Class ...* [V]		0 ... <250

* ANSI/ESD STN5. 1-2007

! Handling

ESD sensitive device.

High electrostatic discharge can damage or degrade the device. Use proper EDS handling precautions.



Part Number Designation

Our product nomenclature allows you to see at a glance what's what – details are given below.

Material		Type	Channels	Versions	Mount	Element Size	Filter Code
L	LiTaO ₃	0 chip only	1 single	Version	X standard	1000 Ø 1.0mm	See chapter "Filter and windows for infrared detectors"
LD	LiTaO ₃ differential	1 current mode	2 dual		T TEC	1300 Ø 1.3mm	
D	DLaTGS	2 current mode + TFC	4 quad		D SMD	2000 Ø 2.0mm	
DD	DLaTGS differential	3 voltage mode				3000 Ø 3.0mm	
		4 voltage mode + TFC				1010 1.0 x 1.0mm ²	
						1810 1.8 x 1.0mm ²	
						2020 2.0 x 2.0mm ²	
						3030 3.0 x 3.0mm ²	

Example:

L2410X2020-HGEI

LiTaO₃ - four channel detector in current mode with temp. fluctuation compensation - version 10 (internal use) with standard low micro and 2x2mm² chip size



Editors' Choice

Workhorse

Slow applications

L1130D2020	Extremely rugged single element detector with large field of view. Likes safety applications.	Low temperature dependence
L2100D2020	The universal pyro detector! Single element. Very good performance for money. Likes all kinds of precise measurements.	
L2200D1810	Our standard for single gas detection: a dual detector that likes industrial, environmental and medical applications.	
L2410D2020	Our standard for multi gas detection. A quad channel detector that likes industrial, medical and environmental applications as well as automotive benches.	

Fast applications

D3151X1300	This is the classic detector used for FTIR applications. Status: People call it the gold standard of spectroscopy. Future: We are currently working on a substantial upgrade. However, improving a gold standard is tricky and takes its time. We will keep our customers posted.
D3151X2000	



L11, L21 Series

LTO Single Channel
CM Pyro Detectors

Note

All technical data is prior to window integration

- LiTaO_3
- Single element
- Current mode
- Integrated OpAmp (or JFET)
- TFC optional
- Trend towards low power OpAmp

Basic Characteristics, Specifications

Part Number	Element Size [mm ²]	Aperture Size [mm ²]	Package	TFC	Supply Voltage [V]		Supply Current @1M Ω	Speed
					Max	Recommended		
L1130D2020	2.0 x 2.0	5.0 x 5.0	TO-39 3-pin	n	2.7 – 10	3	–	Low
L2100D2020	2.0 x 2.0	5.0 x 5.0	TO-39 3-pin	y	2.7 – 10	3	30 μ A	Low

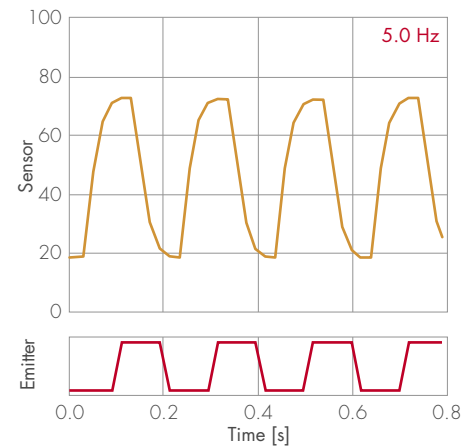
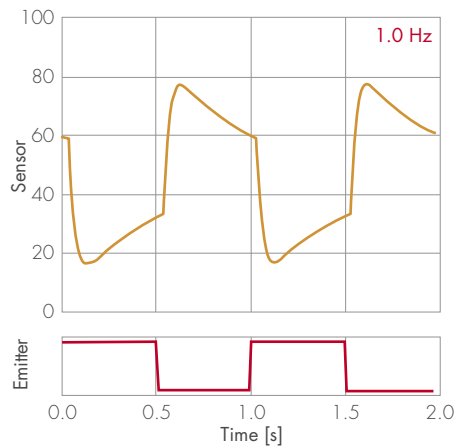
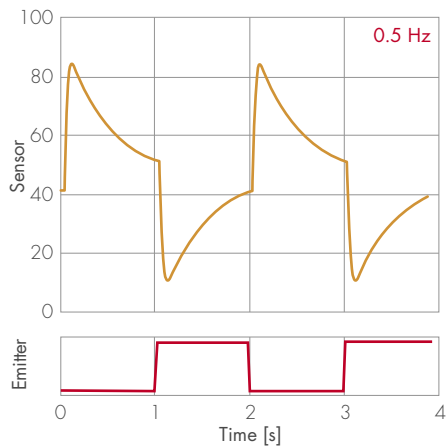

Lithium Tantalate (LiTaO₃/LTO) is the most widely used pyroelectric material in many non-dispersive applications, and as power monitors for pulsed laser systems due to its relatively high performance and low cost compared to other thermal detectors.

Traditionally voltage mode devices have always been used for pyroelectrics; not because of performance, but because of the availability of small and reliable JFETs on the market. Semiconductor manufacturing processes now allows for this with current mode devices providing some distinct advantages over voltage mode, especially for new users.

Figures:
Detector Signal at Different Frequencies
The signal form depends on the frequency of the IR radiation source. Real-time data from our IR applications kit with a single mode CM detector (results vary from model to model).

- Easy system integration
- Short development times
- Increased performance at higher frequencies
- High signal with low offset
- Low temperature dependence
- Low output impedance reduces EMI effects

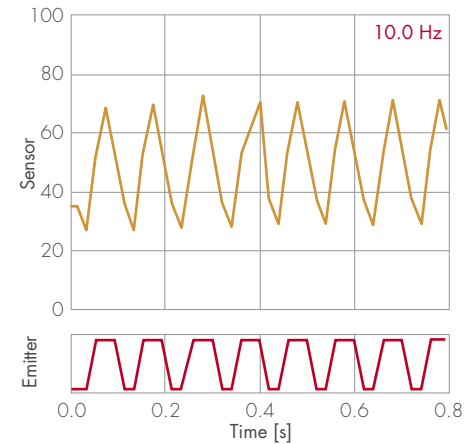

Electro-optical Characteristics

Part Number	Responsivity @500K [V/W, 10Hz]		Max Noise Density [RMS, 10Hz]	D* @ 500K [Jones, 10Hz]		FOV [Deg]
	Min	Typ		Min	Typ	
L1130D2020	6.500	7.500	12 nV	1.50 E+8	2.50 E+8	70
L2100D2020	100.000	150.000	60 μV	4.50 E+8	6.00 E+8	70

LD21 Series

LTO Differential
Single Channel
CM Pyro Detectors

**MORE
MODELS
COMING
SOON !**

- LiTaO_3 Double ended output
- Single element
- Current mode
- Integrated OpAmp
- TFC

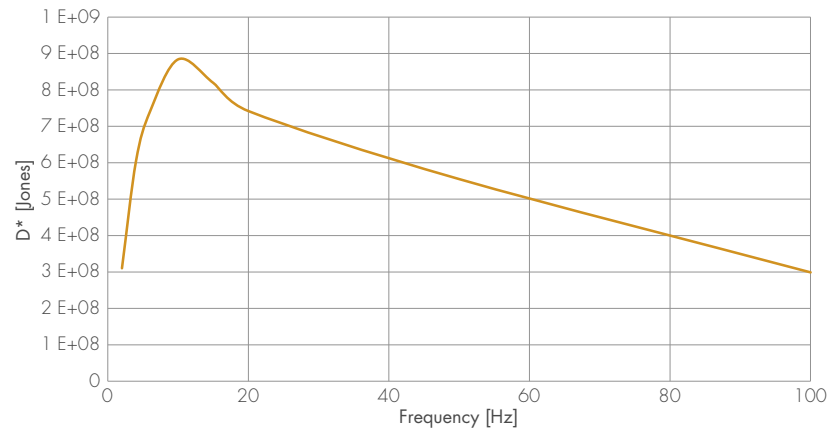

Basic Characteristics, Specifications

Part Number	Element Size [mm ²]	Aperture Size [mm ²]	Package	TFC	Supply Voltage [V]		Supply Current @ 1 MOhm [mA]	Speed
					Max	Recommended		
LD2100X2020	2.0 x 2.0	5.0 x 5.0	TO-39 5-Pin	y	2.7-10	3	1	Low
LD2120X2020	2.0 x 2.0	5.0 x 5.0	TO-39 3-Pin	y	2.8-10	3	3-10	Low

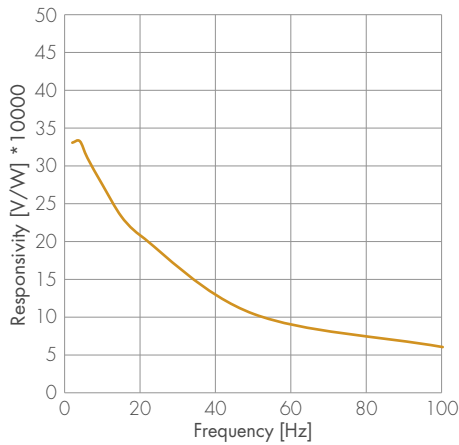
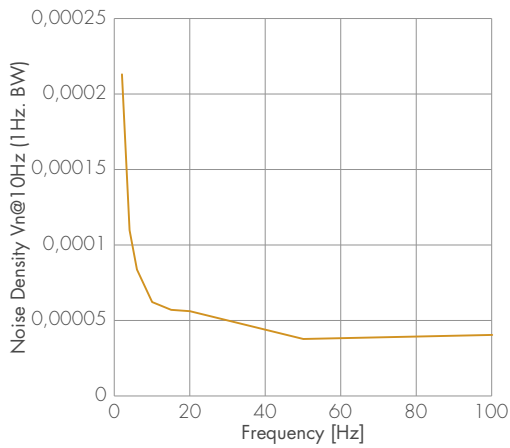

Pyroelectric crystals simultaneously generate positive and negative charges on opposite faces, and our LD2100 detectors exploit this with a new amplification scheme.

The LD2100 series is based on our best-selling L2100 series CM current mode detector, and we plan to bring other differential versions of our detectors to market in due course.

We now can produce a pyroelectric detector that not only gives you double the signal compared to a single ended detector when used with a differential amplifier, but the noise only increases by $\sqrt{2}$. This produces an improvement in signal to noise ratio of around 1.4.

Pyroelectric detectors with a differential amplifier have two additional advantages: External interference signals are eliminated by signal subtraction. Thus, they can be used in critical environments with electric fields. Furthermore, the LD2100 series makes simple wiring possible, by allowing you to connect the signal outputs directly to the inputs of an differential AD converter.

Electro-optical Characteristics

Part Number	Responsivity @500K [V/W, 10Hz, 1 Hz BW]		Max Noise Density [RMS, 10Hz]	D* @ 500K [Jones, 10Hz]		FOV [Deg]
	Min	Typ		Min	Typ	
LD2100X2020	240,000	280,000	70 μ V	8.00 E+08	1.00 E+09	70
LD2120X2020	240,000	280,000	TBD	8.00 E+08	1.00 E+09	80

L1x, L2x Series

LTO Multi Channel
CM Pyro Detectors

- LiTaO_3
- Multi channel elements
- Current mode
- Integrated OpAmp
- TFC optional
- Trend towards low power

Basic Characteristics, Specifications

Part Number	Element Size [mm ²]	Aperture Size [mm ²]	Package	TFC	Supply Voltage [V]		Supply Current @1M Ω	Speed
					Max	Recommended		
L2200D1810	1.8 x 1.0	2.7 x 1.8	TO-39 4-pin	y	2.7 – 10	3	150 μ A	Low
L2410D2020	2.0 x 2.0	Ø 3.5, 4-hole	TO-8 8-pin	y	±16	±5	300 μ A	Low



Multi-channel detectors are most commonly found in gas sensing applications as when combined with narrow bandpass IR filters targeted at specific gas lines; incredibly compact gas sensors can be made based on NDIR detection methods.

Our L1x/2x is available with up to 4 channels with integrated filters, allowing for detection of up to 3 gases simultaneously (3 active channels + 1 reference channel) and any one of our standard filters or custom filters can be fitted.

Current mode devices have a very distinct advantage over voltage mode devices when made into multi-channel detectors. OpAmps when compared to JFETs have a much lower temperature dependence, resulting in a significantly reduced temperature drift between elements when compared to voltage mode operation.

- Available in 2 or 4 channel configurations
- Wide selection of standard filters
- Compact designs
- Greatly improved temperature drift between elements when compared to voltage mode

Electro-optical Characteristics

Part Number	Responsivity @ 500K [V/W, 10Hz]		Max Noise Density [RMS, 10Hz, 1 Hz BW]	D* @ 500K [Jones, 10Hz]		FOV [Deg]
	Min	Typ		Min	Typ	
L2200D1810	60,000	120,000	50 μ V	3.00 E+08	5.00 E+08	20°
L2410D2020	90,000	120,000	65 μ V	6.00 E+08	7.50 E+08	45

° wider available

D31 Series

DLaTGS Single Channel
VM Pyro Detectors



- DLaTGS
- Single element
- Voltage mode
- Integrated JFET
- Also available as TEC version

Basic Characteristics, Specifications

Part Number	Element Size [mm]	Aperture Size [mm]	Package	TFC	Supply Voltage [V]		Speed
					Max	Recommended	
D3151X1300	Ø 1.3	Ø 5.3	TO39 4-pin	n	25	9	High
D3151X2000	Ø 2.0	Ø 5.3	TO39 4-pin	n	25	9	High

Our D31 series of Voltage Mode DLaTGS detectors are aimed at legacy customers who use DLaTGS or TGS in existing FTIR applications and devices, it is recommended that new developments take advantage of our selection of differential current mode, or differential voltage mode devices.

DLaTGS (deuterated L-alanine-doped triglycine sulphate) has some advantages over TGS, mainly the increased Curie temperature of 61°C (10K higher). This is achieved via. the process of deuteration, the complete replacement of all hydrogen atoms by deuterium atoms.

Additional doping increases the sensitivity of detectors and prevents permanent depolarisation when heating beyond the Curie temperature.

- Improved Curie temperature when compared to TGS
- DLaTGS D* typically 2.5 times higher than LTO
- TEC available for elevated temperature operation
- No permanent depolarization
- Ideal for existing FTIR designs
- Many well-known configurations available

Electro-optical Characteristics

Part Number	Responsivity [V/W, 1 kHz, 1000K]	D* [Jones, 1 kHz, 1000K]		NEP [W/√Hz]	FOV [Deg]
	Typ	Min	Typ		
D3151X1300	60	2.00 E+08	2.70 E+08	4.50 E-10	40
D3151X2000	30	2.10 E+08	2.80 E+08	6.00 E-10	35

Filters and Windows

for infrared detectors

The pyroelectric detector configuration is concluded with an appropriate window or filter specification.

Depending on the application, the filter/window defines the spectral sensitivity of the pyroelectric element, also providing a reliable hermetic sealing of the optical interface between the detector and its environment.

The detector designation includes the filter/window description via codes according to the following tables.

Numbers are used for filters (see table 1, page 86) for applications that require a large aperture/field of view e.g. flame detection. Here the detector aperture is normally $5 \times 5 \text{ mm}^2$ for single channel detectors.

Letters are used for filters in applications where a small aperture is sufficient. Here the aperture is $3.5 \times 3.5 \text{ mm}^2$ (for single elements in TO-39 can).¹

For the windows (see table 2 on page 88) in general the aperture is $5 \times 5 \text{ mm}^2$ for single channel detectors. However other apertures are available on request.

■ Please note that if pyroelectric detectors are required without any filter or ● window, we cannot offer any warranty on the functionality of the device.

¹ The small aperture is the standard option for narrow bandpass filters. A larger aperture gives more signal; However, selectivity might be compromised due to angular shifts and instrument calibration may become more difficult.



General Specifications

Thickness	0.4–0.7 mm
Blocking	Up to 10 μm , for CWL > 6 μm : up to 13 μm
Surface Quality	MIL-F-48616
Environmental quality	acc. to MIL-F-48616 (Temperature §4.6.9.1, Humidity §4.6.8.2, Moderate abrasion §4.6.8.3, Adhesion §4.6.8.1, Solubility and Cleanability §4.6.9)



Table 1: Standard Gas Sensor Filters

	Code*	Application	CWL [µm]	HPBW [µm]	Spectral shift @ AOI 15° [nm]	Temperature shift [nm/K]
NBP 3.33–160nm	C 35	CH ₄	3.33 ± 20nm	160 ± 20nm	≤ -20	< +0.50
NBP 3.40–120nm	G 40	HC	3.40 ± 30nm	120 ± 20nm	≤ -25	< +0.25
NBP 3.70–110nm	P 48	Reference for medical CO ₂	3.70 ± 35nm	110 ± 30nm	≤ -30	< +0.50
NBP 3.86–90nm	B 41	Reference for SO ₂ mixtures	3.86 ± 30nm	90 ± 20nm	≤ -20	< +0.50
NBP 3.95–90nm	H 34	Reference	3.95 ± 35nm	90 ± 10nm	≤ -15	< +0.50
NBP 4.26–90nm	T 32	CO ₂ narrow	4.26 ± 20nm	90 ± 20nm	≤ -20	< +0.50
NBP 4.265–110nm	A 42	CO ₂ easy calibration	4.265 ± 20nm	110 ± 20nm	≤ -20	< +0.50
NBP 4.26–180nm	D 33	CO ₂	4.26 ± 20nm	180 ± 20nm	≤ -40	< +0.25
NBP 4.27–170nm	Z 43	CO ₂ standard	4.27 ± 30nm	170 ± 20nm	≤ -20	< +0.50
BP 4.30–600nm	F 30	flame	4.30 ± 50nm	600 ± 50nm	≤ -20	< +0.50
NBP 4.45–60nm	E 44	CO ₂ long path	4.45 ± 20nm	60 ± 20nm	≤ -20	< +0.50
NBP 4.66–180nm	I 39	CO centered	4.66 ± 30nm	180 ± 20nm	≤ -20	< +0.50
NBP 4.74–140nm	K 37	CO flank	4.74 ± 20nm	140 ± 20nm	≤ -20	< +0.50
NBP 5.3–180nm	L 31	NO	5.3 ± 40nm	180 ± 20nm	≤ -25	< +0.60
NBP 5.78–180nm	M 38	H ₂ O in gas mixtures	5.78 ± 40nm	180 ± 20nm	≤ -22	< +0.60
NBP 6.22–110nm	V 47	NO ₂	6.22 ± 30nm	110 ± 20nm	< 20	< +0.80
NBP 7.3–200nm	U 45	SO ₂	7.3 ± 40nm	200 ± 30nm	≤ -30	< +0.80
NBP 7.91–160nm	S 46	CH ₄ in gas mixtures	7.91 ± 50nm	160 ± 30nm	≤ -30	< +0.80
BP 9.50–450nm	O 36	Alcohol	9.50 ± 60nm	450 ± 60nm	≤ -40	< +1.00

NEW

* Letter for small aperture / Number for large aperture

Note: For gas measurement applications the small aperture is standard due to selectivity.

Large aperture is standard in flame applications.

Bandpass Filters for Detection of Methane, HC and References

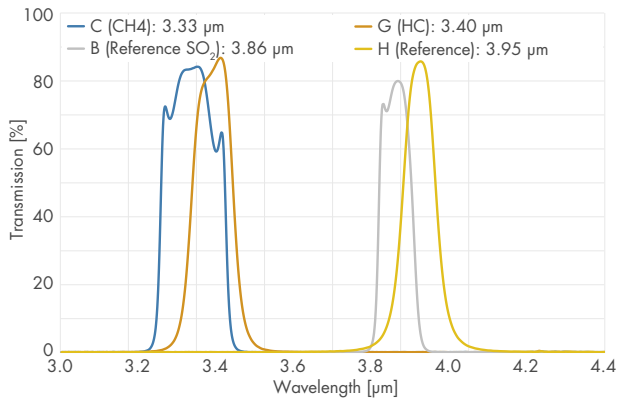

Bandpass Filters for Detection of CO₂

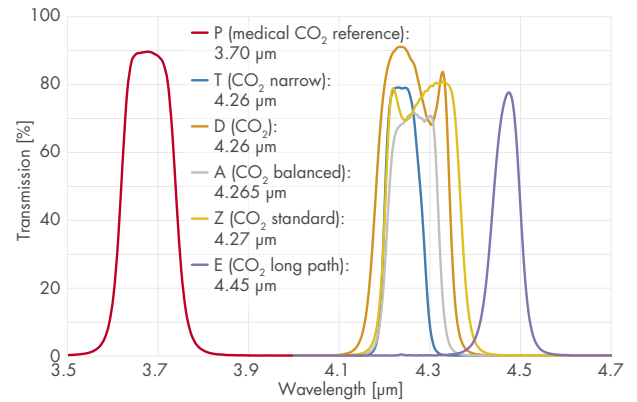

Bandpass Filter for Flame Detection

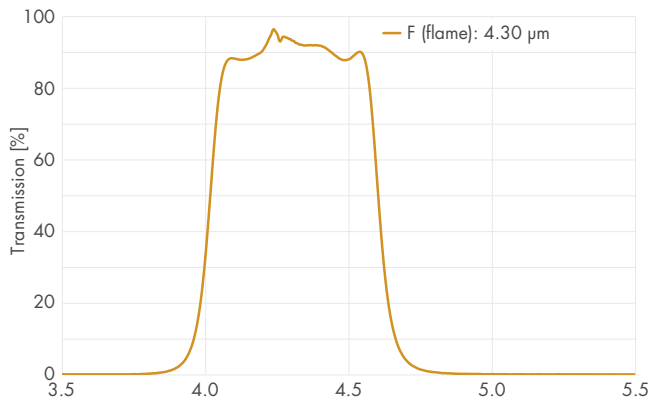

Bandpass Filters for Detection of CO, NO and H₂O

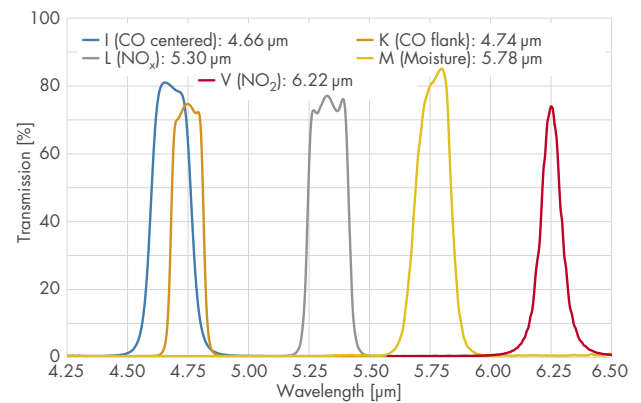

Bandpass Filters for Detection of SO₂ and Methane in Gas Mixtures

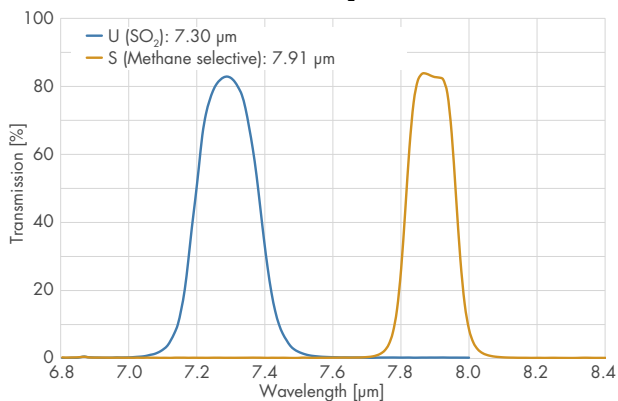

Bandpass Filter for Detection of Alcohol

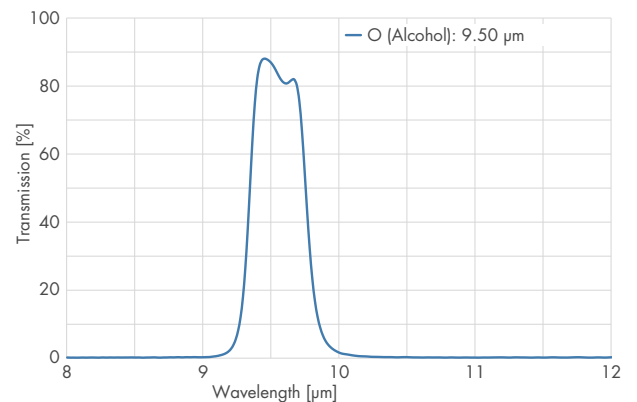

Table 2: Standard Windows

Code	Transmission Range/Coating Range [μm]	Description	Thickness [mm]	Notes
b1	UV-15	BaF ₂ -Barium Fluoride	0.4	
c1	UV-12	CaF ₂ -Calcium Fluoride	0.4	
k1	UV-25	KBr-Potassium Bromide, protected	1.0	
k2	UV-25	KBr-Potassium Bromide, uncoated	1.0	Water-soluble
l1	7.5-15	Si LWP-Silicon longwave-pass filter	0.55	Cut on (5%) ~ 7.22 μm 50% point ~ 7.5 μm
s1	2-56	Silicon uncoated	0.5	for far IR (THz) applications
s2	3-5	Silicon A/R-coated	0.9	
s3	3-6	Silicon A/R-coated	0.5	T (4.7 + 5.3 μm) > 99%
w1	8-14	Silicon bandpass filter	0.55	T _{ave} (9-13 μm) > 75%
z1	2-14	Zinc Selenide AR-coated, wedged	1.0	
z2	0.6-16	Zinc Selenide wedged	1.0	

Available Options

Code	Transmission Range/Coating Range [μm]	Description	Thickness [mm]	Notes
a1	UV-5	Sapphire uncoated	0.4	
d1	UV-100	CVD Diamond	0.15	
i1	UV-50	CsI-Caesium iodide	1.0	Water-soluble
p1		HDPE: High density polyethylene	0.8	for far IR (THz) applications
Y		without window		No warranty

Example:

LT.....b1: Detector with Barium Fluoride window, 0.4 mm thick.

Notes: Transmission ranges are typical values and are not specified as this is a material property.

Highlighted versions are off-the shelf standards.

Barium fluoride BaF₂ and Calcium fluoride CaF₂

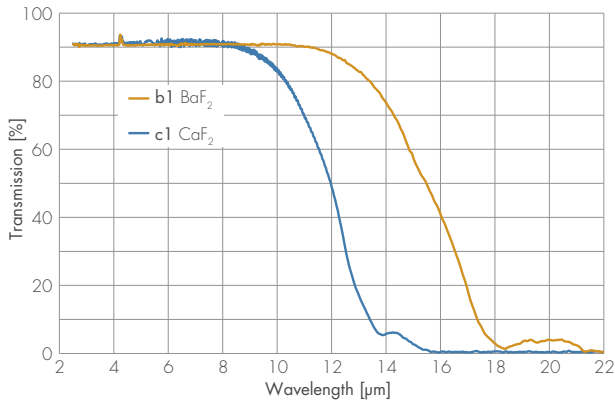

Potassium bromide, protected and uncoated

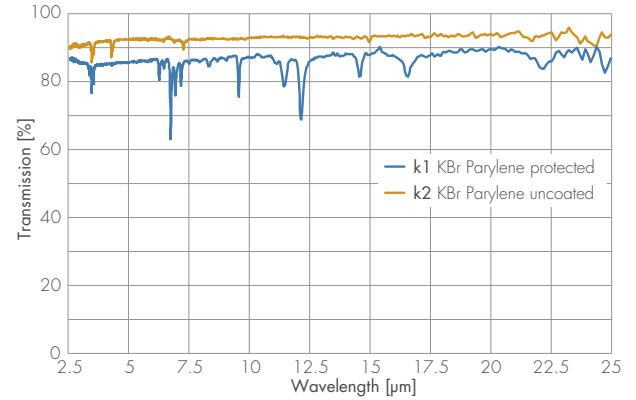

Silicon uncoated

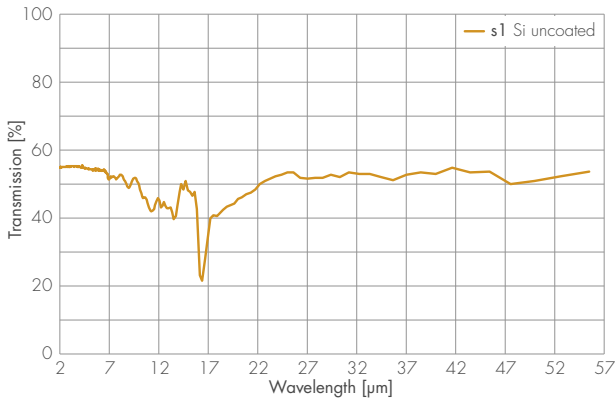

Silicon bandpass filter

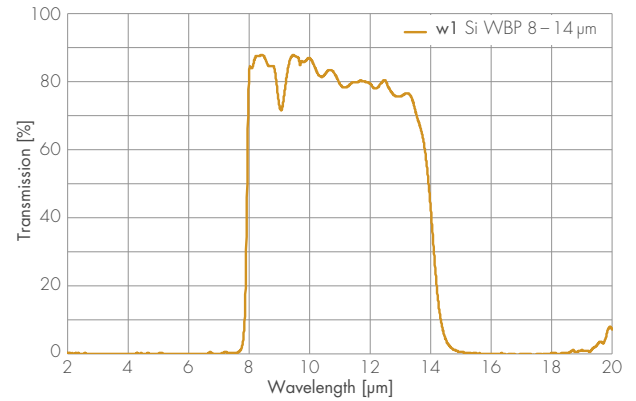

Zinc Selenide uncoated / AR-coated

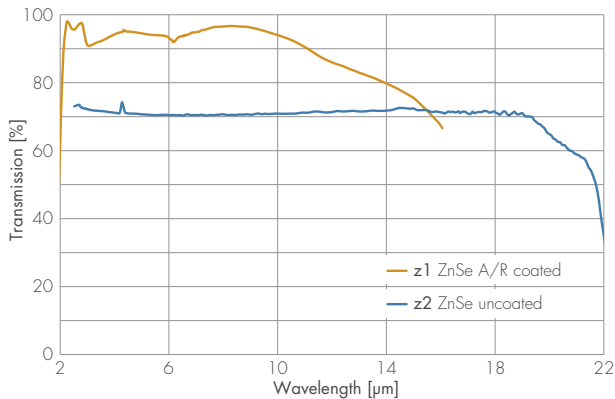

Silicon longwave-pass filter / Silicon coated

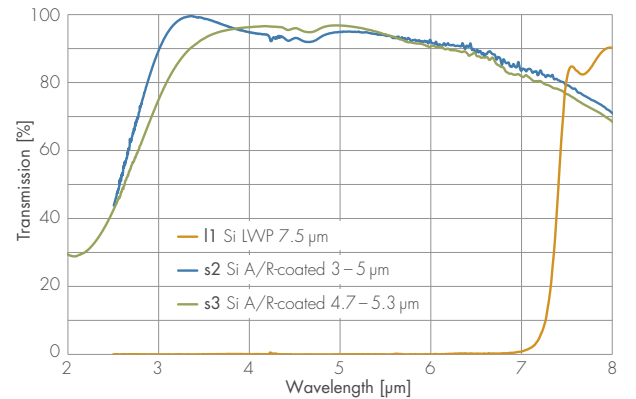

Packaging

- 1 TO-39 small aperture $3.5 \times 3.5 \text{ mm}^2$
- 2 TO-39 large aperture $5 \times 5 \text{ mm}^2$
- 3 TO-39 Dual channel
- 4 TO-39 round aperture
- 5 TO-8 4 channel large aperture

See datasheet for all versions and exact dimensions.



Specials



info@lasercomponents.com

You can also give us a call!

Germany | Worldwide +49 8142 28640

USA +1 603 821 7040

France +33 1 3959 5225

UK +44 1245 491499

Nordic Countries +46 31 703 7173





IR Emitters



info@lasercomponents.com

You can also give us a call!

Germany|Worldwide+49 8142 28640

USA +1 603 821 7040

France +33 1 3959 5225

UK +44 1245 491499

Nordic Countries +46 31 703 7173



Model	Pk Volts	Pk Current [A]	Pk Power [W]	Window
Pulsable/Steady State Tungsten Filament Source (TO-8)				
EP-3872	2.20	1.10	2.40	Sapphire
EP-3962	2.60	1.05	2.70	Sapphire
EP-3963	3.00	1.00	3.00	Sapphire
EP-3964	3.50	1.00	3.50	Sapphire
EP-3965	3.50	2.00	7.20	Sapphire
EP-4317	5.00	2.10	10.50	Sapphire

Pulsable/Steady State NiCr Filament Source (TO-8)				
EF-852X*	2.00	1.30	2.60	■
EF-853X*	3.00	1.30	4.40	■

Steady State Kanthal Filament Source (TO-8)				
EK-827X	1.20	1.08	1.30	■
EK-837X	1.40	1.75	2.45	■
EK-852X	3.00	1.48	4.40	■
EK-862X	3.50	2.40	8.40	■

Steady State Kanthal Filament Source (TO-3)				
EK-343X	4.00	2.96	11.84	■

Steady State Kanthal Filament Source (TO-5 = TO-39)				
EK-527X	1.20	1.08	1.30	■
EK-537X	1.40	1.75	2.45	■

Notes: Shortened "Point Source" filaments are available for all EK-style IR sources
Custom IR sources are available upon request

* Add an "R" to include Reflector

Window Options

■ = X	0	1	2	3
	No Window	Sapphire: 0.3–5µm	CaF ₂ : 0.3–9µm	ZnSe: 0.6–16µm



Thermal Emitters

HelioWorks manufactures a wide range of black body infrared emitters primarily for the OEM market. Our products are used in near infrared (NIR) spectroscopy, non-dispersive infrared (NDIR) gas detectors for medical and industrial applications including: CO, CO₂, alcohol, hydrocarbon and other noxious gases, and many other applications.

EK Series - Steady State Emitters

- Operating temperatures 900 °C ... 1050 °C
- Kanthal Filament with Emissivity of 0.7
- Various window options available
- Internal Gold Plated Parabolic Reflector
- Industry Standard TO Package
- Inert Gas Backfill



Infrared Radiation

The infrared spectrum is invisible and starts at approx. 800nm. It is divided as follows:

- near infrared (NIR) 750–1400 nm
- short-wavelength IR (SWIR) 1400–3000 nm
- mid-infrared (MIR) 3000–8000 nm
- long-wavelength IR (LWIR) 8–15 μm
- far infrared (FIR) starts at 15 μm

Thermal emitters can be approximated as black body emitters with varying emissivities based on the material used.

EP Series - Pulsable Emitters

- Operating temperatures up to 1700 °C
- Tungsten Filament
- Sapphire Window
- Operates in Pulsed or Steady State Mode
- Internal Gold Plated Parabolic Reflector
- Industry Standard TO-8 Package



Types of IR Emitters

There are two general types of IR Emitters: pulsable sources and steady state elements.

EF Series - Pulsable Emitters

- Operating temperatures up to 700 °C
- Filament has uniform emitting area
- Emissivity is 0.88
- Various window options available
- Operates in Pulsed or Steady State Mode
- Industry Standard TO-8 Package
- NiCr Filament
- Large temperature change, ΔT , during pulsing

HQE Detectors

Features

- Quantum efficiency $\geq 99\%$ (99.5% typically)
- Screened for microdefects
- Delivered with removable cap
- Anode and cathode isolated from ground
- For 1064 + 1550nm

Our High Quantum Efficiency (HQE) photodiodes have been provided to a number of research organizations around the world. Customers have achieved record breaking results especially in squeezed light applications. These photodiodes are typically tailored to a specific wavelength, angle of incidence and polarization.

Specifications, Typical Values

Part Number	Diameter [μm]	Dark Current @-2,5V	Capacity @-2,5V, 1MHz	Bandwidth	Responsivity [A/W]
IGHQEX0060	60	100 pA	500 fF	1.5 GHz	1.14
IGHQEX0080	80	200 pA	1 pF	800 MHz	1.14
IGHQEX0100	100	300 pA	2 pF	400 MHz	1.14
IGHQEX0300	300	500 pA	8 pF	100 MHz	1.14
IGHQEX0500	500	800 pA	14 pF	35 MHz	1.14
IGHQEX2000	2000	25 nA	180 pF	500 kHz	1.14
IGHQEX3000	3000	60 nA	400 pF	350 kHz	1.14

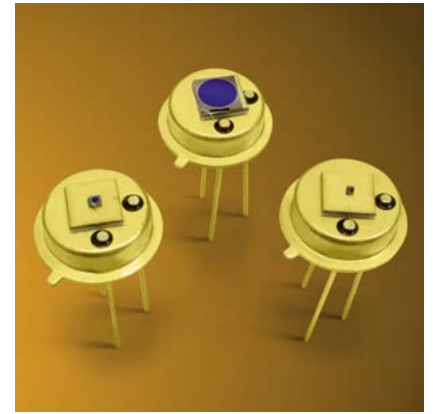
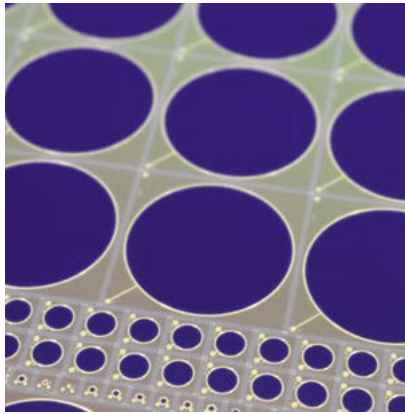

Maximum Ratings

Max Forward Current	10mA
Max Reverse Voltage	-1.5V
Operating Temperature	-20 .. 85°C

Typical AR-Coatings (R < 0.4%, R < 0.05% best effort)

Wavelength: 1064 nm
 AOI: 20°
 s-Polarization (TE)

Wavelength: 1064 nm
 AOI: 10°
 p-Polarization (TM)

Wavelength: 1550 nm
 AOI: 20°
 s-Polarization (TE)

other AR coatings possible

IR Filters



info@lasercomponents.com

You can also give us a call!

Germany|Worldwide+49 8142 28640

USA +1 603 821 7040

France +33 1 3959 5225

UK +44 1245 491499

Nordic Countries +46 31 703 7173

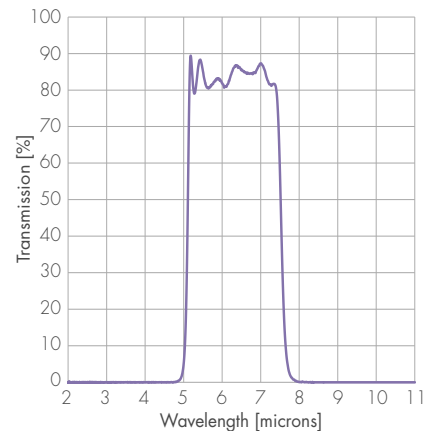
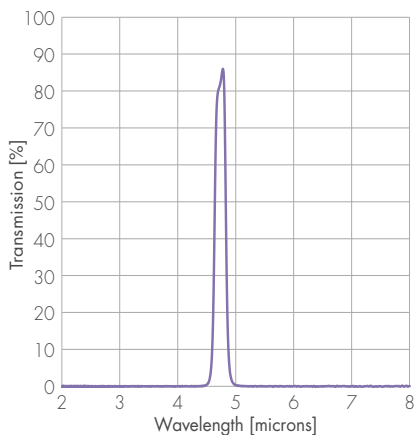

Narrow Bandpass Filters are designed to isolate a narrow region of the infra-red spectrum. This is accomplished using a complex process of constructive and destructive interference. Narrow band pass filters have bandwidths (measured at half-peak transmittance levels) less than 6% of the centre of wavelength value. When ordering, the bandwidth can be expressed as a percentage of the centre wavelength, or can be given in microns. The filters exhibit high peak transmission (typically greater than 60%) combined with high attenuation levels outside the passband (typically less than 0.1%).

This **Wide Bandpass Filter** highlights NOC's ability to create high wavelength filters while still maintaining the steep slopes and flat top that are becoming ever more important in the industry.

The filters exhibit high average transmission in the passband (typically greater than 70%) and very low transmission levels outside the passband (typically less than 0.1%). This type of filter is particularly useful for isolating the 3–5 μm or 8–12 μm atmospheric windows and finds widespread use in thermal imaging/human body sensor applications.

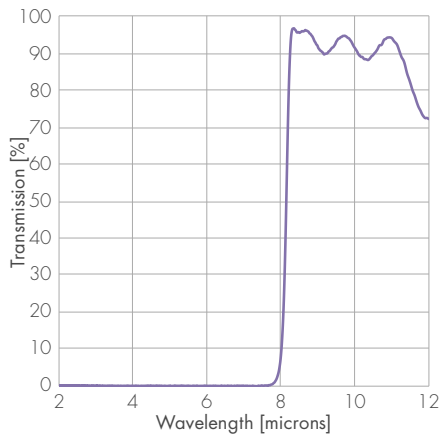

Long Wave Pass Filters (also referred to as edge filters) are constructed from stacks of thin layers. They are distinguished by a sharp transition from a zone of rejection to a zone of transmission. The rejection region extends to below $0.3\mu\text{m}$ and the transmission region typically extends to greater than twice the wavelength of the edge position.

IR Semiconductor Filters

These are not strictly speaking thin film filters but are based on the band structure of the semiconductors. The material is AR coated + polished and available in Si, GaAs, Ge or InAs.

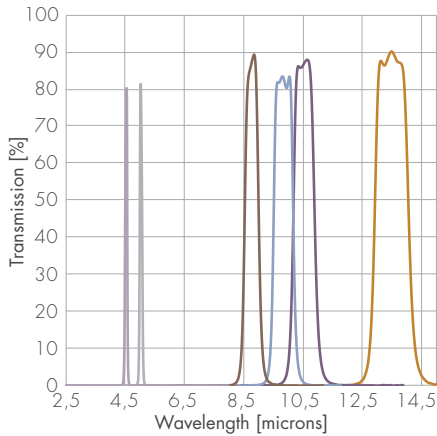

Specials. A range of special purpose narrow band filters for gas and vapour analysis are generally available ex-stock at very competitive prices. Specifications are based on general customer requirements and experience over many years, although tighter tolerances, different bandwidths and filters for other gas bands are available on request.

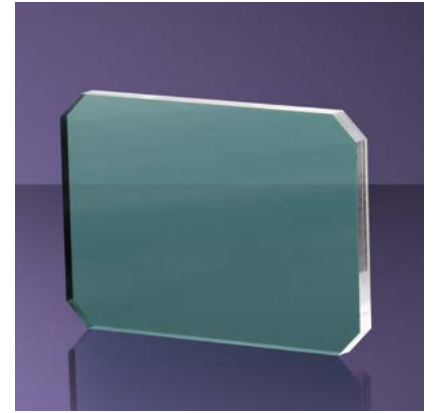

Beamsplitter $4.74\mu\text{m}$ at AOI 45°

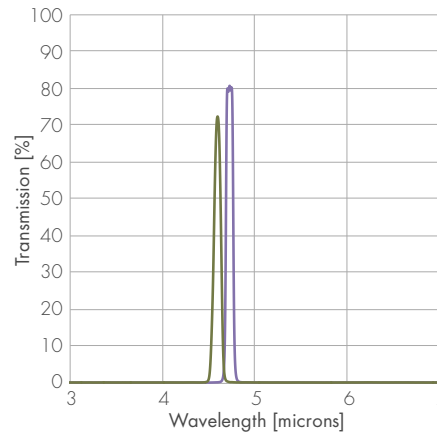

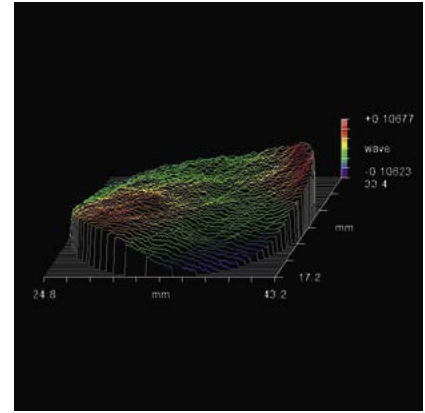
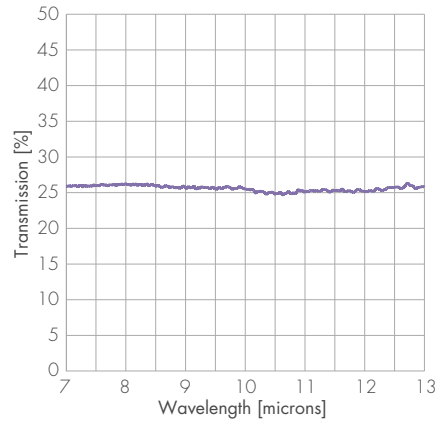
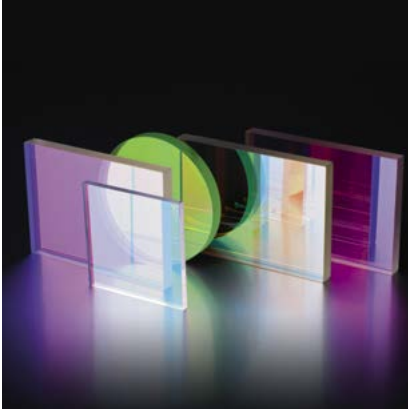

IR Neutral Density Filters

Neutral IR gray filters are used for the broadband attenuation of infrared radiation, and are largely produced according to customer specifications. A metallic coating is responsible for the attenuation of light via reflection or absorption.

Depending on the required wavelength range (up to 14 μm), substrates such as fused silica, sapphire, germanium, or silicon are used. IR ND filters are classified by optical density (OD) in the range from 0.1 to 2.0, and shape of the curve across the wavelength range can be considered as linear.

Low Stress Manufacturing Process

When a thin-film hard coating is deposited onto a substrate, the stress of the coating causes the substrate to bend. This coating stress induced curvature can result in image distortion. Traditionally, this curvature can be minimized by the use of a thicker substrate or by a backside compensation coating. However, both of these options come with drawbacks. Therefore, Alluxa has developed a low-stress manufacturing process that produces ultra-flat dichroics and mirrors without the need for backside compensation. The dichroic filter in the figure above refers to another dichroic which is identical in terms of spectral response, coating thickness, and both substrate thickness and material. However, the filter produced using the low-stress process is flatter by nearly one order of magnitude than the filter manufactured using standard methods.

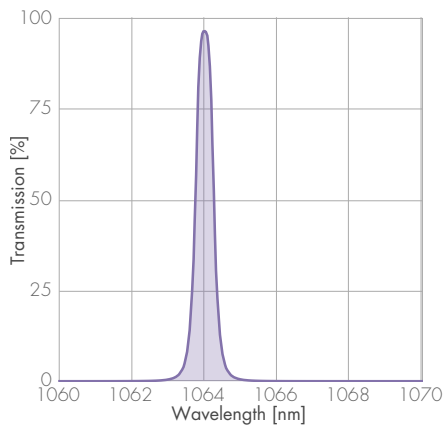

■ 1064-0.5 OD6 Ultra Narrow Bandpass

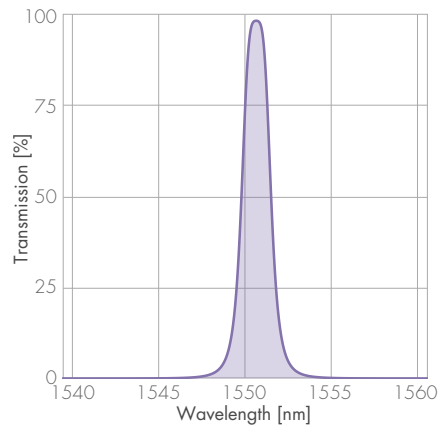

■ 1550.6-1.8 OD4 Ultra Narrow Bandpass

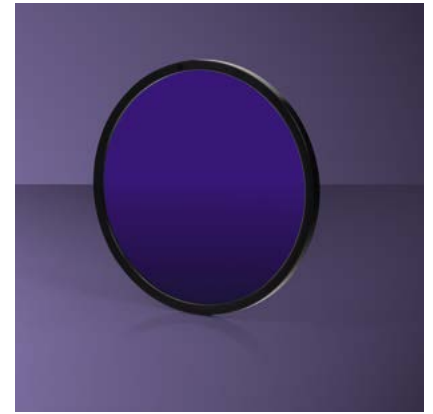

Ultra Narrow Bandpass Filters are ideal for use as laser line, laser cleanup, or laser excitation filters in applications such as fluorescence microscopy, flow cytometry, and DNA sequencing. Alluxa is the only manufacturer offering FWHM bandwidths as narrow as 0.1 nm

- Up to >98% peak transmission
- Fully blocked out of band range up to OD10 by design
- Multicavity designs for square spectral performance
- CWL tolerances as tight as 0.05 nm or less
- Transmitted Wavefront Error (TWE) as low as 0.01 wave RMS/inch (measured at 632.8 nm)

Ultra Narrow NIR Filters for Communication

- Highest peak transmission >90% (95% typical between 1000 nm and 2000 nm)
- Fully blocked - OD3, OD4, or OD6 from 200 nm to 2000 nm (30 dB to 60 dB)
- 'Squarest' passbands in the industry
- 2, 3, 5, 7+ cavity filters
- Specializing in large formats
Diameters up to 300 mm



Special
Partner



Company Brief: Alluxa, Inc.

Founded in 2007

Located in Santa Rosa, California, USA

Alluxa is a rapidly growing manufacturer of dielectric filters with traditional focus on wavelengths from 0.25 μm to 2 μm .

Inhouse Processes

- Thin film coating, glass coring and singulation
- Design and fabrication of thin-film coating equipment

Philosophy

- Every job can be handled by all of the coaters
- Custom solutions to the most challenging optical coating problems at competitive pricing
- Major investments into measurement tools
- Automation whenever it gives an advantage
- 24-7 production

Milestones

- ISO 9001 accreditation in 2008
- Sales agreement with LASER COMPONENTS GmbH in 2015
- Time Zone: Pacific Time



Company Brief: Northumbria Optical Coatings Limited

Founded in 1994

Located in Boldon, United Kingdom

NOC is supplier of dielectric filters in the wavelength range from $\sim 2\mu\text{m}$ to $20\mu\text{m}$.

- In-house Processes:
Thin film coating, polishing and cutting of optical materials and metrology
- First product shipped:
Narrow Band Filter, CWL $4.62\mu\text{m}$ on a Germanium substrate

Milestones:

- Doubling of floorspace in 2003 and again in 2013 to 10.000 sqft
- ISO accreditation September 2006
- Acquisition of FK Optical in 2011
- Establishment of Polishing and Cutting Departments in 2013
- State-of-the-art cutting capabilities from 2014
- 2015 – Investment into new test equipment for the metrology department (Zygo Interferometer)
- 2016 / 2017 / 2019 – Coating machine upgrades

- Time zone: Greenwich Mean Time





Special
Partner

Company Brief: Helioworks, Inc.

Founded in 2003

Located in Santa Rosa, California, USA

Helioworks, Inc. is manufacturer of pulsed and steady state infrared lamps.

- In-house Materials: Tungsten, Kanthal and NiCr
- First product: Steady state Kanthal based emitter (2003)

Milestones:

- Patent on tungsten filaments was granted on 17th October 2006
- Time zone: Pacific Time

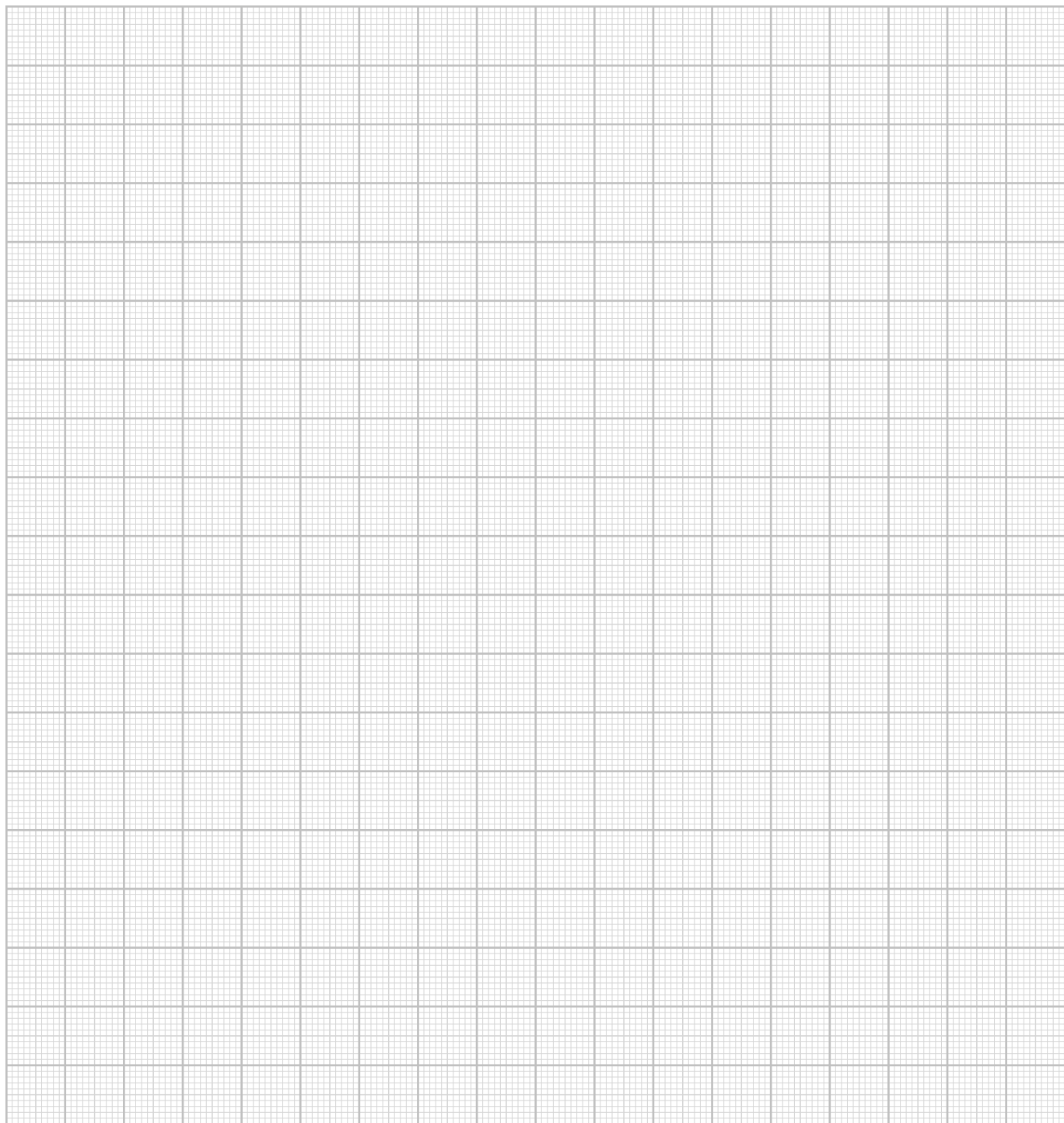

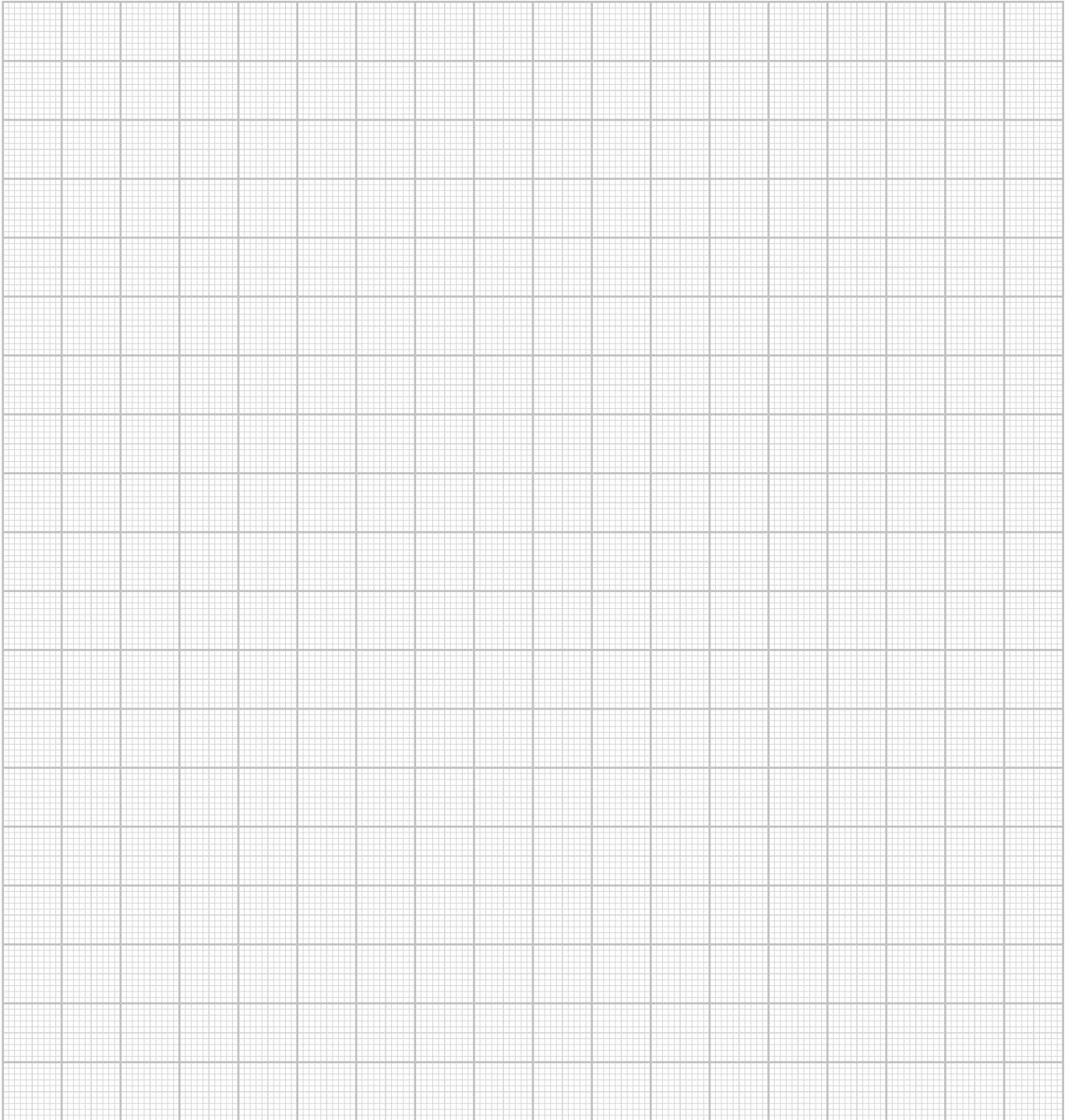

Product Changes

LASER COMPONENTS reserves the right to make changes to the product(s) or information contained herein without notice. No liability is assumed as a result of their use or application.

Ordering Information

Products can be ordered directly from LASER COMPONENTS or its representatives. For a complete listing of representatives, visit our website at www.lasercomponents.com



Editor

LASER COMPONENTS GmbH
Werner-von-Siemens-Str. 15
82140 Olching/Germany

Tel: +49 8142 2864-0
Fax: +49 8142 2864-11
www.lasercomponents.com
info@lasercomponents.com

General Managers: Patrick Paul
Commercial Register in Munich HRB 77055

Print: flyeralarm, Würzburg



Copyright

This catalog, including all written and visual entries, is protected by copyright. With the exception of specific cases permitted by law, use of this material without the consent of Laser Components GmbH is punishable by law.

Despite thorough research, LASER COMPONENTS GmbH will not accept responsibility for any inaccuracy of content. Technical material is subject to change without notice.

Worldmap on backcover: © [istock.com/dikobraziy](https://www.istock.com/dikobraziy)

© 2020. All Rights reserved.

V7; 07/20 3030783



CONTACT

Germany & Worldwide Contact LASER COMPONENTS GmbH

Werner-von-Siemens-Str. 15
82140 Olching / Germany

Tel.: +49 8142 2864-0
info@lasercomponents.com
www.lasercomponents.com

France LASER COMPONENTS S.A.S.

45 Bis Route des Gardes
92190 Meudon / France

Tel.: +33 1 3959 5225
info@lasercomponents.fr
www.lasercomponents.fr

Nordic Countries LASER COMPONENTS Nordic AB

Skårs led 3
41263 Göteborg / Sweden

Tel.: +46 31 703 71 73
info@lasercomponents.se
www.lasercomponents.se

USA LASER COMPONENTS USA, Inc.

116 South River Road
Bedford, NH 03110 / USA

Tel: +1 603 821 7040
info@laser-components.com
www.laser-components.com

Great Britain LASER COMPONENTS (UK) Ltd.

Goldlay House 114 Parkway
Chelmsford Essex CM2 7PR / UK

Tel: +44 1245 491 499
info@lasercomponents.co.uk
www.lasercomponents.co.uk

