

AN-109

Verifying Continuity with fiberMAP

Overview

OPL-MAX has a built in sequence to test continuity for multi-fiber cables. The only requirement is that the user has a multichannel source and a multichannel power meter.

Startup

Navigate to the OPL-Max software shortcut located either in the Start menu or on the desktop. When the splash screen appears, select the proper setup via the Selected Setup dropdown menu.

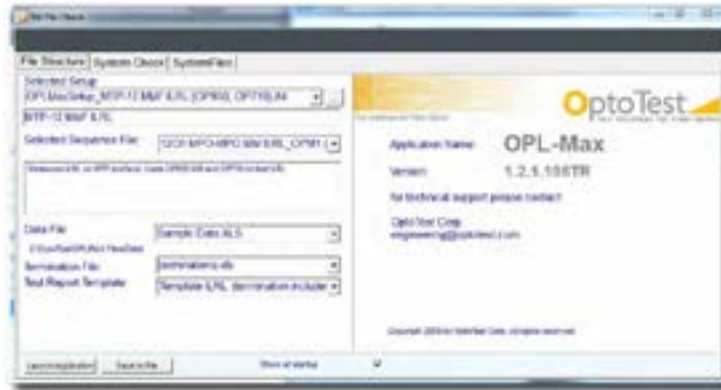

Figure 1: OPL-Max splash screen

If either the multichannel source or the multichannel power meters are not connected, the software will give an error message and the software must be restarted when both units are connected.



Figure 2: Error message



Figure 3: Default Sequence tab

With the multichannel units properly connected, the software will open with the correct setup and sequence on the Setup > Sequence (default) tab.

Doc: AN-109 Rev. A 5/17/13

Verifying Continuity with FiberMAP

AN-109

The user can verify the correct units are being recognized as well as their ID. This can be viewed in Setup > Instruments.

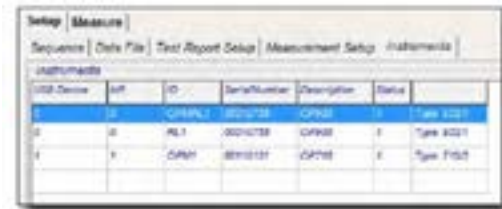

Figure 4: Instruments tab in setup

Navigate back to the Sequence tab and click on fiberMAP on the top right. A popup screen should appear showing a matrix of inputs versus outputs.

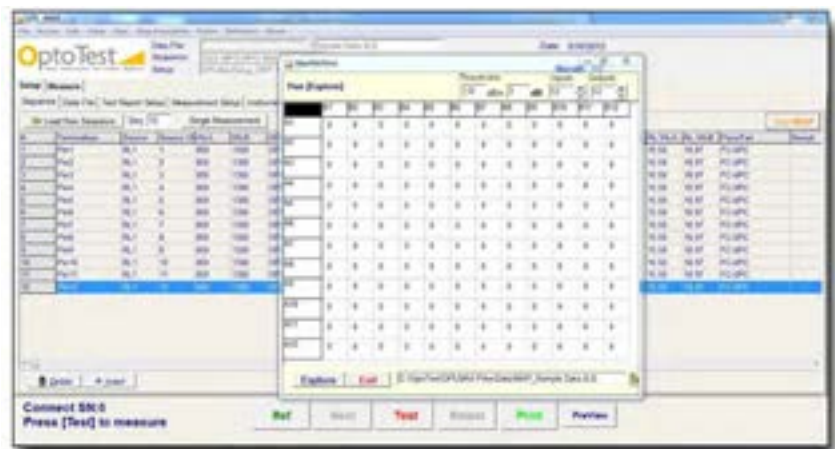

Figure 5: Popup showing a matrix of inputs versus outputs

Setup

Before running the fiberMap one needs to configure the setup.

Threshold

The dBm threshold value is the minimum power level which will be considered a "lit" channel. The relative dB value creates a range of accepted measurements that indicate a fiber is connected.

Inputs

This is the number of inputs channels from the source. For a 12 fiber MPO cable this value would be 12.

Outputs

This is the number of output channels to be monitored.

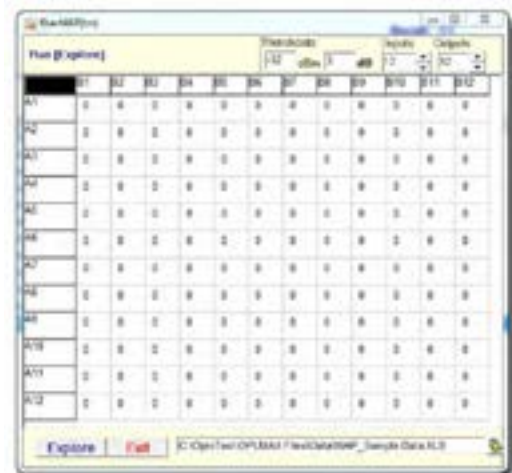

Figure 6: FiberMap setup configuration

Doc: AN-109 Rev. A 5/17/13

Verifying Continuity with FiberMAP

AN-109

Simulation

When setup is complete, click Explore. The software will run through all outputs per input and read the power levels.

Figure 7: Simulation of hardware setup for verifying continuity with FiberMAP

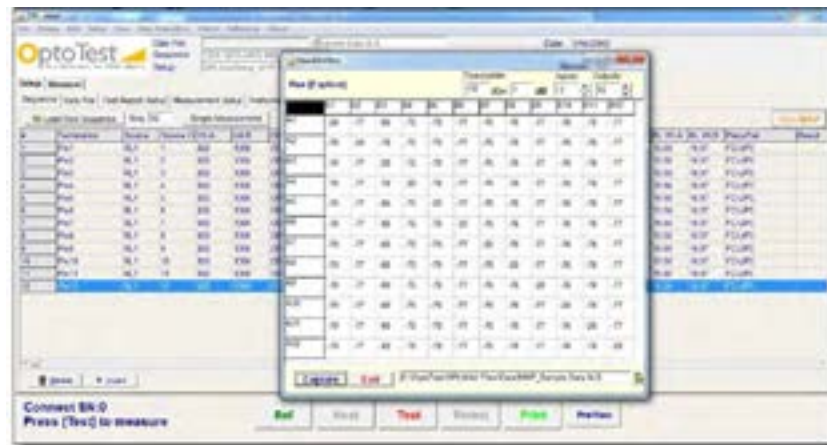
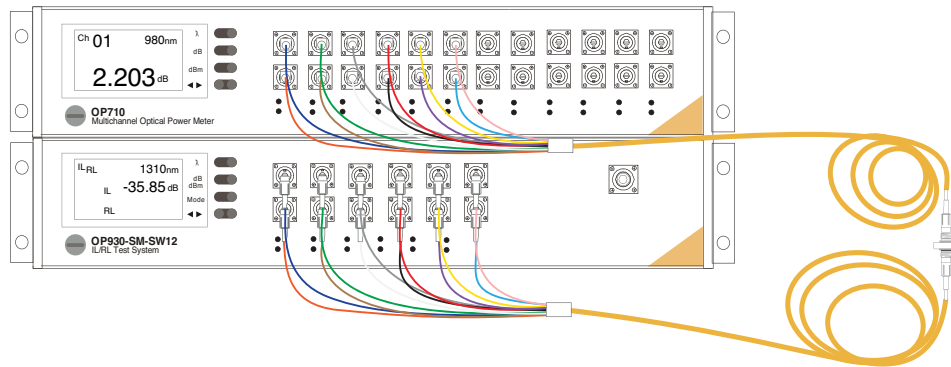

Figure 8: FiberMap output screen before analysis

Note that the power levels where there is no connection (i.e. A1:B12, A3:B1) read dark values. When the simulation is completed, it will highlight values within the threshold. This indicates a connection from one input to the output.

Doc: AN-109 Rev. A 5/17/13

Verifying Continuity with FiberMAP

AN-109

The highest power is added from all power measurements. For example, -20 dBm was measured as the highest power. Therefore, the connection A1:B1 would read 0, while A1:B2 would read 57.

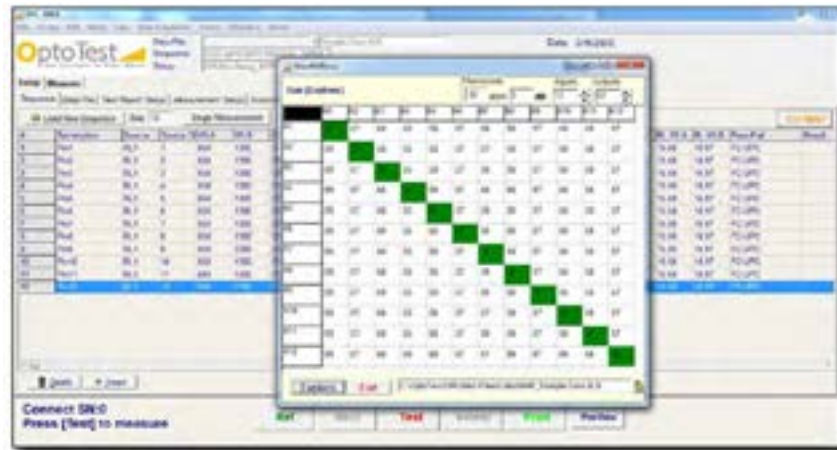

Figure 9: FiberMap output screen after analysis

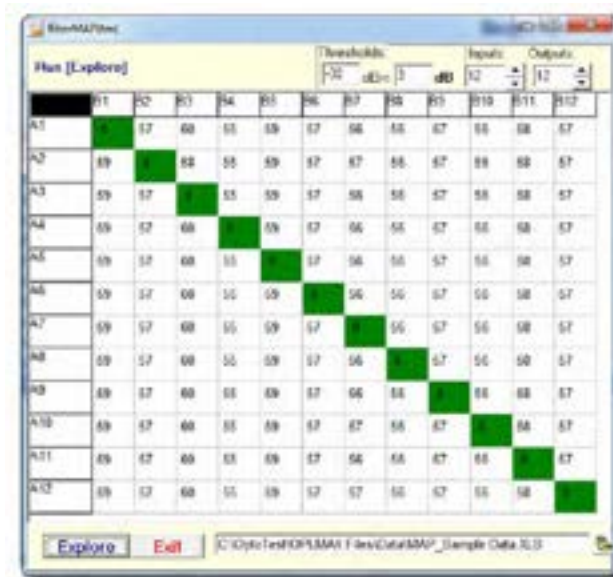

Figure 10: Shows an MTP-MTP cable with a 1:1 pinout (input 1 routes to output 1, etc.).

Doc: AN-109 Rev. A 5/17/13