



High Power UV-C LED S6060-DR250-265nm LEDs Specifications

V4.0 May 2022

RISK GROUP 3

**WARNING UV EMITTED FROM THIS PRODUCT
AVOID EYE AND SKIN EXPOSURE TO UNSHEIELDED PRODUCT**

AVERTISSEMENT UV émis par ce produit. Éviter l'exposition des yeux et de la peau à un produit non protégé

ADVERTENCIA Emisión de rayos ultravioleta por este producto. Evite la exposición de los ojos y la piel al producto sin protección

警告 この製品から放出される紫外線。シールドされていない製品への目や皮膚の露出を避ける



CAUTION - RISK OF PERSONAL INJURY. THIS LED PACKAGE IS NOT INTENDED FOR GENERAL ILLUMINATION AND MAY REQUIRE THE USE OF SPECIAL SAFEGUARDS. INSTALL AND USE ONLY IN STRICT ACCORDANCE WITH THE PRODUCT AND PACKAGING MARKINGS

INTEGRATION OF THIS LED PACKAGE INTO LED LIGHT SOURCES (ARRAYS, LAMPS OR LUMINAIRES) OR ADDITION OF REFLECTIVE OR MAGNIFYING OPTICS MAY CHANGE THE EXPECTED PHOTOBIOLOGICAL SAFETY CHARACTERISTICS OF SUCH DEVICES. THE ASSIGNED RISK GROUP CLASSIFICATION OF THIS LED PACKAGE MAY NOT NECESSARILY INDICATE THE RISK GROUP CLASSIFICATION OF THE LED LIGHT SOURCE



S6060-DR250-265nm LEDs Specifications

1. Identification Convention

SMD6060 type package

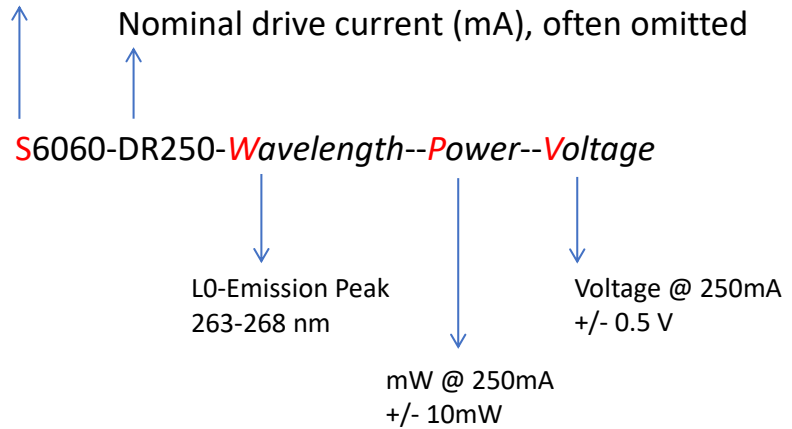

Example:

S6060-DR250-W265-P100-V

Interpretation:

Surface Mount type 6.0 x 6.0 mm packaged LED
 Nominal Drive Current = 250 mA
 Peak wavelength = 265 (263-268 nm) or L0
 Power output @ 250mA =90- 110 mW or U1
 Forward voltage @ 250mA =6.5-7.5 V or V2

Product specifications subject to change without notice

S6060-DR250-265nm LEDs Specifications

2. Outline Dimensions

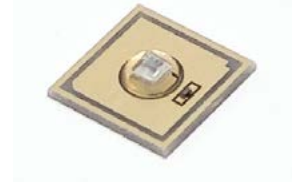

SMD 6060

① Anode (+)

② Cathode (-)

All unit in mm

Do not apply pressure to the dome lens on packaged LEDs

Bottom view

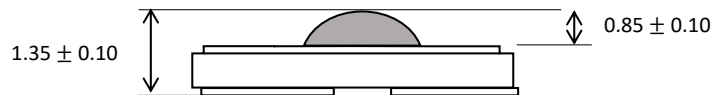
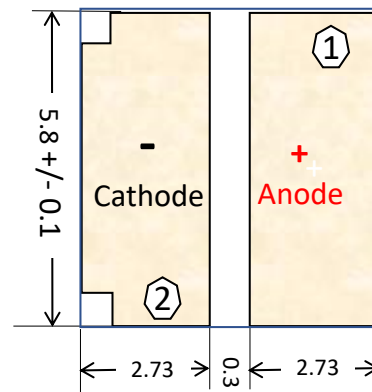
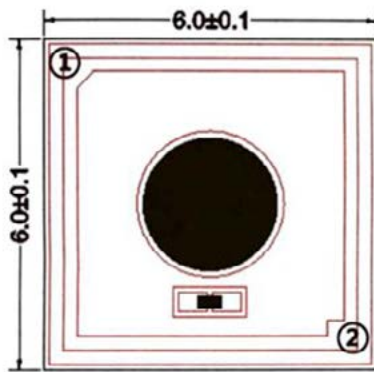

Recommended Solder Pattern on PCB

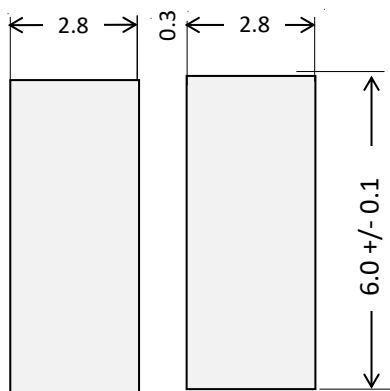

Electrical scheme of SMD

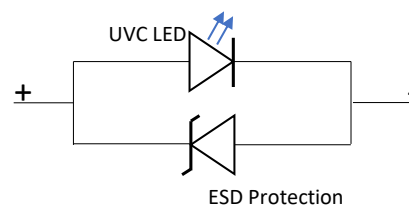

Specifications Subject to Change without notice

S6060-DR250-265nm LEDs Specifications

3. Hex S6060 LEDs Diagram

SMD LED on Hex MCPCB

All sizes in mm

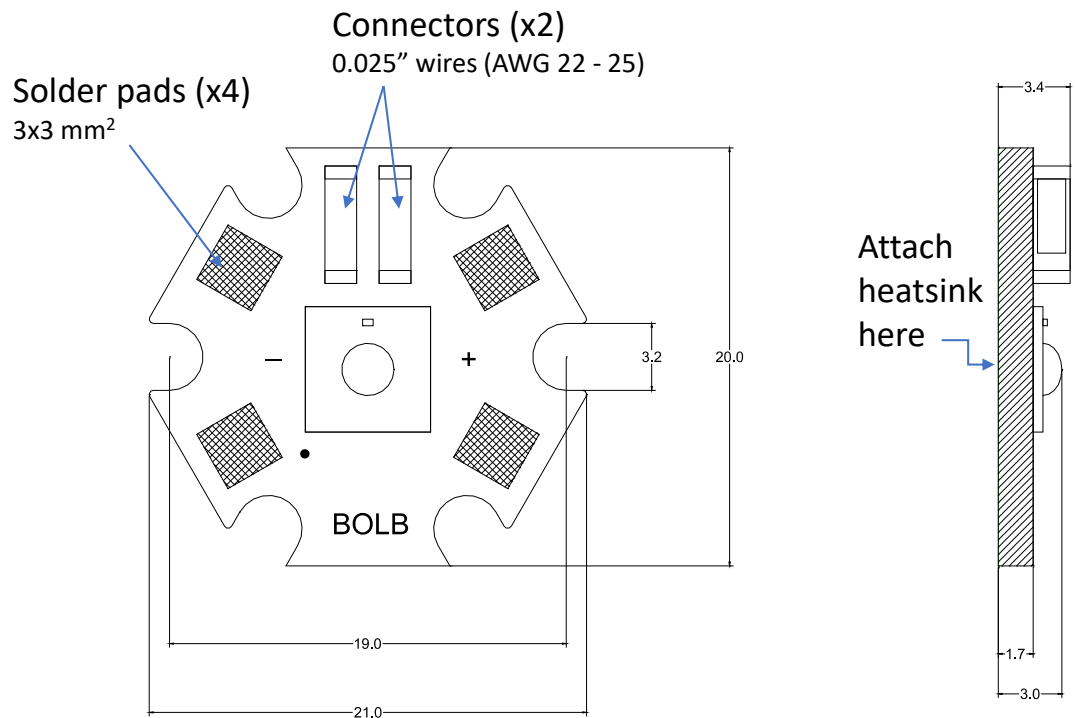

Product benefits

- Same popular MCPCB format for visible LEDs
- Eliminates reflow soldering
- Plug-n-play with 0.025" wires (AWG 24 or 25)
- Larger contact area for heat extraction
- Nomenclature example:
H6060-DR250-L0-P100-V7

S6060-DR250-265nm LEDs Specifications

4. Absolute Maximum Ratings at Ta=25°C

Parameter	Symbol	Min	Typical	Max	Unit
Forward Current	I_F	100	250	350	mA
Pulse Forward Current	I_{FP}	-	-	500	mA
Power Dissipation	PD	0.8	1.8	2.8	W
Operating Temperature	T_{opr}	10	-	+60	°C
Storage Temperature	T_{stg}	-40	-	+100	°C
Junction Temperature	T_j	-	-	80	°C
Electrostatic Discharge	ESD	-	-	2000	V

5. Typical Optical Electrical Parameters at Ta=25°C

Parameter	Conditions	Symbol	Min.	Typ.	Max	Unit
Peak Wavelength ^[1]	I=250mA	λ_p	263	265	268	nm
Radiant Flux ^[2]		ϕ_e	90	100	-	mW
Forward Voltage ^[3]		V_F	6.5	7.0	7.5	V
Spectrum Half Width		$\Delta\lambda$	9	10	11	nm
View Angle ^[4]		$2\theta_{\frac{1}{2}}$	-	150	-	°
Thermal Resistance Junction-Board ^[5,6]		$R_{th\ j-b}$	-	10	-	°C/W

Notes:

1. Peak Wavelength Tolerance ± 2 nm
2. Radiant Flux Measurement tolerance $\pm 10\%$
3. Forward Voltage Tolerance $\pm 3\%$
4. View angle Tolerance $\pm 10^\circ$
5. $R_{th\ j-b}$ is the thermal resistance from chip junction to bottom of MCPCB
6. Reference for thermal resistance: Using 2.5x2.5x1.6cm aluminum MCPCB

S6060-DR250-265nm LEDs Specifications

6. Characteristic diagrams at Ta=25°C

FIG 1. Forward Current vs. Forward Voltage

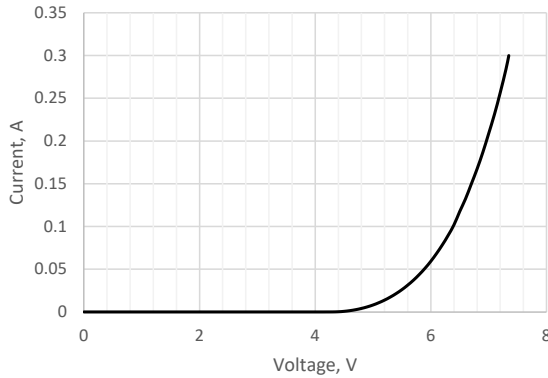

FIG 2. Relative Radiant Flux vs. Forward Current

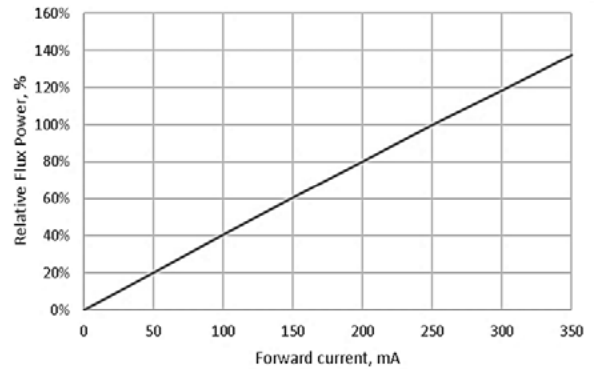

FIG 3. Peak Wavelength vs. Temperature of SMD

[Ta=25°C, I_F=250mA]

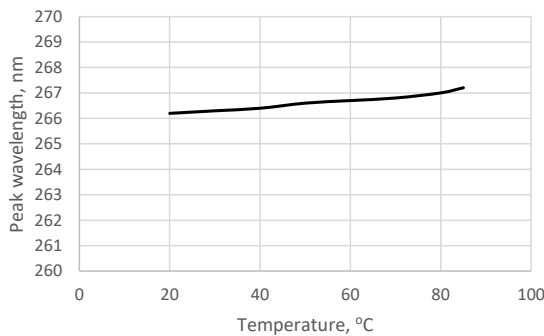

FIG 4. Typical Spectrum

[Ta=25°C, I_F=250mA]

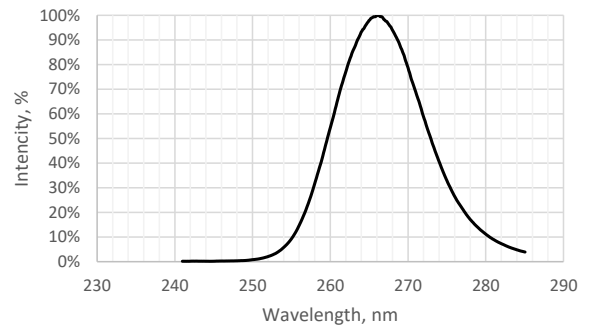

Fig 5. Forward Voltage vs Ambient Temperature

[Ta=25°C, I_F=250mA]

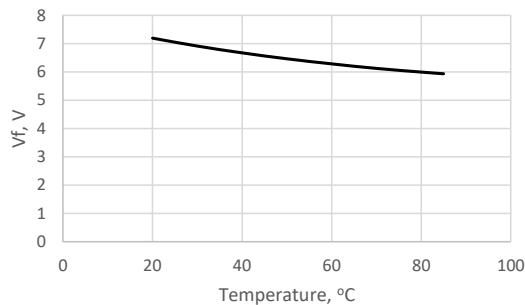
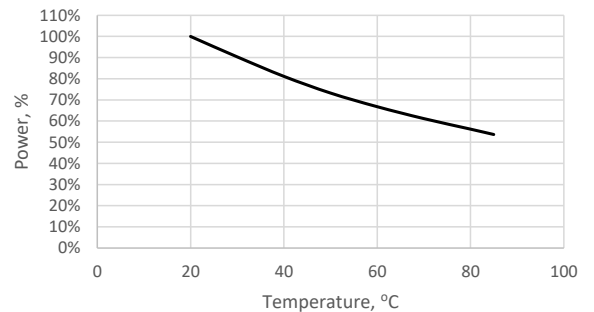

Fig 6. Relative Radiant Flux vs Ambient Temperature

[Ta=25°C, I_F=250mA]



S6060-DR250-265nm LEDs Specifications

Fig 7. Far-field Emission Pattern (Relative Intensity vs. Emission Angle)

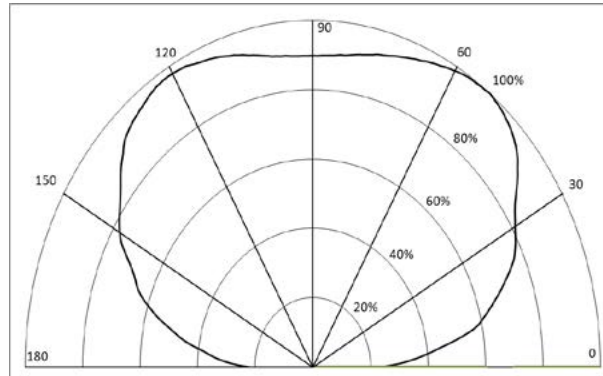

Diagram for Hemispherical
Lens LED Only

7. Lifetime at 250mA at Ta=25°C

Parameter	Symbol	Unit	Typ.
70% Power Lifetime	L70	hours	8000*
50% Power Lifetime	L50	hours	15000*

*Values based on standard Bolb test conditions 25°C +/- 2°C solder-point temperature subject to change: please inquire about latest update

Additional Testing and Certifications:

- Moisture Sensitivity Test: MSL Rating 5
- BOLB LEDs are RoHS and REACH compliant
- Bolb LEDs produce zero ozone

S6060-DR250-265nm LEDs Specifications

8. Bin Structures

[Ta =25°C, I_F = 250mA]

Designate ^[1]	Information	Code	Min	Typ.	Max.
W	Peak Wavelength (nm)	265 (L0)	263	265	268
P	Radiant Flux (Φ _e) (mW)	U1	90	100	110
		U2	110	120	130
V	Forward Voltage (V)	V2	6.5	7.0	7.5

Note:

1. Bin code definitions are as follows: Peak Wavelength = W ; Radiant Flux = P ; Forward Voltage = V

S6060-DR250-265nm LEDs Specifications

9. Typical Intensity Distribution of S6060 with Hemispherical Lens

100 mW UVC S6060

Short Distance Intensity Data				
Distance (cm)	0.5	1	1.5	2
Intensity (mW/cm ²)	120	30	23	10.5

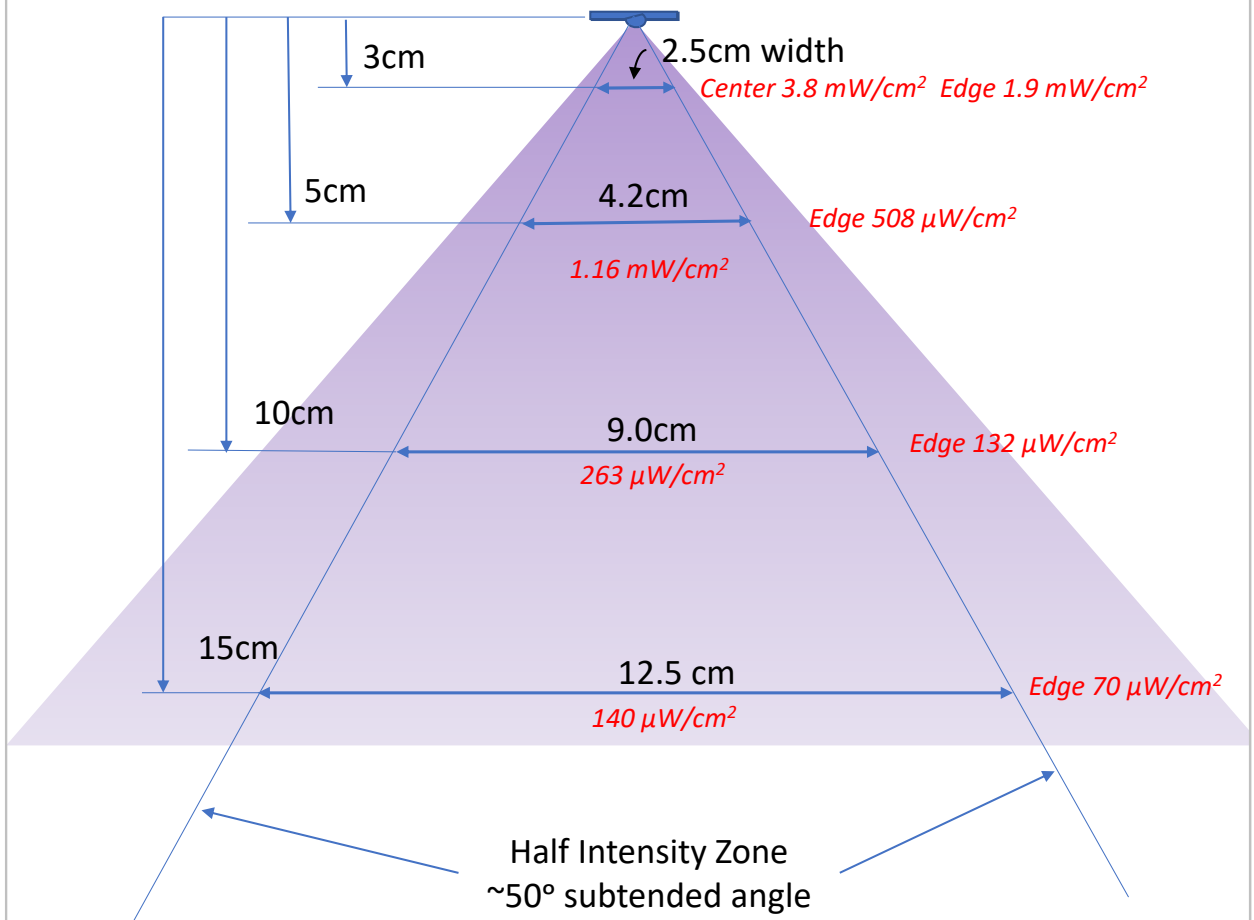

Fig 8. Typical Intensity Distribution of S6060 with Hemispherical Lens

S6060-DR250-265nm LEDs Specifications

10. Intensity Distribution of SMD6060 at long distance

Long Distance SMD6060 Intensity Distribution
Intensity Linearly Scales with LED Output Power

		Intensity ($\mu\text{W}/\text{cm}^2$) at Lateral Distance (cm)		
S6060 100mW	Vertical Distance (cm)	0 (on-axis)	20	50
	20	78	21.6	5.0
	40	18.5	14.2	5.0
	60	8.4	7.5	4.5
	80	4.4	4.1	3.0
	100	3.8	3.0	2.3
	120	2.0	1.9	1.4

S6060-DR250-265nm LEDs Specifications

11. Solder Reflow Temperature Profile

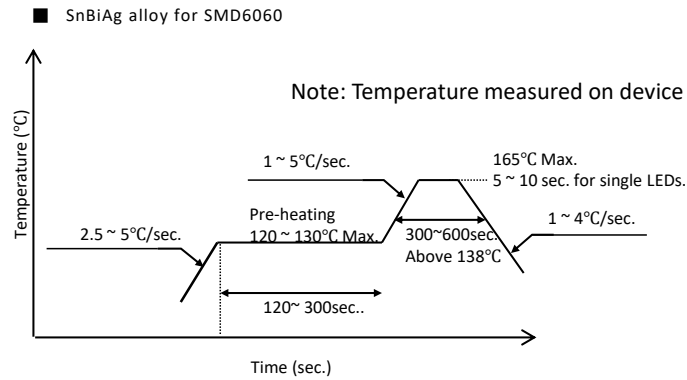

Reflow Soldering Instructions	
	SnBiAg alloy (Melting Temperature=138°C)
Pre-Heating	120 ~ 130°C
Pre-Heat Time	120sec. ~ 300sec. Max.
Peak Temperature	165°C Max.
Time at Peak Temperature	10 sec recommended

- Recommended solder composition: SnBiAg alloy or 174-T4 soldering paste)
- Recommended stencil thickness: 60~80µm
- Recommended stencil solder paste area: 60~80%
- For best results, the recommended forming gas is: 5%-7%H₂ in N₂ ambient
- Avoid rapid cooling after reflow soldering
- A convection-type reflow oven is preferred. If this is not an option, use a temperature-calibrated hot plate. **DO NOT use heat gun (blower) for soldering.**

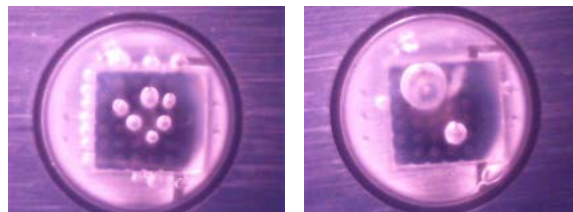

FIG 9. Examples of bubble formation due to failure to follow the above instructions.

S6060-DR250-265nm LEDs Specifications

12. Reliability

(1) Test and results

Test	Reference Standard	Test Conditions	Test Duration	Failure Criteria #	Units Failed/Tested
Resistance to Soldering Heat (Reflow Soldering)	JEITA ED-4701 300 301	Tsld=165°C, 10sec, 2 reflows		#1	0/10
Thermal Shock (Air to Air)		-40°C to 100°C, 15 mins dwell	1000cycles	#1	0/10
High Temperature Storage	JEITA ED-4701 200 201	Ta=100°C	1000hrs	#1	0/10
Low Temperature Storage	JEITA ED-4701 200 202	Ta=-40°C	1000hrs	#1	0/10
Room Temperature Operating Life		Ta=25°C, If=350mA, Test Board: See Notes Below	1000hrs	#1	0/10
High Temperature Operating Life		Ta=60°C, If=250mA, Test Board: See Notes Below	1000hrs	#1	0/10
Low Temperature Operating Life		Ta=10°C, If=350mA, Test Board: See Notes Below	1000hrs	#1	0/10
Vibration	JEITA ED-4701 400 403	200m/s ² , 100-2000-1000Hz 4 cycles, 4 min, each X,Y,Z	48 minutes	#1	0/10
Electrostatic Discharges(with TVS)	JEITA ED-4701 300 304	HBM, 2KV,1.5kΩ,100pF 3 pulses, alternately positive or negative		#1	0/10

Notes: Aluminum PCB board=1.5mm, R_{θJA}=25°C/w

(2) Failure Criteria

Criteria #	Items	Conditions	Failure Criteria
#1	Forward Voltage(Vf)	IF=250mA	>initial value *1.1 <initial value *0.85
	Radiant Flux(ØE)	IF=250mA	<initial value *0.7

12. Storage Condition

Conditions		Temperature	Humidity	Time
Storage	Before opening aluminum bag	<=30°C	<=90%RH	With 1 year from delivery
	After opening aluminum bag	<=30°C	<=60%RH	<=48hr
Baking		65±5°C		>=24hr

Notes:

1. LED packages may absorb moisture; therefore, you must store the LEDs in moisture-proof bags.
2. To avoid failure, solder the LEDs onto PCBs within 24 hours after opening the moisture-proof bags.
3. If not used within 48 hours, Bolb recommends placing open bags into a nitrogen purge dry box.

S6060-DR250-265nm LEDs Specifications

13. Handling Procedures: ESD Protection

Workplace setup should follow the recommendations given in JEDEC standard document JESD625B “Requirements for Handling Electrostatic-Discharge-Sensitive (ESDS) Devices” or IEC 61340-5-1,2 and 3. In addition, properly train operators to handle UVC flip chips according to the guidelines listed below:

- Always wear conductive wrist straps when handling Bolb UVC LEDs—both on or off boards. Continuously monitor the conductive straps to ensure that they start and remain grounded.
- Use an ion blower to neutralize the static discharge that may build up on the surface of the UVC flip chips during storage and handling.
- Always keep new UVC flip chips in the protective ESD storage bag. Depending on the final application, it may be necessary to include additional ESD protection, such as a TVS protection diode on the substrate on which the UVC flip chip is reflowed. Bolb UVC LEDs have a TVS chip inside each package.
- Use tweezers to pick up UVC LEDs. To avoid scratching UVC LEDs, Bolb recommends using Teflon-coated tweezers.
- Bolb recommends holding the LED from the sidewalls (see Figure 10.)
- Do not apply pressure to the dome lens on packaged LED.

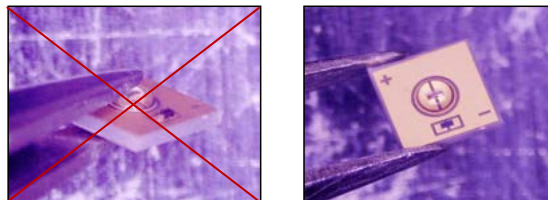
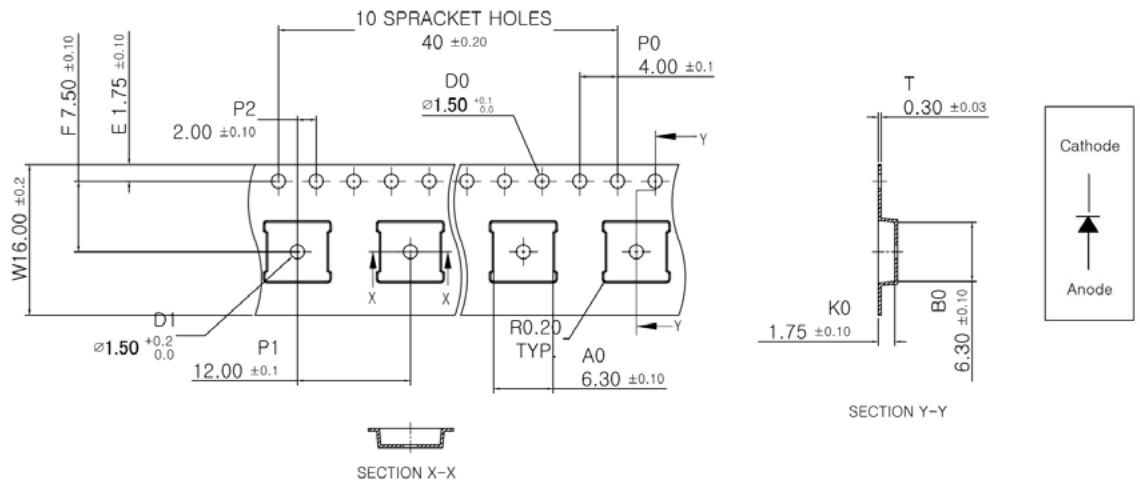

FIG 10. Incorrect handling (left) and correct handling (right) of UVC LED

S6060-DR250-265nm LEDs Specifications

14. Packing

Carrier Tape & Reel Dimensions (unit = mm)



180mm Reel
 Quantity 500 units/reel
 Cover tape adhesion <0.7 Newtons
 Leader tape > 35 empty pockets
 Trailer > 40 empty pockets

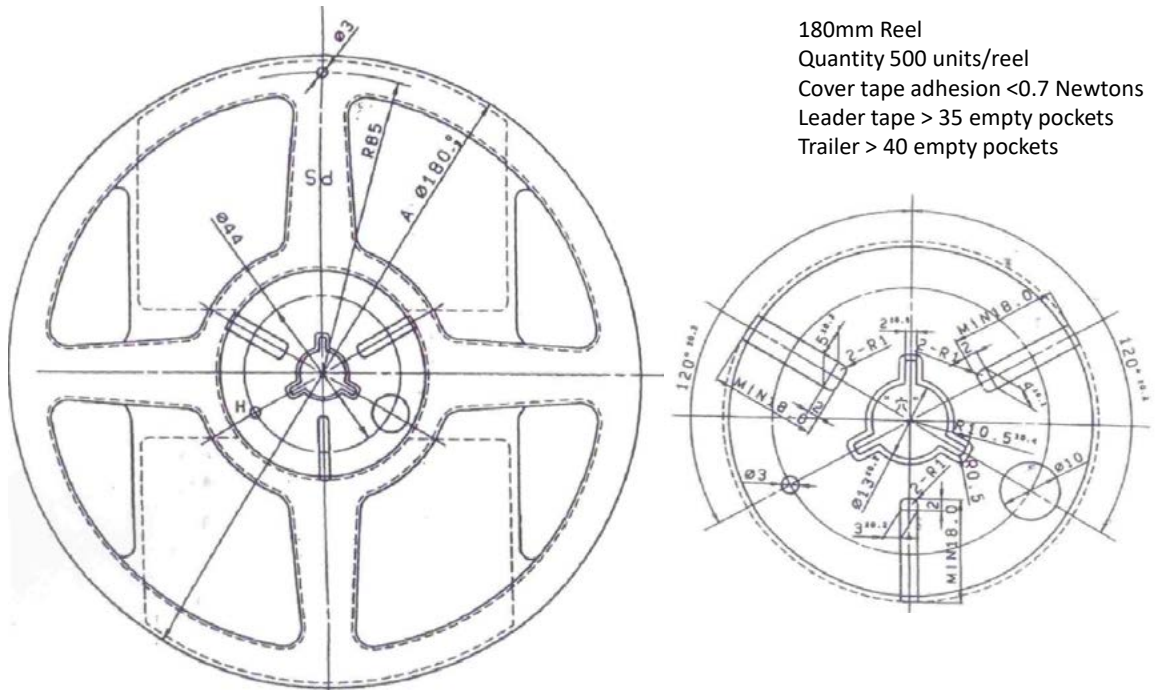

S6060-DR250-265nm LEDs Specifications

15. General Precautions and UVC Safety



WARNING UV emitted from this product. Avoid eye and skin exposure to unshielded product

AVERTISSEMENT UV émis par ce produit. Éviter l'exposition des yeux et de la peau à un produit non protégé

ADVERTENCIA Emisión de rayos ultravioleta por este producto. Evite la exposición de los ojos y la piel al producto sin protección

警告 この製品から放出される紫外線。シールドされていない製品への目や皮膚の露出を避ける

UVC LEDs emit deep ultraviolet radiation with extremely high intensity near their surface. High irradiance allows rapid disinfection, but users must observe safety precautions during assembly, testing, and field use.

By purchasing the UVC chips (bare dice), packaged LEDs, or arrays from BOLB Inc., the customer agrees to indemnify the manufacturer of any bodily harm due to failure to follow the common-sense precautions or warnings and guidelines contained within this Specification.

It is the buyer's responsibility to design products that ensure the safety of end users.

All assembly workers, operators, and bystanders must wear eye and skin protection when the UVC LEDs are energized. Therefore, bare-eye observation (including through microscopes) and bare-hand handling of a UVC LED in operation is **PROHIBITED**.

Because most materials readily absorb UVC light, any oil or other absorbent liquid or solid substance must **NOT** be allowed to touch the sapphire side of the UVC chip or the dome lens on a packaged LED.