



High Power UV-C LED

Product Specifications
6060 SMD TL Packaged LEDs

V1.86TL September 2021

Germany and Other Countries

Laser Components Germany GmbH
Tel: +49 8142 2864-0
Fax: +49 8142 2864-11
info@lasercomponents.com
www.lasercomponents.com

France

Laser Components S.A.S.
Tel: +33 1 39 59 52 25
Fax: +33 1 39 59 53 50
info@lasercomponents.fr
www.lasercomponents.fr

United Kingdom

Laser Components (UK) Ltd.
Tel: +44 1245 491 499
Fax: +44 1245 491 801
info@lasercomponents.co.uk
www.lasercomponents.co.uk

Nordic Countries

Laser Components Nordic AB
Tel: +46 31 703 71 73
Fax: +46 31 703 71 01
info@lasercomponents.se
www.lasercomponents.se

USA

Laser Components USA, Inc.
Tel: +1 603 821-7040
Fax: +1 603 821-7041
info@lasercomponents.com
www.lasercomponents.com



WARNING UV emitted from this product. Avoid eye and skin exposure to unshielded product

AVERTISSEMENT UV émis par ce produit. Éviter l'exposition des yeux et de la peau à un produit non protégé

ADVERTENCIA Emisión de rayos ultravioleta por este producto. Evite la exposición de los ojos y la piel al producto sin protección

警告 この製品から放出される紫外線。シールドされていない製品への目や皮膚の露出を避ける

6060 SMD Packaged LED Identification Convention

SMD6060 type package

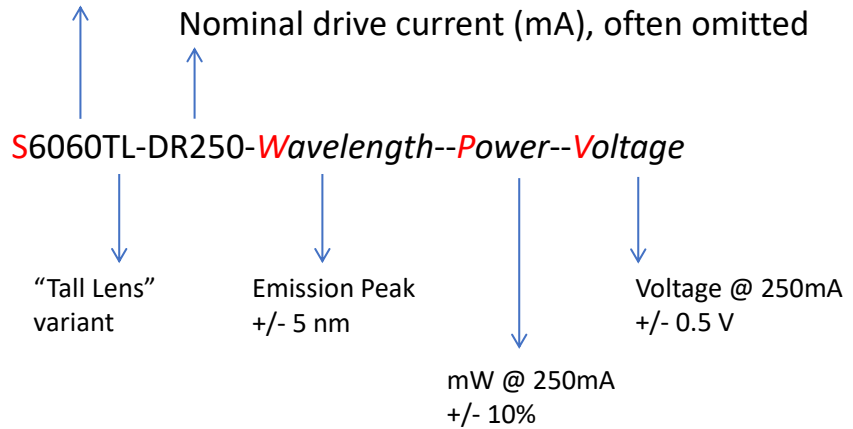

Example:

S6060TL-DR250-W275-P90-V6.5
S6060TL-W275-P90-V6.5

Interpretation:

Surface Mount type 6.0 x 6.0 mm packaged LED
Nominal Drive current = 250 mA
Peak wavelength = 275 +/- 5nm
Power output @ 250mA = 90 mW (+/-10%)
Forward voltage @ 250mA = 6.5V (+/- 0.5V)

Product specifications subject to change without notice

6060 SMD Tall Lens (TL) Packaged LED Diagram **SAMPLING ONLY**

6060 SMD – TL

① Anode (+)

② Cathode (-)

All unit in mm

Bottom view

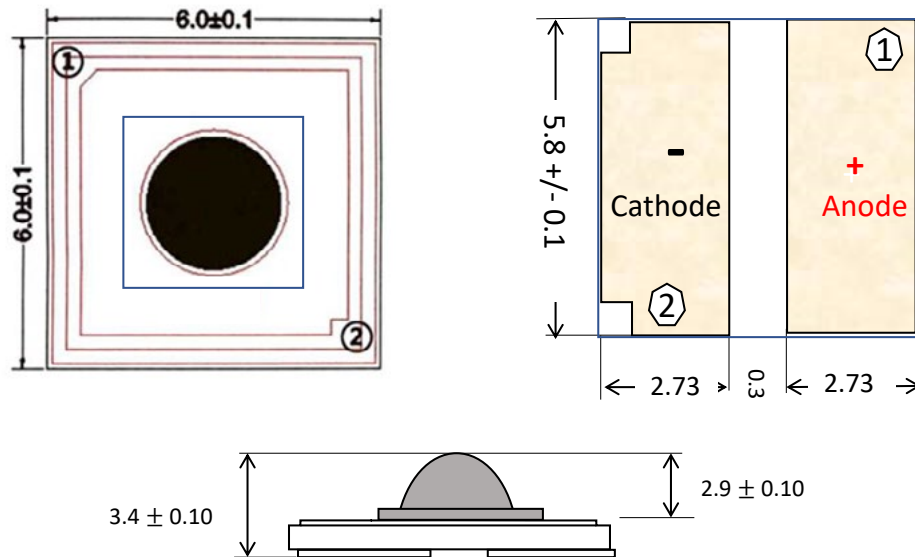

Recommended Solder Pattern on PCB

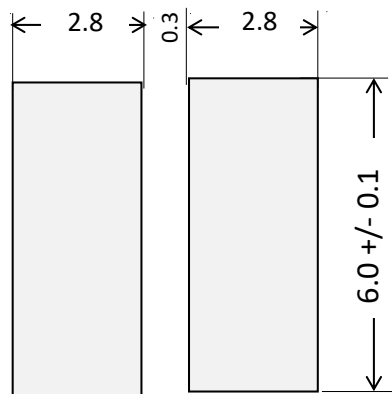

Electrical scheme of SMD

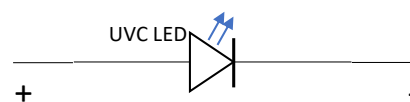

Special note: This product does not include a Zener/TVS chip. Customers are advised to add a Zener/TVS chip for ESD protection in the external driver circuitry

Specifications Subject to Change without notice

UVC LED: Electro-optical parameters at 250mA (Sampling only)

TABLE 1. Typical Performance at 250mA
(25°C ambient, packaged, Solder point temperature <38°C)

Parameter	Symbol	Unit	Min.	Typ.	Max
Peak Wavelength	λ_p	nm	268	275	280
Radiant Flux	ϕ_e	mW	70	90	100
Forward Voltage	VF	V	5.8	6.5	7.5
Spectrum Half Width	$\Delta\lambda$	nm		10	
View Angle	$2\theta_{1/2}$	°	36		42
Thermal Resistance	RJ-b	°C/W		<8	

TABLE 2. Maximum Ratings (25°C ambient, packaged device)

Parameter	Symbol	Limit	Unit
Maximum DC Drive Current	IFM	350	mA
Maximum Pulsed Drive Current	IFMP	500	mA
Maximum Reverse Voltage	VRM	-5	V
Maximum Junction Temperature	Tjmax	75	°C
Operating Temperature Limits	Topr	-20 ~ 60	°C
Storage Temperature	Tstg	-30 ~ 100 (Humidity <40%)	°C

UVC LED: Electro-optical parameters at 250mA

FIG 1. Forward Current vs. Forward Voltage

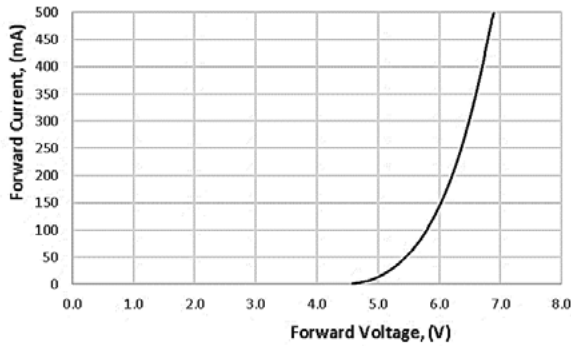

FIG 2. Relative Radiant Flux vs. Forward Current

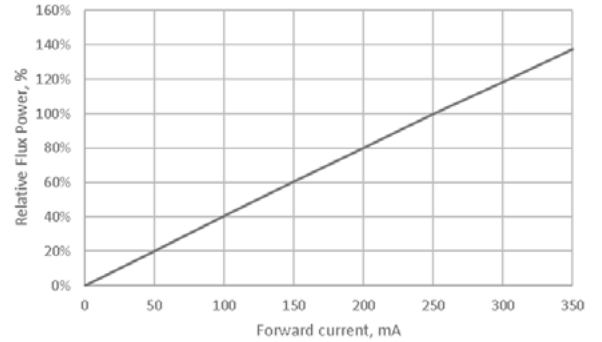

FIG 3. Peak Wavelength vs. Forward Current

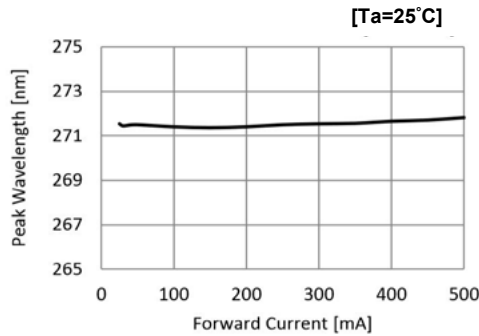

FIG 4. Typical Spectrum

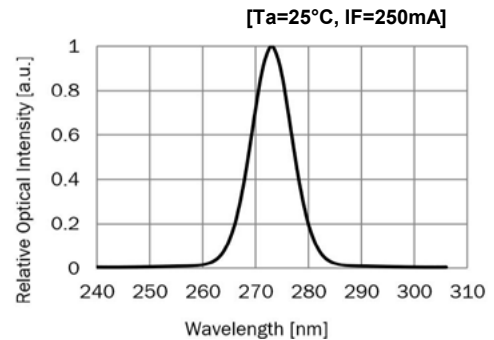

Fig 5. Forward Voltage vs Ambient Temperature

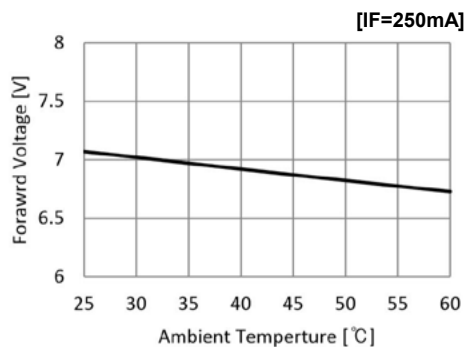
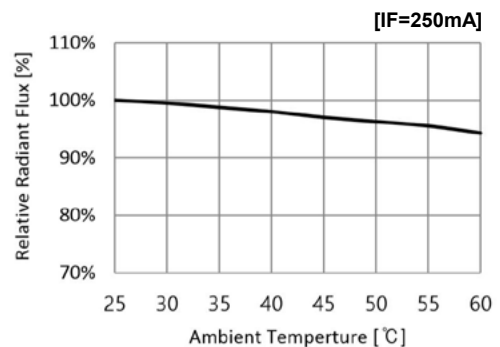

Fig 6. Relative Radiant Flux vs Ambient Temperature



UVC LED: Electro-optical parameters (continued)

TABLE 3. Device lifetime (forward current =250mA, Tj < 35°C)

Parameter	Symbol	Unit	Typ.
70% Power Lifetime	L70	hours	3000*
50% Power Lifetime	L50	hours	5000*

*Values based on standard Bolb test conditions 25°C +/- 2°C solder-point temperature

*Subject to change: please inquire about latest update

Additional Testing and Certifications:

- Moisture Sensitivity Test: MSL Rating 5/5A
- BOLB LEDs are RoHS and REACH compliant

Packing

Attention! The SMD6060 Tall Lens variant are shipped with standard static protected H44-250- trays (100 ps. SMD per tray maximum)

UVC LED: Electro-optical parameters SMD6060 Tall Lens TL (Sampling ONLY)

TABLE 3. Bin Structures

Note:

Tall lens LED (TL) will provide 90% of the flux of Low lens LEDs

But with significantly increased on-target intensity directly under LED

[Ta =25°C, I_F = 250mA]

Designate	Information	Code	Min	Typ.	Max.
W	Peak Wavelength	270	268	271	273
		275*	273	275	278
P	Radiant Flux (Φ _e)	90	80	90	100
		70	60	70	80
V	Forward Voltage (V)	5.5	5.0	5.5	6.0
		6.5*	6.0	6.5	7.0
		7.5	7.0	7.5	8.0

Note: * Dominant bin color coded purple

Bin Code (W-P-V): Peak Wavelength = W ; Radiant Flux = P ; Forward Voltage = V

Intensity Distribution of SMD6060 with Tall Lens (continued) **SAMPLING ONLY**

Projected Pattern
for SMD6060-TL

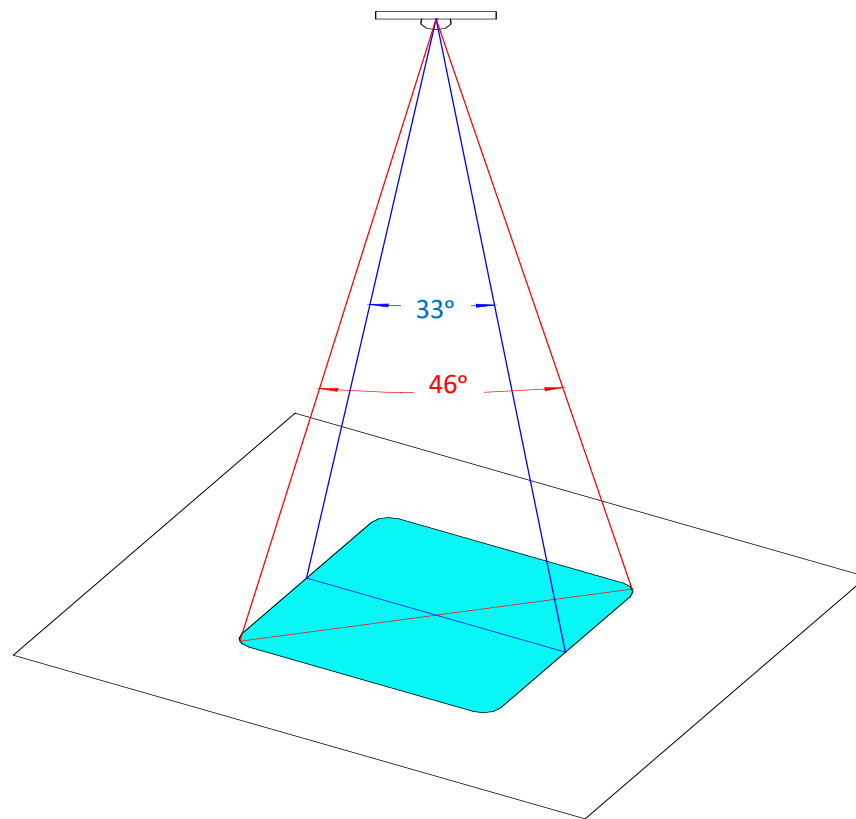

Intensity Distribution of SMD6060 with Tall Lens (TL) **SAMPLING ONLY**

90mW_{opt} UVC SMD6060-TL

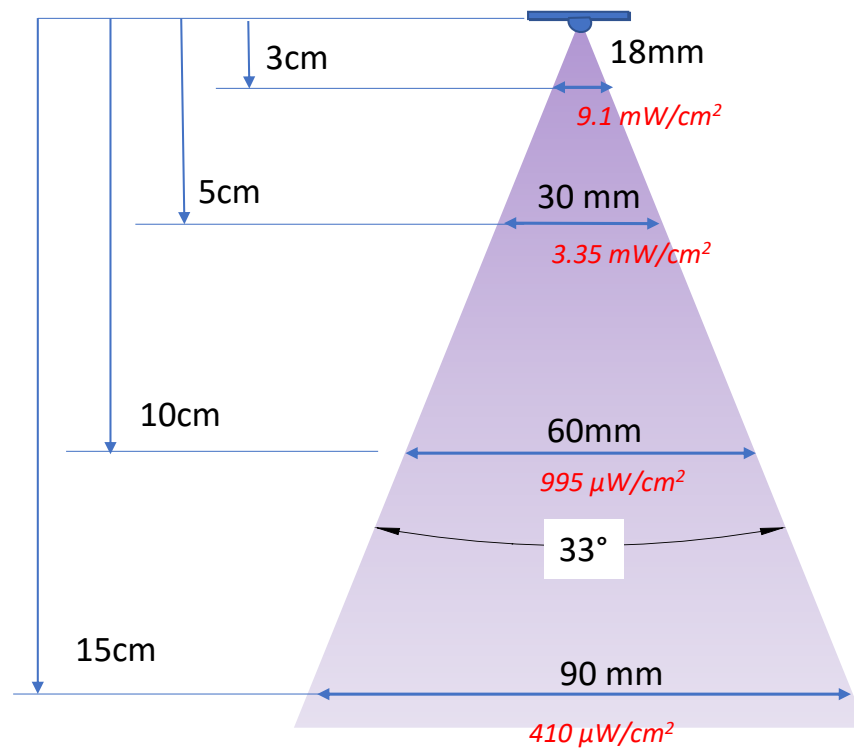

Intensity Distribution of SMD6060 –TL at different distance

Po Intensity ($\mu\text{W}/\text{cm}^2$)		lateral distance (cm)		
Long distance	vertical distance (cm)	0	20	50
SMD6060 –TL 90mW	20	275.0	13.1	<1.6
	40	62.2	9.8	<1.6
	60	26.2	8.2	<1.6
	80	14.8	5.0	<1.6
	100	9.8	4.1	<1.6
	120	6.6	3.2	<1.6

Short distance	vertical distance (cm)	Po Intensity (mW/cm^2)
SMD6060 –TL 90mW	0.1	527
	1.0	22.2
	3.0	9.1
	5.0	3.4
	10.0	1.0
	15.0	0.4

Soldering conditions of UVC LED

FIG 8. Solder reflow temperature profile

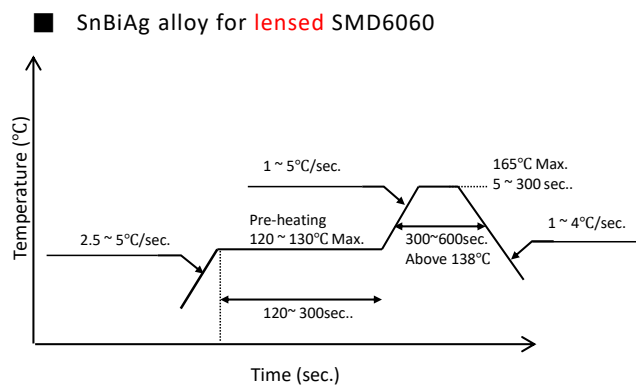

Reflow Soldering Instructions	
	SnBiAg alloy (Melting Temperature=138°C)
Pre-Heating	120 ~ 130°C
Pre-Heat Time	120sec. ~ 300sec. Max.
Peak Temperature	165°C Max.
Time at Peak Temperature	10 sec recommended 300 sec. Max. for large arrays

- Recommended solder composition: SnBiAg alloy or 174-T4 soldering paste)
- Recommended stencil thickness is 60~80um
- Recommended stencil solder paste area is 60~80%
- Forming gas (5%-7% H_2 in N_2) ambient recommended for best results
- After reflow soldering, Rapid cooling should be avoided
- When soldering, do not use a none calibrated hot plate. A convection type reflow oven is preferred. (Fig 8.)

Must not use heat gun (blower) for soldering

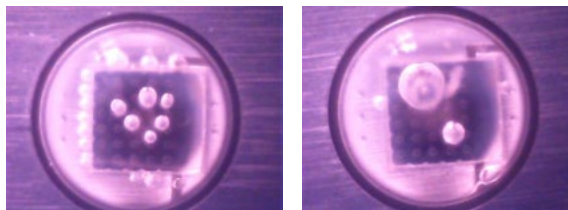

FIG 9. Examples of bubble formation due to failure to follow the above instructions.

Handling Precautions

ESD Protection

Workplace setup should follow the recommendations given in JEDEC standard document JESD625B "Requirements for Handling Electrostatic-Discharge-Sensitive (ESDS) Devices" or IEC 61340-5-1,2 and 3. The operators should be properly trained to handle UVC flipchips according to the guidelines listed below:

- Always wear conductive wrist straps that is continuously monitored when working or handling assembled boards containing unprotected chips.
 - Use an ion blower to neutralize the static discharge that may build up on the surface of the UVC flipchips during storage and handling.
 - Always keep unused UVC flipchips in the protective ESD storage bag. Depending on the final application, it may be necessary to include additional ESD protection, such as a TVS protection diode on the substrate on which UVC flip chip is reflowed. Bolb Inc. includes a TVS chip inside each LED package.
 - Use tweezers to pick up UVC LEDs, teflon coated tweezers would be recommended to avoid scratching UVC LEDs.
 - Recommend holding the sidewalls of the LEDs (See Fig 10.)
- *Do not apply pressure to the dome lens on packaged LED.

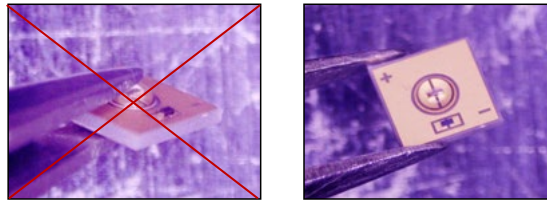

FIG 10. incorrect handling (left) and correct handling (right) of UVC LED Package

General Precautions and UVC Safety



WARNING UV emitted from this product. Avoid eye and skin exposure to unshielded product

AVERTISSEMENT UV émis par ce produit. Éviter l'exposition des yeux et de la peau à un produit non protégé

ADVERTENCIA Emisión de rayos ultravioleta por este producto. Evite la exposición de los ojos y la piel al producto sin protección

警告 この製品から放出される紫外線。シールドされていない製品への目や皮膚の露出を避ける

UVC LEDs emit deep ultraviolet radiation, with extremely high intensity near their surface. This allows rapid disinfection but safety precautions must be observed during assembly, testing and field use.

By purchasing the UVC chips (bare dice), packaged LEDs or arrays and from BOLB Inc., the customer agrees to indemnify the manufacturer of any bodily harm as a result of failure to follow the common sense precautions, or warnings and guidelines contained within this Specifications.

It is the buyer's responsibility to properly design products that ensure safety of end users.

All assembly workers, operators and bystanders must wear eye and skin protection when the UVC LEDs are energized. Bare-eye observation (including through microscopes) and bare-hand handling of a UVC LED in operation is **PROHIBITED**.

UVC light can be easily absorbed, so any oil or other absorbent liquid or solid substance must **NOT** be allowed to touch the sapphire side of the UVC chip, or the dome lens on a packaged LED.