

HI-FAC-Series 1550 nm High Intensity Pulsed Laser Diodes with Fast Axis Collimators

Features

- Fast axis collimation 15/10/5 mrad options
- Up to 16 W peak power
- Hermetic package
- Extremely robust
- High reliability

Applications

- Eye safe range finding
- Surveying equipment
- "Friend or Foe" identification
- Laser radar
- Security barrier

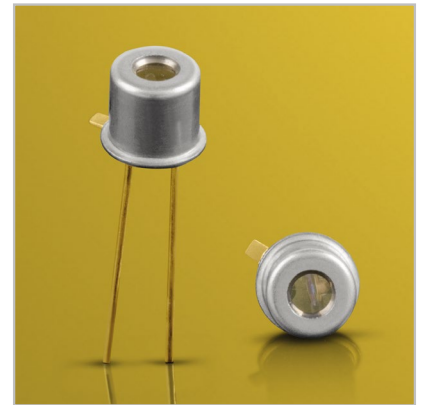

Optical Characteristics at $t_{RT} = 21^{\circ}\text{C}$, I_{FM}

	Min	Typ	Max	Units
Wavelength of peak radiant intensity λ	1520	1550	1580	nm
Spectral width $\Delta\lambda$ at 50% intensity points at I_{FM}		19.5		nm
Wavelength temperature coefficient		0.5		nm/ $^{\circ}\text{C}$
Divergence, w.r.t. junction plane				
Parallel, \parallel		12		Degrees
Perpendicular, \perp with 275 μm EFL lens		9.5		mrad
Perpendicular, \perp with 590 μm EFL lens		5		mrad
Perpendicular, \perp with 150 μm EFL lens		15		mrad
Perpendicular, \perp with 750 μm EFL lens		3.8		mrad

Typical Product Characteristics

Conditions are $t_{\text{RI}} = 21^\circ\text{C}$, $t_w = 100 \text{ ns}$, $P_{\text{rr}} = 1.0 \text{ kHz}$

	HI155G1S04SCX	HI155G1S07SCX	Units
P_o at I_{FM} (typ.)	10	16	W
Emitter size	100 x 1	180 x 1	μm
Max. I_{FM} at 150 ns	30	46	A
Threshold I_{TH}	0.6	0.9	A
Forward voltage at I_{FM}	9	8	V

I_{FM} is the maximum peak current under any drive condition and is applicable to devices operated for short and intermittent duration such as in hand held range finders.

For applications that demand continuous use at maximum duty factor, we recommended I_{FM} at 50% to ensure longevity. High temperature operation will reduce peak power and MTF so for optimal performance under high stress conditions it is important to provide an adequate heat sink.

Absolute Maximum Ratings

Maximum ratings	Limiting values
Peak forward current (I_{FM})	50 A
Peak reverse voltage	6 V
Pulse duration	150 ns
Duty factor	0.10%
Temperature	
- Storage	-55 °C to + 100 °C
- Operating	-45 °C to + 85 °C
Lead soldering	
- 5 seconds max at	200 °C

Environmental

Hermeticity, $< 10^8 \text{ cm}^3/\text{s}$

Mechanical shock, 1 ms 1500 g, MIL-STD-883F, Method 2002 4, Condition B

Thermal shock, -40° to +85°C, JEDEC JESD22-A104C, Condition N

Curves

Fig. 1: Power Output vs. Temperature

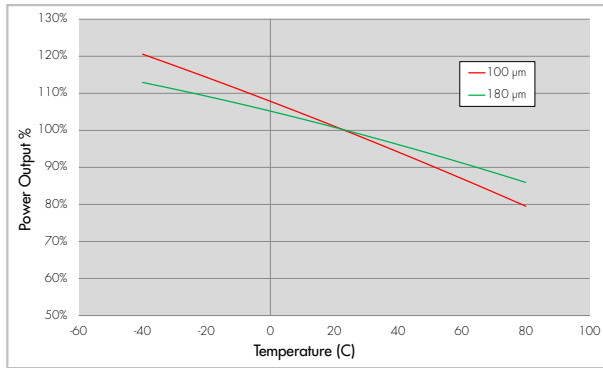

Fig. 2: PI Plot - 100 μm, 180 μm

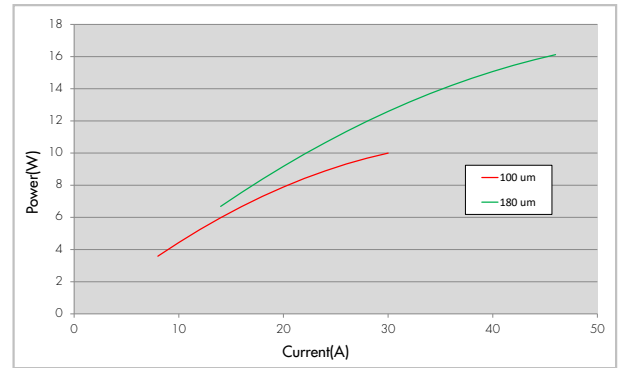

Fig. 3: Wavelength vs. Temperature

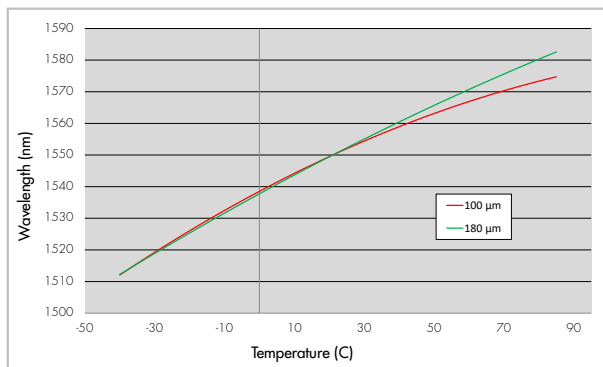
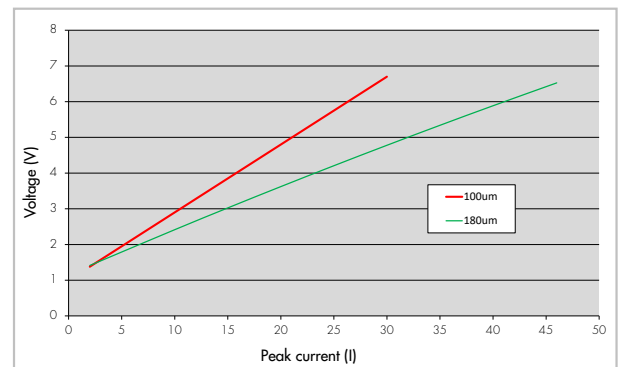
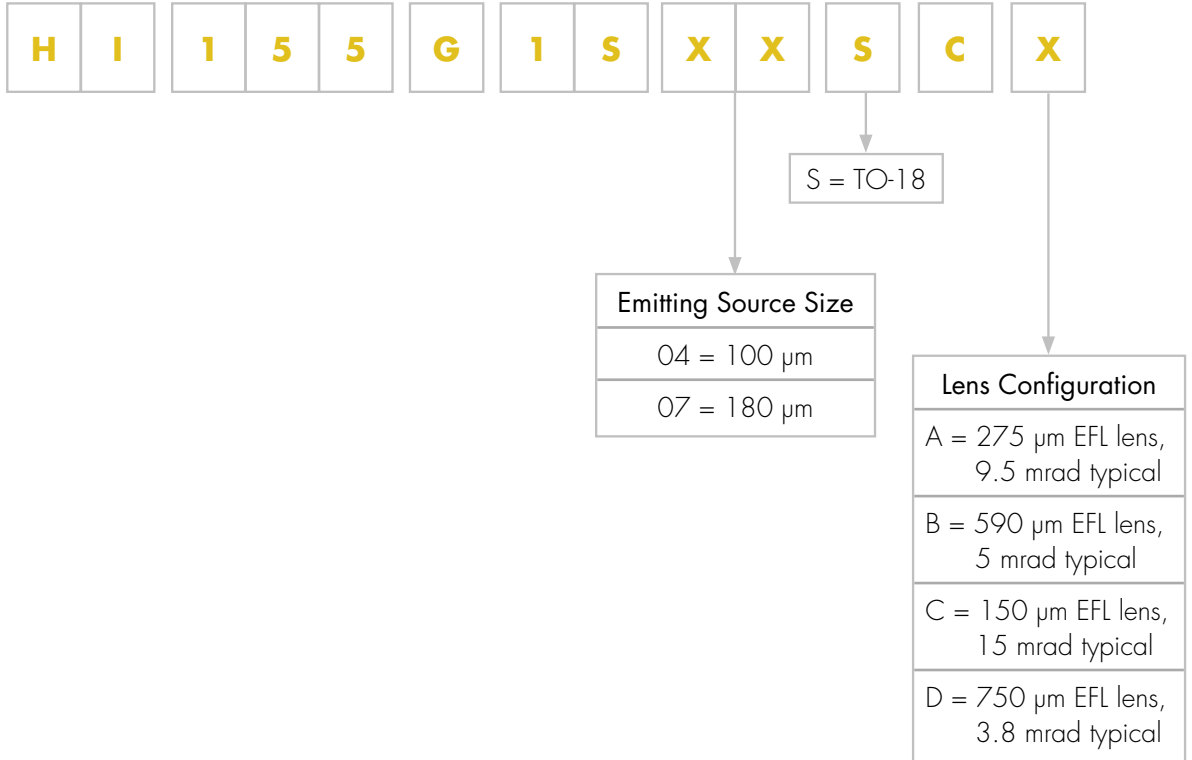

Fig. 4: Static Forward Voltage



Product Number Designations



Package Drawings

Package S TO-18

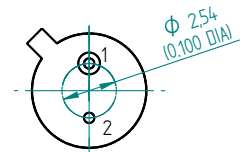
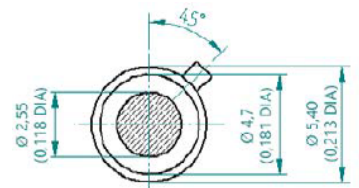
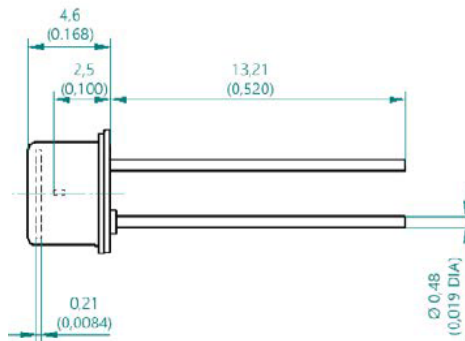
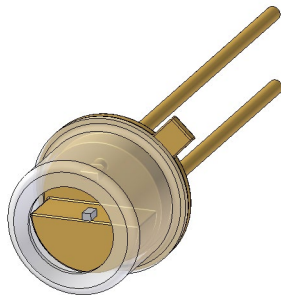

Package S: Pin Out: 1. LD Anode (+), 2. LD Cathode (-) Case, Inductance 5.2 nH

bottom view

06/23 / V15 / EDIF / lepld/hi-fac-pulsed-laser-diodes

Product Changes

LASER COMPONENTS reserves the right to make changes to the product(s) or information contained herein without notice. No liability is assumed as a result of their use or application.

Ordering Information

Products can be ordered directly from LASER COMPONENTS or its representatives. For a complete listing of representatives, visit our website at www.lasercomponents.com

Custom designed products are available on request.

Laser Safety

Personal Hazard:

Depending on the mode of operation, these devices emit highly concentrated non visible infrared light which can be hazardous to the human eye. Products which incorporate these devices have to follow the safety precautions given in IEC 60825-1 "Safety of laser products".

Handling Precautions:

Products are subject to the risks normally associated with sensitive electronic devices including static discharge, transients, and overload.

