

AlGaAs Infrared Laser Diode

ADL-85Y51TU

6-2D-LD85-029_Rev.00

850nm 250mW High Power Operation

Features

- 250mW kink free power
- Small package: Ø5.6mm
- Small far field angle
- High reliability/ Low astigmatism/ High efficiency

Applications

- Light source for sensing device
- LIDAR (light detection & ranging)
- 3D Sensing with Laser
- Illumination/ Medical application/ Imaging

Absolute maximum ratings

Parameter	Symbol	Condition	Rating	Unit
Light output power	P _O	CW	270	mW
Reverse voltage (LD)	V _{RL}	-	2	V
Case temperature	T _C	-	-10~+60	°C
Storage temperature	T _S	-	-40~+85	°C

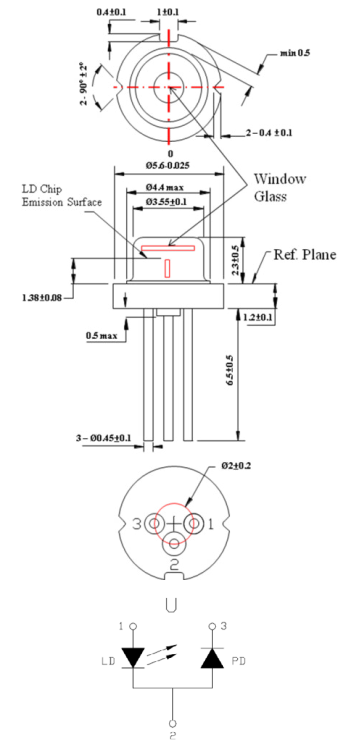

Electrical and optical characteristics (T_c=25 °C)

Parameter	Symbol	Min.	Typ.	Max.	Unit	Conditions
Peak wavelength	λ	840	850	860	nm	P _O =250mW
Threshold current	I _{th}	-	65	90	mA	
Operating current	I _{op}	-	310	360	mA	
Operating voltage	V _{op}	-	1.9	2.4	V	
Differential efficiency	η	0.90	1.00	-	mW/mA	P _O =200-250mW
Monitor current	I _m	0.5	1.1	1.8	mA	P _O =250mW, V _{RD} =5V
Parallel divergence angle	θ	6	8	13	deg.	P _O =250mW
Perpendicular divergence angle	θ _⊥	12	17	22	deg.	
Parallel FFP deviation angle	Δθ	-3	0	+3	deg.	
Perpendicular FFP deviation angle	Δθ _⊥	-3	0	+3	deg.	
Emission point accuracy	ΔxΔyΔz	-80	0	+80	um	

* Sufficient heat dissipation is required for CW operation.

● Precautions

- Do not operate the device above maximum ratings. Doing so may cause unexpected and permanent damage to the device.
- Take precautions to avoid electrostatic discharge and/or momentary power spikes. A change in the characteristics of the laser or premature failure may result.
- Proper heat sinking of the device assures stability and lifetime. Always ensure that maximum operating temperatures are not exceeded.
- Observing visible or invisible laser beams with the human eye directly, or indirectly, can cause permanent damage. Use a camera to observe the laser.
- No laser device should be used in any application or situation where life or property is at risk in event of device failure.
- Specifications are subject to change without notice. Ensure that you have the latest specification by contacting us prior to purchase or use of the product

For reference only. Contents above are subject to change without notice.

AlGaAs Infrared Laser Diode

ADL-85Y51TU

6-2D-LD85-029_Rev.00

850nm 250mW High Power Operation

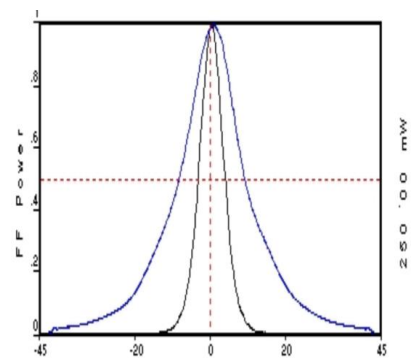
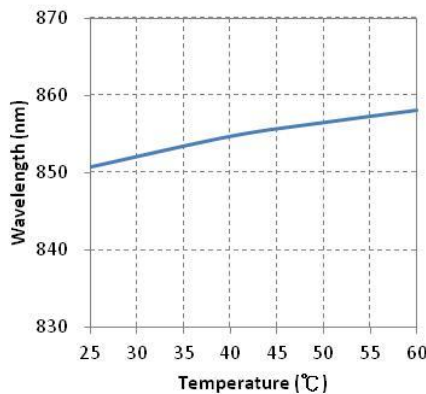
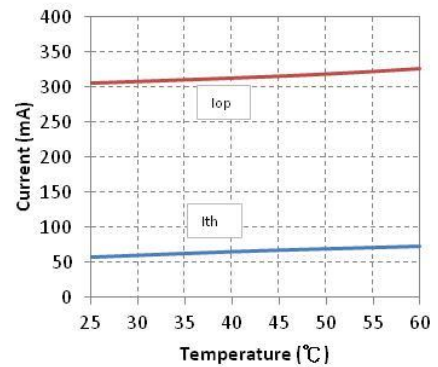
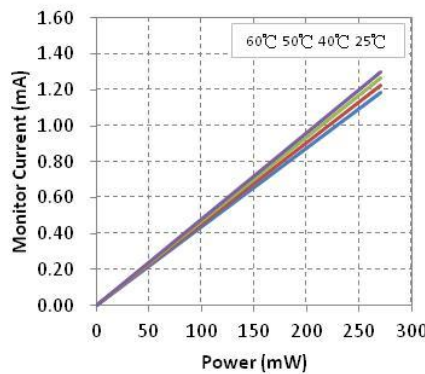
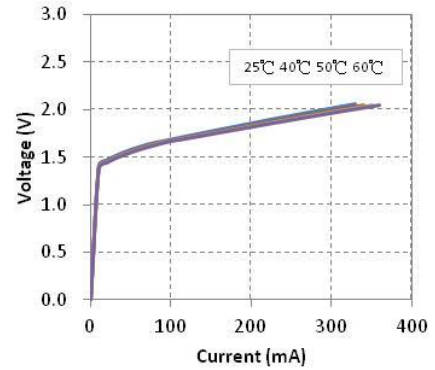
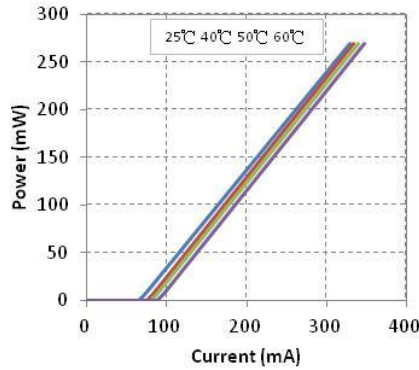

For reference only. Contents above are subject to change without notice.