

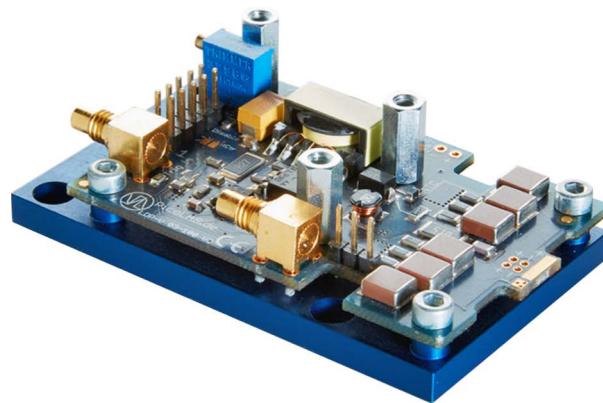

User Manual

LDP-V 03-100 V4.0



Rev. 1910

Table of Contents

Product Overview	3
Important Information	4
How to get started	5
How to connect the LDP-V 03-100	6
Operating Range Diagram.....	7
Maximum Duty Cycle vs. Output Current	8
Current Droop vs. Pulse Duration.....	8
Typical Performance of the LDP-V	8
Internal Structure of the LDP-V	9
How to use the internal HV-DC Supply	10
Pulse Output.....	10
Trigger Input.....	10
Trigger Output Monitor	11
Absolute maximum Ratings.....	12
Mechanical Details of the Baseplate	12

Germany and Other Countries

Laser Components Germany GmbH
Tel: +49 8142 2864-0
Fax: +49 8142 2864-11
info@lasercomponents.com
www.lasercomponents.com

France

Laser Components S.A.S.
Tel: +33 1 39 59 52 25
Fax: +33 1 39 59 53 50
info@lasercomponents.fr
www.lasercomponents.fr

United Kingdom

Laser Components (UK) Ltd.
Tel: +44 1245 491 499
Fax: +44 1245 491 801
info@lasercomponents.co.uk
www.lasercomponents.co.uk

Nordic Countries

Laser Components Nordic AB
Tel: +46 31 703 71 73
Fax: +46 31 703 71 01
info@lasercomponents.se
www.lasercomponents.se



PicoLAS

FOCUSSING POWER TO THE POINT

LDP-V 03-100 V4.0

Driver Module for pulsed Lasers

Rev. 1910

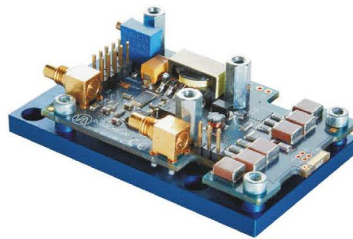

- Compact OEM module
- 0.3 to 3 A diode current
- < 1.2 ns rise time
- Pulse width control via SMC trigger input (1 ns to >10 μ s)
- Rep. rates from single shot to 35 MHz
- Single supply
- Current monitor and isolated monitor
- Applications: LIDAR, Measurements, Ignition, Ranging, Biochemistry, ...

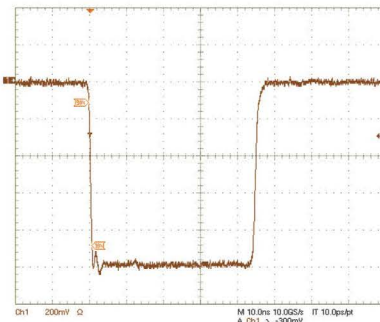

Figure: Current monitor output, scale: -0.4 A/Div

Technical Data*

Output current	0.3 .. 3 A (max. 3.5 A)**
Max. output voltage	80 V
- int. high voltage	0 .. 80 V, 1 A, 15 W
Rise time	Typ. 800 ps, max. 1.2 ns
Trigger delay	Typ. 2.5 ns, max. 4 ns
Min. pulse duration	1 ns
Max. pulse duration	> 10 μ s**
Trigger range	Single shot to 35 MHz** (refer to diagram with operating limits)
Trigger input	5 V into 50 Ω via SMC-jack
Trigger output	Galvanically isolated Rogowski coil
Current monitor	2.0 A / V into 50 Ω
Supply voltage	15 .. 24 V DC, 2.2 A
Max. power dissipation	15 W
Dimensions in mm	75 x 44 x 20
Weight	76 g
Operating temperature	-20 to +55 $^{\circ}$ C

* Measured into a short instead of laser diode. Technical data is subject to change without further notice.

** See manual for detailed information.

Product Description

The LDP-V 03-100 is a small and inexpensive source for nanosecond pulses. The device is optimized for pulse repetition from single shot up to MHz repetition with duty cycles up to 100%** . Its typical application is driving pulsed laser diodes. Those can be mounted directly onto the LDP-V, eliminating the need for strip lines. The diode must be electrically isolated from earth (chassis) ground. Compatible packages: TO-18, TO-5, TO-52, 5,6 mm, 9 mm and similar.

Despite its small size, the LDP-V is designed for ease of use. It eliminates the need for multiple peripheral supply units. A single 15.. 24 V DC supply and a triggering signal are all what is required for operation.

Additionally, the LDP-V can be extended with the PLCS-21 controller to enable USB 2.0 communication with a PC or the operating unit PLB-21.

Do not use PLCS-21 with higher supply voltage than 15 V. If you use the PLCS-21 with higher voltage than 15 V, the device will be damaged.

PicoLAS strongly recommends the use of the PLCS-21 to achieve best results.

Optional Accessories: PLCS-21
PLB-21
LDP-V BOB
LDP-V KIT

Important Information

With respect to version 4.0, we performed the following changes compared with the versions 3.3 or older:

- 1) There is no option to provide an external HV-DC voltage to the board. Pin 2 of the main pin header is out of function. Please use the internal HV; it is powerful enough for all parameters.
- 2) The trigger signal can only be provided via the SMC connector. Pin 6 of the pin header has got no connection. If you use a PLCS-21 due to the very high speed signals, you will need a SMC-SMC cable. This will be shipped free of charge upon request (one for each PLCS-21).
- 3) The maximum internal high voltage is reduced to be max. 80 V. If the voltage is displayed with a PLCS-21 via a PLB-21 operation unit or a PC interface it will show 100 V at a real internal setting of 80 V. Please interpret this as 100 % and scale all values accordingly. This is done to keep a backward compatibility to all previously delivered PLCS-21 devices. The max. current of 3 A will be achieved below 75 V.

How to get started

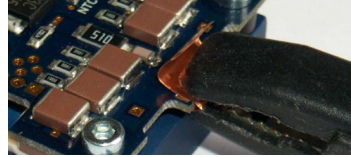
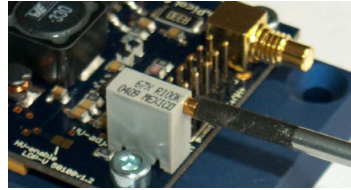
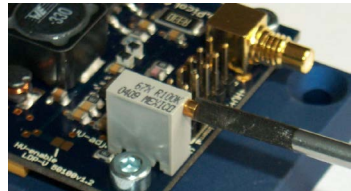
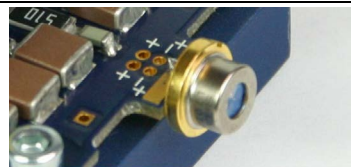
Step	What to do	Check
1	Unpack your device.	
2	Make a short at the output.	
3	Turn the high voltage to the lowest value (turn poti fully counterclockwise).	
4	Connect a pulse source with the desired pulse width to the selected triggering input.	E.g. 100 ns, 100 Hz replate.
5	Connect your scope.	Select 50 Ohm termination, trig on neg. falling edge, 200 mV/div.
6	Apply the supply voltage. Security advice: Do not touch any leads of the output or the output capacitors as they are connected to a high voltage of up to 100 V.	Connect a 15 .. 24 V DC power supply to the pin header. See page 5 for details. Note: Some supplies have a voltage overshoot during turn on/turn off. This may damage the device.
7	Adjust the value of the desired pulse current (turn the poti clockwise until the current reaches the desired level).	
8	Disconnect the supply, remove the short at the output and assemble the laser diode (polarity!).	
9	Reconnect the supply and check the optical output of your laser diode.	Note: The actual current is always some percent lower than the value of step 7. Adjust the current with help of the poti.

Do not use PLCS-21 with a higher supply voltage than 15 V. If you use the PLCS-21 with higher voltage than 15 V the device will be damaged.

How to connect the LDP-V 03-100

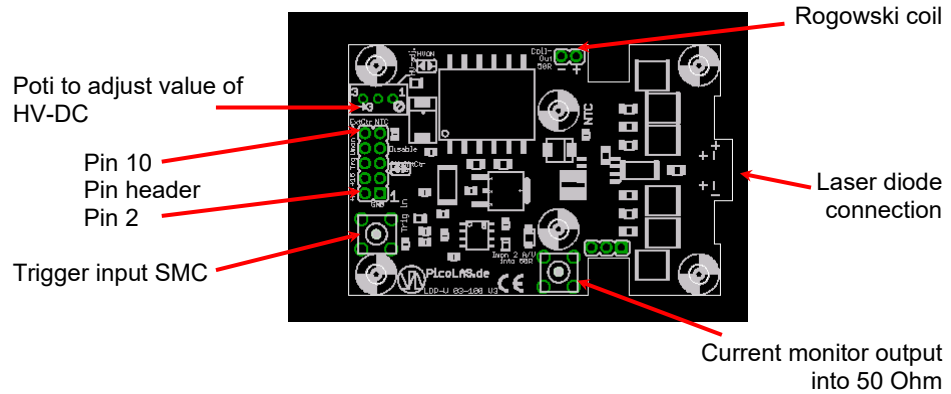

Connections via Pin header:

Pin	Name	Description
1	GND	Ground return
2	Currently not used	Do not use
3	GND	Ground return
4	+15 V	Supply voltage, connect to a power supply
5*	Disable_Poti	Disables the internal HV setpoint poti when set high
6	Pulse_In	Trigger input into 50 Ohm
7	Disable	Not connected
8*	U-Monitor	High voltage monitor output (scale: 40 mV/V) for supervising the actual high voltage
9	NTC	Internal 10 kOhm NTC versus GND for temperature monitoring (B-value: 3620)
10*	Currently not used	Do not use

Trigger Input:

The trigger input requires a signal level of 5 V and is terminated with 50 Ohm.

Current Monitor Output:

The current monitor output has a scale of 2 A/V with a negative signal output. It has a source impedance of 50 Ohm and must be terminated with 50 Ohm to achieve the correct scale.

Laser Diode Connection:

The laser diode can either be connected via the mounting holes on the top side of the pulser (inner hole: anode, outer hole: cathode) or at the rectangular pads on top (anode) and bottom (cathode) of the pulser.

Security Advice: Do not touch any leads of the output or the output capacitors as they are connected to a high voltage of up to 100 V.

Do not use PLCS-21 with higher supply voltage than 15 V. If you use the PLCS-21 with higher voltage than 15 V, the device will be damaged.

Operating Range Diagram

LDP-V 03-100: Max. rebrate vs. pulse width (internal HV, with cooling)

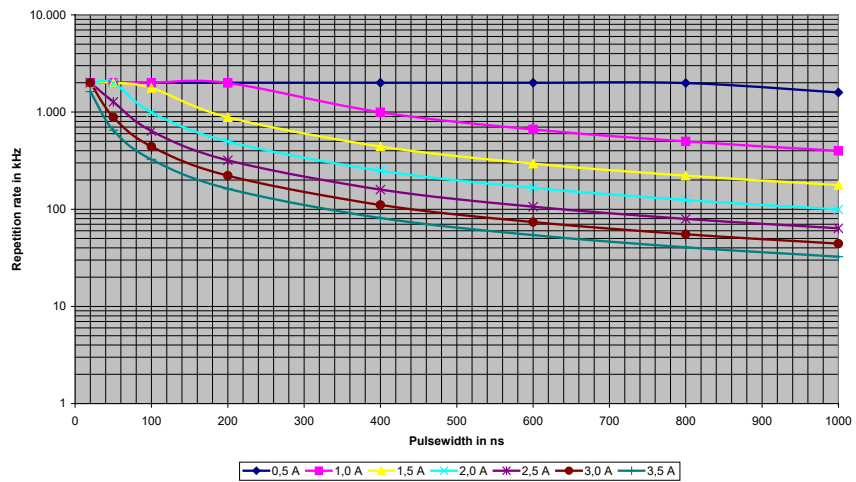

LDP-V 03-100: Max. rebrate vs. pulse width (internal HV, without cooling)

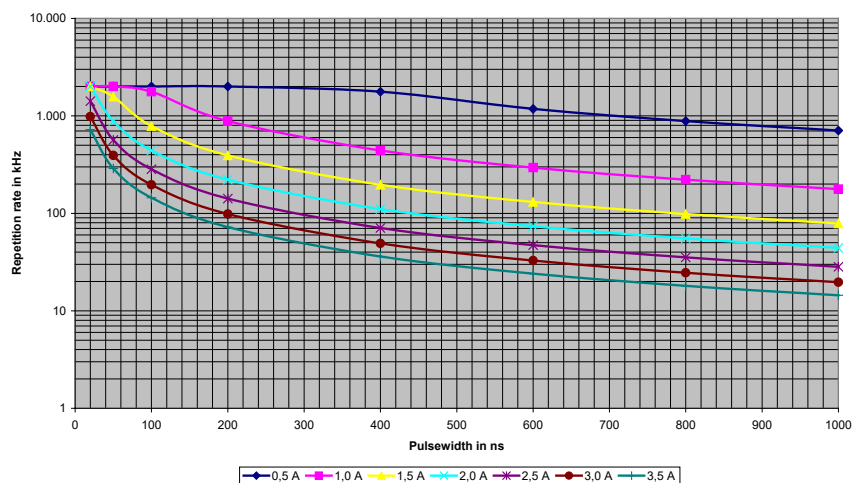

Maximum Duty Cycle vs. Output Current

The following tables show the maximum allowable duty cycle depending on a given output current.

With active cooling of the baseplate:

Output current in A	Typical high voltage in V	External displayed HV in V	Max. duty cycle with int. HV
0.5	12.7	15.9	1.00
1.0	24	30	0.40
1.5	35.3	44.1	0.18
2.0	46.6	58.2	0.10
2.5	57.9	72.4	0.06
3.0	69.2	86.5	0.04
3.5	80	100	0.03

Without cooling of the baseplate:

Output current in A	Typical high voltage in V	External displayed HV in V	Max. duty cycle with int. HV
0.5	12.7	15.9	1.00
1.0	24	30	0.40
1.5	35.3	44.1	0.18
2.0	46.6	58.2	0.10
2.5	57.9	72.4	0.06
3.0	69.2	86.5	0.04
3.5	80	100	0.03

Current Droop vs. Pulse Duration

The table below shows the absolute output current droop (in A) versus pulse length. Pulse durations shorter than one microsecond are not considered as the droop is typically lower than 1%.

Current in A	Pulse duration in μ s		
	1	5	10
0.3	<1%	<1%	<1%
1.0	<1%	<1%	0.012 A
2.0	<1%	0.024 A	0.056 A
3.0	0.024 A	0.054 A	0.088 A

Typical Performance of the LDP-V

The table below shows the typ. achieved pulse performance using different pulse sources.

Signal source	Typ. output rise time (0 .. 2 A)	Typ. output rise time (2 .. 3 A)
Rectangular pulse signal (<100 ps rise time)	900 ps	1.1 ns
PLCS-21 with SMC-SMC trigger cable	900 ps	1.8 ns
PLCS-21 on top of the driver	920 ps	2.7 ns
Low performance signal generators	> 5 ns	> 5 ns

Internal Structure of the LDP-V

The LDP-V series generates the pulses by a simple but efficient principle. First, the storage capacitors (C_s) are charged, whether through the internal HV-DC supply or an external high voltage source. When a pulse is applied at the trigger input, the high speed mosfet opens and the current flows from the capacitor through the laser diode, mosfet and current sense resistors. At the end of the pulse the mosfet closes again and the current stops. The generated current depends on the applied high voltage, the laser diode compliance voltage and its differential resistance.

The following formula gives a good estimation of the laser diode current depending on the pulser's high voltage supply U_{HV} , the laser diode compliance voltage U_{comp} and its differential resistance R_{diff} :

$$I_{LD} \approx \frac{U_{HV} - U_{comp}}{23.6 + R_{diff}}$$

The laser diode current is measured with current sensing resistors (current monitor output) and with the galvanically isolated Rogowski coil. The trigger input provides full control of the driver's pulsing capability to the user. The required DC high voltage can either be applied through an external voltage source or it can be generated with the integrated HV-DC supply. The internal supply is controlled by the HV setpoint poti. A voltage monitor (pin 8) provides feedback of the high DC voltage.

The Diode D_{RP} prevents the laser diode from reverse currents; a 10kR NTC provides the possibility to monitor the pulser temperature. An overtemperature protection is NOT integrated on the driver.

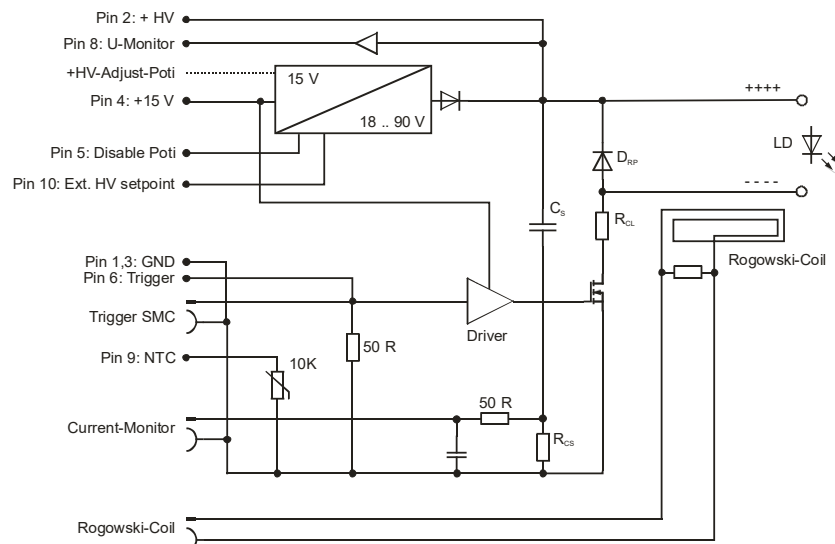

How to use the internal HV-DC Supply

The LDP-V series provides a high power (up to 15 W / 1 A / 80 V) internal high voltage supply. To adjust the laser diode current to the desired value follow the steps below.

Note: Make sure that the solder junction is done to activate the HV-DC supply.

1. Turn the poti fully counterclockwise
2. Apply the 15 .. 24 V supply voltage
3. Start pulses
4. Measure the diode current
5. Adjust the level of the high voltage supply (hence the level of the current) by turning the poti clockwise

Security Advice:

Do not touch any leads of the output or the output capacitors as they are connected to a high voltage of up to 80 V.

Pulse Output

The LDP-V series provides ultra rapid pulse rise and fall times in the region of several nanoseconds. However, pulse rise and fall depend on the parasitic stray inductance of the cabling to the laser diode. Direct connection without any kind of wires to the module is absolutely necessary for best results. For detailed information about the effect of the laser diode connection on the pulse shape please refer to PicoLAS Application Notes "Impedance of Diodes" and "LD-Connections".

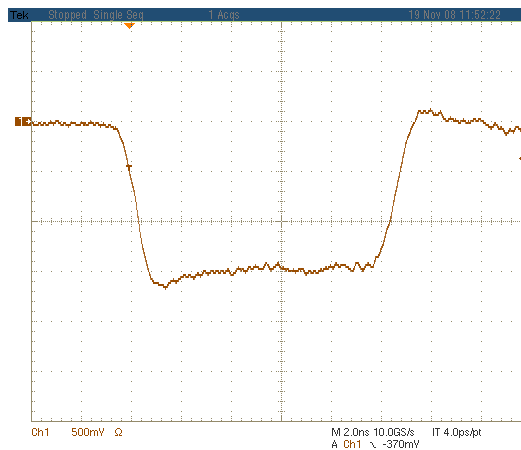

Typical pulse rise and fall times of LDP-V 03-100 (scale: 1 A/Div)

Trigger Input

The trigger input, both on the pin header and the SMC jacket, is terminated with 50 Ohm to ground. The trigger source has to be able to provide a signal level of 5 V with a 50 Ohm load.

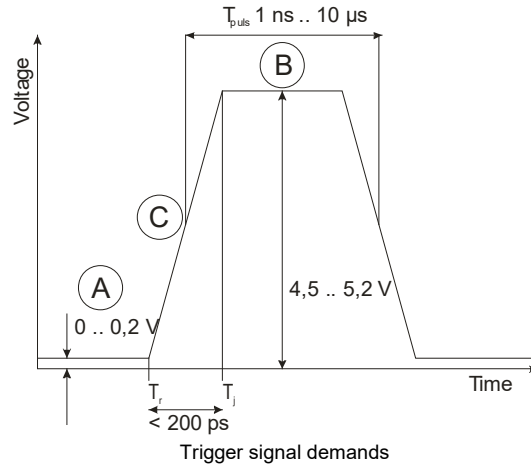

Notes:

- A: Exceeding 0.2 V during pulse pause will cause a non proper turning off and thermal damage.
- B: If the trigger altitude is below 4.5 V the device will not turn on properly and can not carry the full current. Exceeding 5.2 V can damage the power stage and will yield in μ s-trailing after turn off.
- C: To achieve best rise times the rise time of the trigger must be as short as possible. Shortest pulse durations are guaranteed with rise times below 200 ps. There is no "Schmitt-Trigger" inside the LDP-V 03-100.

Trigger Output Monitor

The trigger output signal is generated with an integrated, isolated Rogowski coil and provides an ultra fast galvanically isolated signal. The signal shape is proportional to the derivative of the load current. It can be used for a current response triggering signal and has no delay to the load current. Combined with an integrator it is possible to use this signal for a galvanically isolated current monitor. The isolation barrier is suitable for voltages up to 100 V and prevents unwanted ground loops.

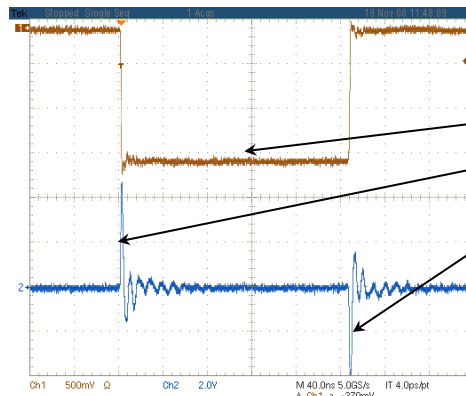

- Signal of the Rogowski coil:
- "True" load current
- Positive edge at pulse begin
- Negative edge at pulse end

Absolute maximum Ratings

Supply voltage range: 12 .. 26 V
 Max. output current U-monitor, NTC: 1 mA
 Input voltage range Disable_Poti: 0 .. 5 V
 Input voltage range trigger input, disable: 0 .. 15 V

Security Advice:

Do not touch any leads of the output or the output capacitors as they are connected to a high voltage of up to 80 V.

Mechanical Details of the Baseplate

All dimensions in millimetres.

