



PDINV300 Series 300 Micron InGaAs Detectors for Fiber Optics

PD-LD Inc. offers a variety of standard and custom PIN Photodiodes and APDs in fiber coupled packages. The semiconductors offered are of proven manufacture and design. Our Silicon devices cover the optical spectrum from 400 to 1100nm, InGaAs is optimal from 1100 to 1650nm and Germanium is suitable from 800 to 2100nm. All devices are available in fiber pigtailed co-axial packages or in connector style receptacle packages.

Pigtailing

Devices can be pigtailed with any size optical fiber that is compatible with its active area size. Pigtails may range in core size from 3um to 100micron. One meter is the standard length, but any length or connector termination may be specified. Pigtails may be terminated

Receptacles

Standard ST, FC and SC housings are available in both panel and board mountable versions. These receptacles can be optimized for use with both single mode and multimode optical fibers.

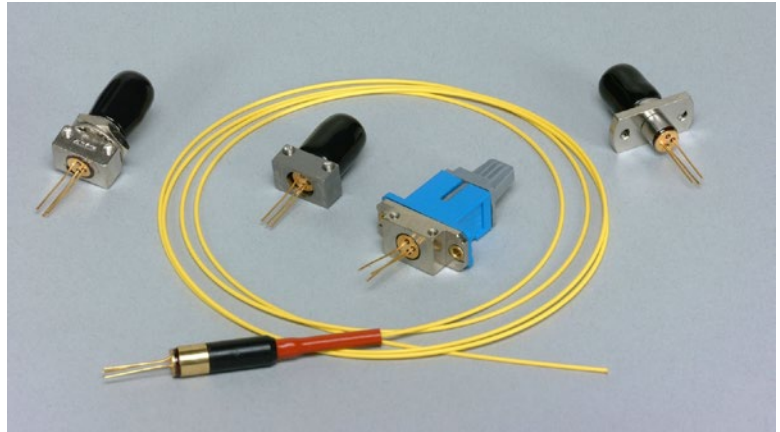

Low Back Reflection Assemblies

For those applications requiring low optical back reflection, PD-LD offers a series of fiber pigtailed InGaAs detectors. Typically, 55 um or 75um InGaAs detectors are aligned to angle-polished, radially tuned fiber pig-tails, in order to minimize incident reflected light. With this process, back reflection values from -40 to -50dB may be specified. Such devices are ideal for CATV, tap monitor and high speed digital applications.

Manufacturing

PD-LD Inc. maintains a large inventory of the most popular detector sizes and pin-outs. Efficient package designs and manufacturing processes allow PD-LD to rapidly support both small and large volume requirements. Complete 100% testing of all critical parametric device values ensure optimal performance and quality. Not all receptacle packaging styles are represented on this data sheet, so please contact PD-LD for specific needs.

PD-LD Part Number	Active Area (µm)	Responsivity (A/W) Min.	Capacitance Typ. Max	Dark Current Typ. Max	Bandwidth -3dB (MHz)	Pin-Out
InGaAs (@ 5V bias, 1300nm Laser Source, 25°C)						
PDINV300FC11-M-0	300	0.85	4.2 4.4	0.5 5.0	600	W
PDINV300FC21-M-0	300	0.85	4.2 4.4	0.5 5.0	600	W
PDINV300SC63-M-0	300	0.85	4.2 4.4	0.5 5.0	600	W

PD-LD Inc. reserves the right to make modifications to or discontinue products without prior notice.

1-15 PDIND RevB

PDINV300 Series 300 Micron InGaAs Detectors for Fiber Optics

Pinout

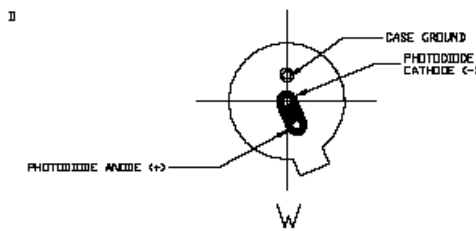

Pigtailed	Receptacle
P DXXKAAAFCCB-O-V-M	PDXXKAAACCCF-O-V

Device Type XX	Device Code K	Active Area AAA	Fiber Size F (µm)	Connector CC Pigtail Only	Receptacle CCC	Bracket B Pigtail Only	Orienta- tion O	Pigtail Length M
IN=InGaAs PIN	V	300=300microns	1=9/125/900	FC=FC/PC	FC1=Panel Mount	A=None	M	10=10m
			2=50/125/900	FA=FC/APC	FC2=Board Mount	B=102-10112 Panel	03=3m	
			3=62.5/125/900	SC=SC/PC	ST7=Low profile	C=102-10181 BdMt	01=1m	
			4=100/140/900	SA=SC/APC	ST8=High profile	D=102-10198 BdMt	.5=0.5m	
			9= customer supplied	ST=ST/PC	SM1=SMA Board Mount	W=Bracket Shipped Separately	.1=0.1m	
			A=200/240/900		SC6= SC Board Mount	X=Customer Supplied		
			D=105/125/900					
			M=6.2/125/900 1060-XP Fiber 6.2um MFD at 1060nm					

PD-LD Inc. reserves the right to make modifications to or discontinue products without prior notice.

1-15 PDIND RevB

PDINV300 Series 300 Micron InGaAs Detectors for Fiber Optics

FC Board Mount Receptacle with M Orientation

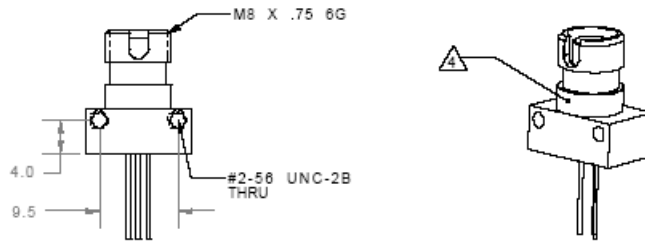

Key Slot at 12:00 and Ground at 9:00 for M orientation

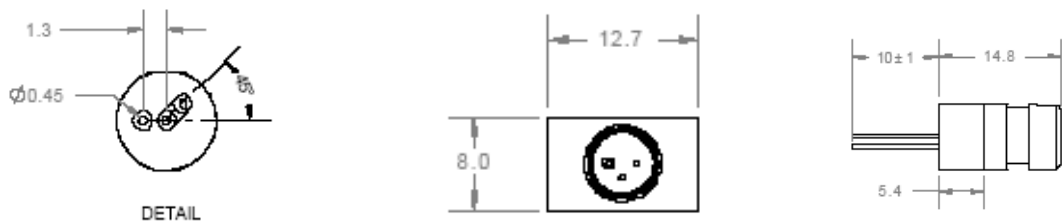

SC6 Style Board Mountable Receptacle with "M" Lead Orientation

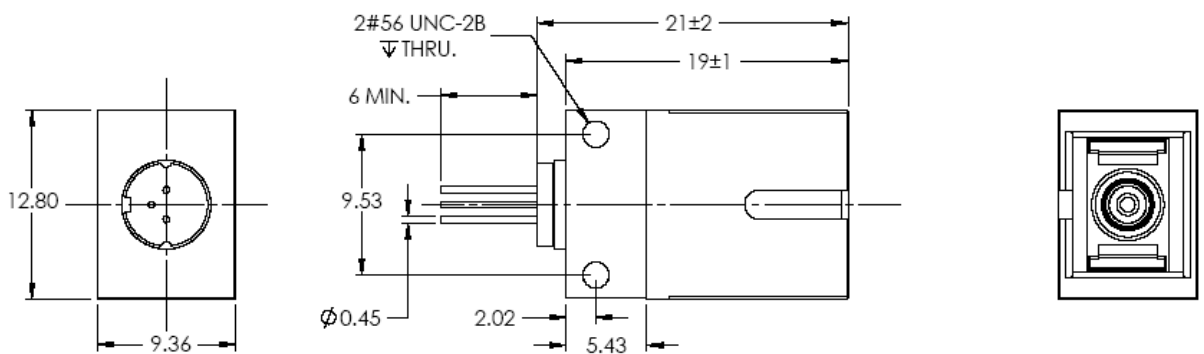

PD-LD Inc. reserves the right to make modifications to or discontinue products without prior notice.

1-15 PDIND RevB

PDINV300 Series 300 Micron InGaAs Detectors for Fiber Optics

PDINV300FC11-M-0
FC Vertical/Panel Mount Style receptacle
(Please note "W" pin-out would apply)

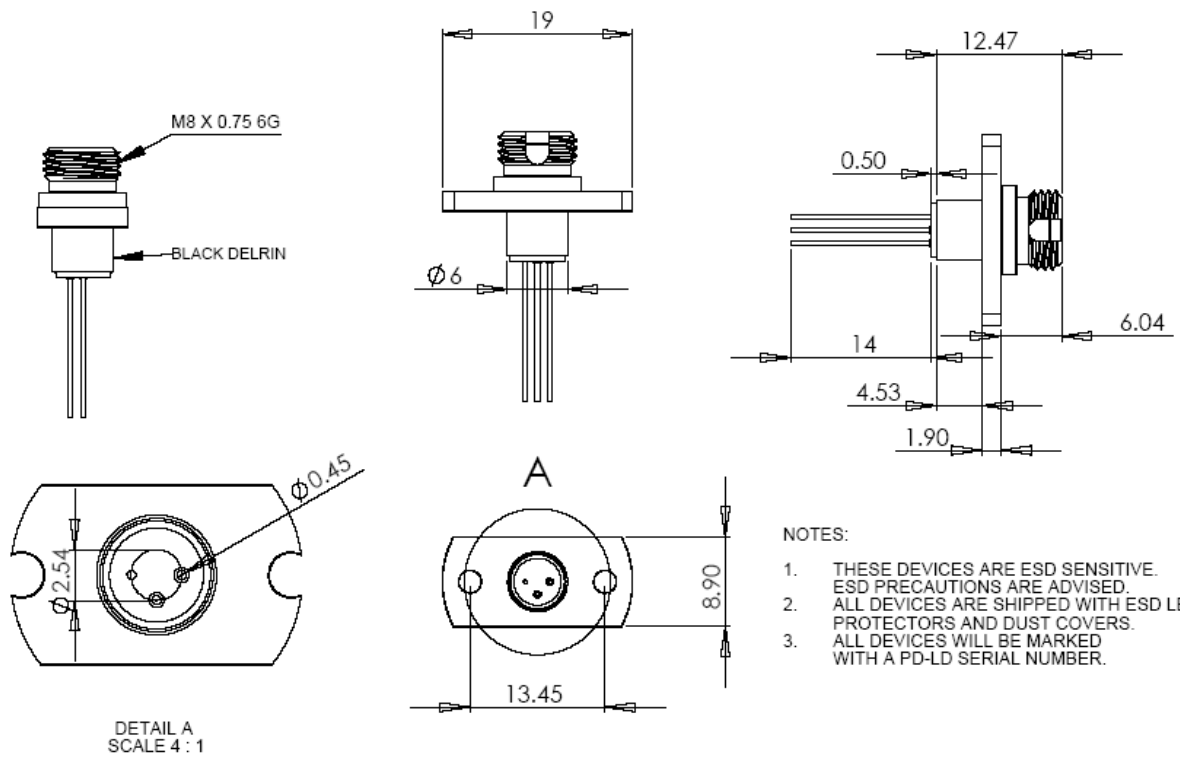

PD-LD Inc. reserves the right to make modifications to or discontinue products without prior notice.

1-15 PDIND RevB

PDINV300 Series 300 Micron InGaAs Detectors for Fiber Optics

Parameter	Min	Max	Unit
Forward Current	-	25	mA
Reverse Current	-	5000	uA
Reverse Voltage	-	20	V
Optical Input Power	-	10	mW
Operating Case Temperature	-40	85	C
Storage Temperature	-40	85	C
Soldering Temperature (10 seconds)		250	C

PD-LD Inc. reserves the right to make modifications to or discontinue products without prior notice.

1-15 PDIND RevB

PDINV300 Series 300 Micron InGaAs Detectors for Fiber Optics

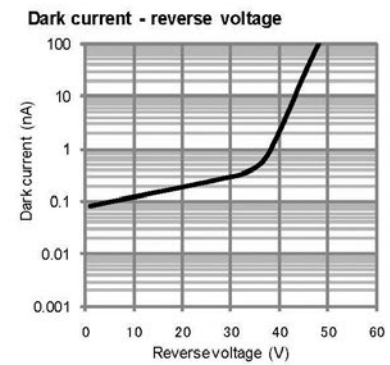
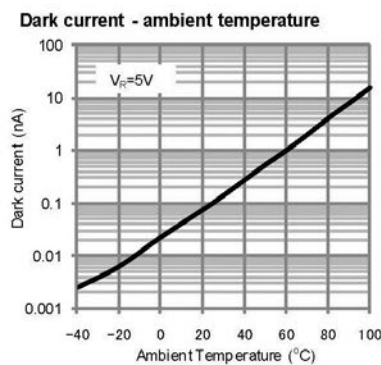
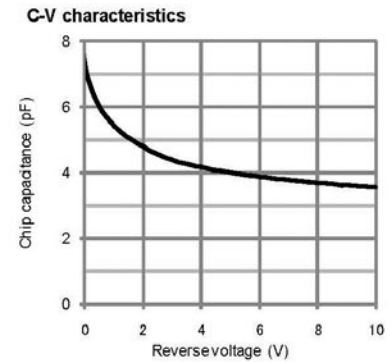
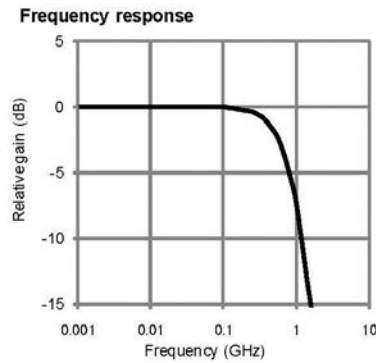
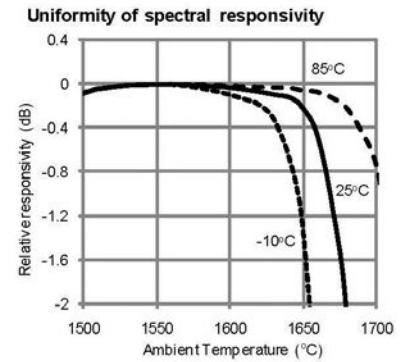
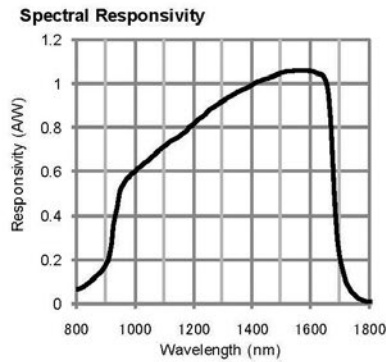

PD-LD Inc. reserves the right to make modifications to or discontinue products without prior notice.

1-15 PDIND RevB

03/16 / V3 / PIM / pd_ld/ingaaspinpd300um