

FLEXPOINT® DOE Series Laser Modules with Diffractive Optical Elements

With the help of diffractive optical elements (DOEs) it is possible to turn a simple laser dot into a variety of different beam patterns. LASER COMPONENTS offers a wide range of different patterns as crosses, parallel lines, dot lines, dot matrix and many more. The DOEs can be integrated into our standard FLEXPOINT® laser modules.

Features

- Huge variety of different patterns
- Red or green laser
- Adjustable or preset focus
- Choice of small or ruggedized housing



Applications

- Machine vision
- Measurement tasks
- Alignment, pointing and positioning
- Medical, Biophotonics

Standard (small) Housing

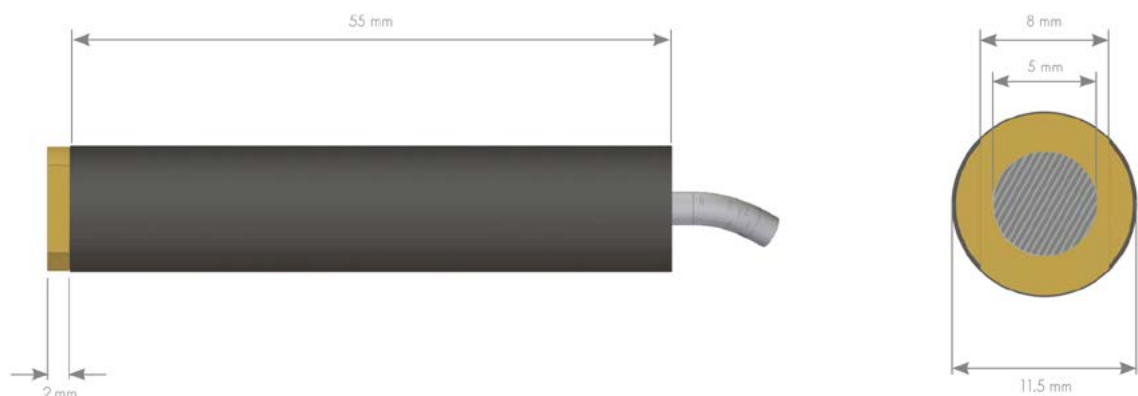

Ruggedized Housing

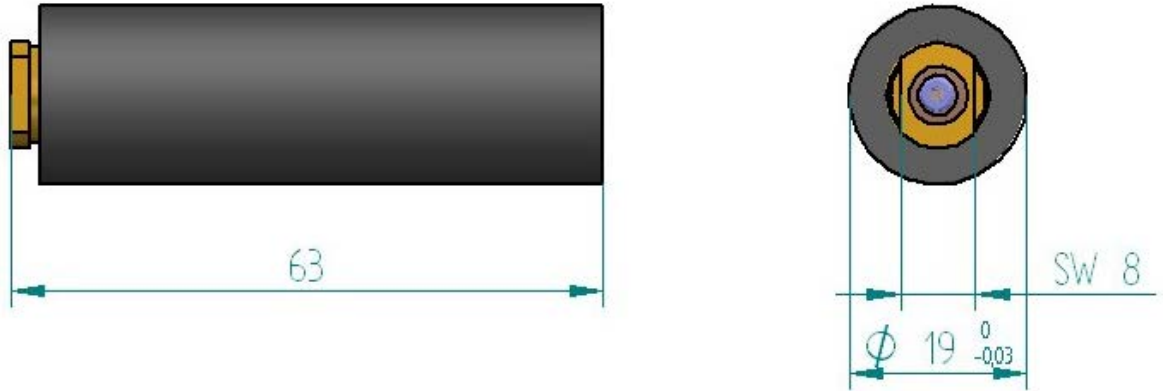

Laser Module Specifications

Wavelength	405 nm - 905 nm
Output power	From < 1 mW up to 100 mW, depending on wavelength
Power stability	Better +/- 5% (after warm up)
Bore sighting	< 0.5° (improved bore sighting on request)
Pointing stability	< 50 µrad/°C
Focussing options	Adjustable focus / focus preset
Focussing range	100 mm to collimation (shorter focussing range on request)
Operating voltage	4.5 – 6 VDC, reverse voltage protection (4.5 – 30 VDC as option), 10 - 30 VDC for 520 nm, 405 nm, 450 nm
Power consumption	30 – 250 mA, depending on laser type
Operating temperature	0 – 50 °C (depending on used laser type, temperature range can be extended or limited)
Storage temperature	-10 °C to +60 °C
Housing size	Standard: 57 mm length, 11.5 +0/-0.03 mm diameter Ruggedized: 63 length, 19.0 +0/-0.3 mm
Housing materia	Black anodized aluminium, isolated (potential free)
Cable length	2.0 m
Options	Power adjustment by external potentiometer Power adjustment by control wire (0 – 5 V; active low) Digital modulation up to 10 kHz (0 – 5 V; active low), higher freq. on request Different housing style
Accessories	Mount, power supply, laser safety eyewear

Ordering Code FLEXPOINT® DOE Series

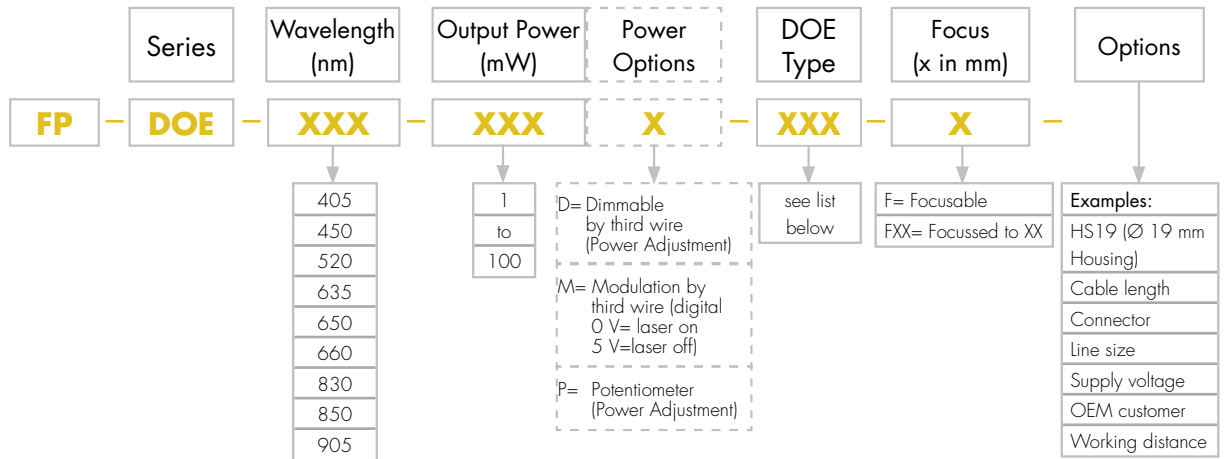

DOE as Add-on

Beside the integrated DOE laser module it is possible to mount a DOE on a dot laser module with elliptical beam.



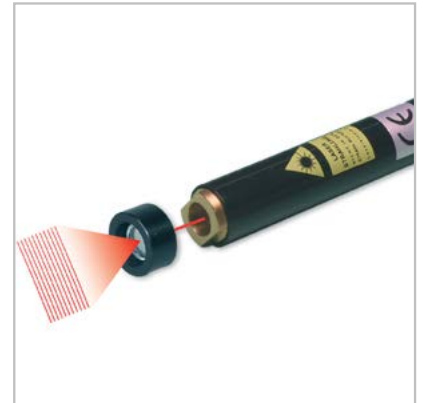



All DOE's can be used with FLEXPOINT® laser modules with 11.5 mm diameter removable in a black plastic cap for multi-use with different laser modules.

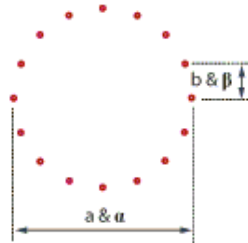

List of available DOEs





Circles & Dot Circles



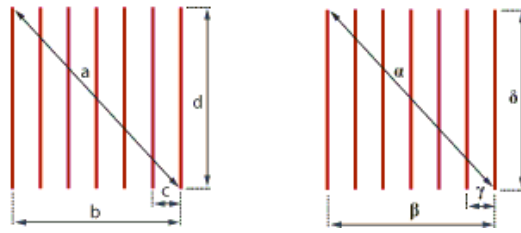

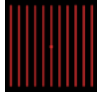
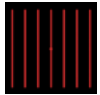

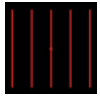
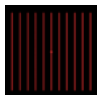

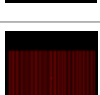
DOE Item #	Description	Design Wavelength	Optimum Wavelength Range	Pattern Size @ 100 mm Distance (@ Design Wavelength Values: mm)		Pattern Angles (@ Design Wavelength)		Image
				a	b	α	β	
DOE-219	Solid Line Circle	592 nm	480 - 600 nm	55.8	-	31.2°	-	
DOE-220	1:16 Dot Circle	515 nm	480 - 532 nm	81.9	16.1	44.5°	9.2°	
DOE-221	1:72 Dot Circle	532 nm	400 - 570 nm	36.9	1.6	20.9°	0.9°	
DOE-229	1:36 Dot Circle	532 nm	480 - 560 nm	6.1	0.5	3.5°	0.3°	
DOE-238	Solid Line Circle	520 nm	520 - 532 nm	6.0	-	3.4°	-	
DOE-240	1:16 Dot Circle	635 nm	530 - 700 nm	18.9	3.7	10.8°	2.1°	
DOE-268	Solid Line Circle	488 nm	488 - 532 nm	77	-	42.1°	-	

Multi Lines











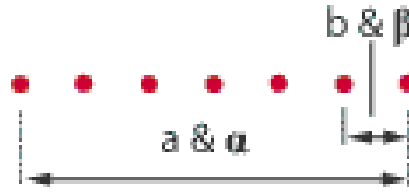

DOE Item #	Description	Design Wavelength [nm]	Optimum Wavelength Range [nm]	Pattern Size @ 100 mm Distance (@ Design Wavelength Values: mm)				Pattern Angles (@ Design Wavelength)				Image
				a	b	c	d	α	β	γ	δ	
DOE-213	11 Lines (Square)	635	530 - 670	76.3	54.1	5.4	54.1	41.8°	30.3°	3°	30.3°	
DOE-233	7 Lines (Square)	635	530 - 670	54	38.2	6.4	38	30°	22°	3.6°	22°	
DOE-250	5 Lines (Rectangular)	660	590 - 670	55	10.9	2.7	53.9	30°	6°	1.5°	30°	
DOE-251	7 Lines (Rectangular)	650	590 - 730	15.2	8.8	1.47	12.3	8.7°	5.1°	0.84°	7°	
DOE-252	5 Lines (Square)	635	530 - 670	43	30	7.5	30	24°	17.2°	4.3°	17.2°	
DOE-253	11 Lines (Square, Thin Lines)	635	530 - 670	76	54	5.4	54	42°	30°	3°	30°	
DOE-254	25 Lines (Square)	660	530 - 670	68.4	48.3	2.0	48.3	37.7°	27.2°	1.1°	27.2°	
DOE-255	65 Lines (Square, Central Line Thicker)	660	530 - 670	45.6	32.2	0.5	32.2	25.7°	18.3°	0.3°	18.3°	
DOE-284	41 Lines (Rectangular)	660	600 - 700	133.4	104.0	2.6	78	67.4°	54.9°	1.4°	42.6°	

Multi Lines





DOE Item #	Description	Design Wavelength [nm]	Optimum Wavelength Range [nm]	Pattern Size @ 100 mm Distance (@ Design Wavelength Values: mm)				Pattern Angles (@ Design Wavelength)				Image
				a	b	c	d	α	β	γ	δ	
DOE-348	10 Lines (Rectangular)	650	600 - 700	125.1	90.0	10.0	87.5	64.2°	48.5°	5.4°	47.3°	
DOE-350	15 Lines (Rectangular)	520	480 - 550	65.5	42.1	3.0	50.2	36.3°	23.8°	1.7°	28.2°	
DOE-381	11 Lines (Rectangular)	850	830 - 880	155.6	41.5	4.15	150	75.8°	23.5°	2.3°	74.0°	
DOE-386	3 Lines (Rectangular)	520	490 - 550	50.7	8.0	4.0	50.0	28.4°	4.6°	2.3°	28.1°	
DOE-387	5 Lines (Rectangular)	520	480 - 560	50.7	8.0	2.0	50.0	28.4°	4.6°	1.15°	28.1°	
DOE-391	81 Lines (Rectangular)	650	600 - 700	156.0	124.8	1.6	93.6	75.9°	63.9°	0.8°	50.2°	
DOE-392	3 Lines (Rectangular)	660	600 - 700	54.7	10.8	5.4	53.6	30.6°	6.2°	3.1°	30.0°	

Lines & Dot Lines











DOE Item #	Description	Design Wave-length [nm]	Optimum Wavelength Range [nm]	Pattern Size @ 100 mm Distance (@ Design Wavelength Values: mm)		Pattern Angles (@ Design Wavelength)		Image
				a	b	α	β	
DOE-263	1:5 Dot Line	635	450 - 700	10.5	2.6	6°	1.54°	
DOE-264	1:9 Dot Line	670	630 - 780	1.6	0.2	0.9°	0.1°	
DOE-265	1:19 Dot Line	650	500 - 540, 630 - 690	24	1.3	13.7°	0.8°	
DOE-266	QC-Line -5 @633	633	630 - 690	8.7	-	5°	-	
DOE-267	QC-Line - 30 @532	532	470 - 560	53.8	-	30.1°	-	
DOE-281	1:11 Dot Line	650	600 - 730	28.9	2.9	16.5°	1.6°	
DOE-282	1:99 Dot Line	660	600 - 700	33.7	0.3	19.1°	0.2°	
DOE-283	QC-Line - 20 @633	633	630 - 670	35	-	20°	-	
DOE-286	QC-Line - 30 @660	660	600 - 700	54.6	-	30.5°	-	

Lines & Dot Lines









DOE Item #	Description	Design Wavelength [nm]	Optimum Wavelength Range [nm]	Pattern Size @ 100 mm Distance (@ Design Wavelength Values: mm)		Pattern Angles (@ Design Wavelength)		Image
				a	b	α	β	
DOE-287	QC-Line - 45@660	660	600 - 700	83.9	-	45.5°	-	
DOE-337	1:99 Dot Line	635	600 - 700	49.3	0.5	27.7°	0.3°	
DOE-364	QC-Line - 45@940	940	890 - 980	83.0	-	45.0°	-	
DOE-369	QC-Line - 36@640	639	600 - 700	65.0	-	36.0°	-	
DOE-383	QC-Line - 51@840	840	790 - 880	95.0	-	50.6°	-	

Crosshair











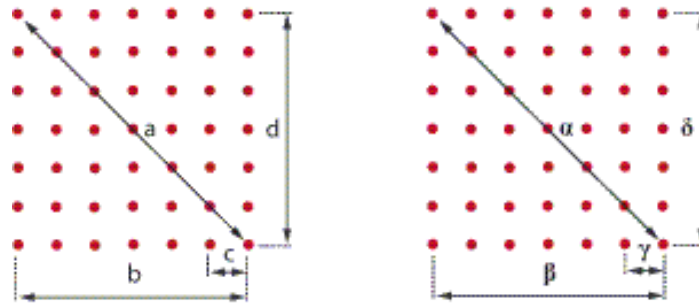

DOE Item #	Description	Design Wave-length [nm]	Optimum Wavelength Range [nm]	Pattern Size @ 100 mm Distance (@ Design Wavelength Values: mm)		Image
				a	α	
DOE-205	Cross - 5@650	650	580 - 660	8.7	5°	
DOE-212	Cross - 25@532	532	500 - 640	45.1	25.4°	
DOE-214	Cross - 2@645	645	600 - 645	3.4	2°	
DOE-218	Cross - 15@640	640	500 - 640	26.3	15°	
DOE-239	Cross - 5@520	520	488 - 600	8.7	5°	
DOE-245	Cross - 10@633	633	570 - 690	17.6	10°	
DOE-246	Cross with surrounding high contrast area	633	530 - 670	17.5	10°	
DOE-247	Cross - 25@645	645	600 - 800	44.3	25°	
DOE-248	Cross - 37@645	645	630 - 700	66.8	37°	

Crosshair







DOE Item #	Description	Design Wave-length [nm]	Optimum Wavelength Range [nm]	Pattern Size @ 100 mm Distance (@ Design Wavelength Values: mm)	Pattern Angles (@ Design Wavelength)	Image
				a	α	
DOE-249	Cross - 45@633	633	620 - 700	83	45°	
DOE-270	Cross - 30@640	640	590 - 660	53.6	30°	
DOE-280	Cross - 60@635	635	580 - 690	115.5	60°	
DOE-289	Cross - 15@520	520	480 - 550	26.4	15°	
DOE-340	Cross - 60@450	450	420 - 520	116.1	60.3°	
DOE-342	Cross - 52@515	515	440 - 540	97.6	52°	
DOE-299	Cross - 75@650	650	600 - 700	153.5	75.0	
DOE-382	Cross - 30@450	450	440 - 480	53.6	30.0	

Dot Matrix











DOE Item #	Description	Design Wavelength [nm]	Optimum Wavelength Range	Pattern Size @ 100 mm Distance (@ Design Wavelength Values: mm)				Pattern Angles (@ Design Wavelength)				Image
				a	b	c	d	α	β	γ	δ	
DOE-206	17 x 17 Dots	660	590 - 730	38	26.6	1.7	26.6	21.5°	15.2°	0.9°	15.2°	
DOE-223	2 x 2 + 1 Dots	635	635 + 405	28	19.9	19.9	19.9	16.1°	11.4°	11.4°	11.4°	
DOE-231	101 x 101 Dots	660	635 - 680	12.8	9.1	0.1	9.1	7°	5°	0.05°	5°	
DOE-241	21 x 21 Dots	635	560 - 730	11.9	8.4	0.4	8.4	6.8°	4.8°	0.2°	4.8°	
DOE-242	16 x 16 Dots	635	530 - 730	12.4	8.8	0.6	8.8	7.1°	5°	0.3°	5°	
DOE-243	17 x 17 Dots	635	550 - 720	12.4	8.8	0.5	8.8	7.1°	5°	0.3°	5°	
DOE-244	13 x 13 Dots	635	590 - 670	7.4	5.3	0.4	5.3	4.3°	3.0°	0.3°	3.0°	
DOE-257	51 x 51 Dots	660	560 - 720	56.9	40.3	0.8	40.3	31.8°	22.8°	0.5°	22.8°	
DOE-258	11 x 11 Dots	635	590 - 690	71	50	5	50	39°	28°	2.8°	28°	









Dot Matrix

DOE Item #	Description	Design Wavelength [nm]	Optimum Wavelength Range	Pattern Size @ 100 mm Distance (@ Design Wavelength Values: mm)				Pattern Angles (@ Design Wavelength)				Image
				a	b	c	d	α	β	γ	δ	
DOE-339	6 x 6 Dots	635	590 - 690	11.7	8.3	1.7	8.3	6.7°	4.7°	0.9°	4.7°	
DOE-351	10 x 10 Dots	532	510 - 600	21.1	14.9	3.3	14.9	23.8°	17°	1.9°	17°	
DOE-352	4 x 6 Dots	532	500 - 580	26.6	13.7	4.6	22.8	15.1°	7.8°	2.6°	13.6°	
DOE-353	5 x 5 Dots	690	630 - 750	1.1	0.75	0.19	0.75	0.61°	0.43°	0.11°	0.43°	
DOE-388	51 x 51 Dots	532	480 - 600	46.8	33.1	0.66	33.1	26.4	18.8	0.38	18.8	
DOE-389	21 x 21 Dots	520	480 - 600	46.8	33.1	1.66	33.1	26.4	18.8	0.95	18.8	







Special Pattern

DOE Item #	Description	Design Wavelength [nm]	Optimum Wavelength Range	Pattern Size @ 100 mm Distance (@ Design Wavelength Values: mm)	Pattern Angles (@ Design Wavelength)	Image
DOE-236	Solid Line Square	633	530 - 650	Width: 63.1 Height: 63.1 Diagonal: 89.5	Width: 35° Height: 35° Diagonal: 48.2°	
DOE-256	Square Grid 51 x 51 Lines	660	530 - 660	Width: 40.3 Height: 40.3 Diagonal: 56.9 Line Spacing: 0.8	Width: 22.8° Height: 22.8° Diagonal: 31.8° Angle betw. Lines: 0.45°	
DOE-259	5 Rings	545	530 - 700	Width: 51 Line Spacing: 5.1	Width: 29° Line Spacing: 2.8°	
DOE-269	10 Rings	515	488 - 532	Width: 96.2 Line Spacing: 4.8	Width: 51.4° Line Spacing: 2.6 °	
DOE-285	Hexagon	780	520 - 800	Width: 13.1	Width: 7.5°	
DOE-354	SquareGrid 10 x 10 Lines	658	620 - 680	Width: 72.8 Height: 72.8 Diagonal: 102.9 Line Spacing: 8.1	Width: 40° Height: 40° Diagonal: 51.4° Angle between Lines: 4°	
DOE-396	21 x 11 Hexagonal Array	660	580 - 730	Width: 61.1 Height: 35.3 Diagonal: 70.5 Line Spacing: 3.5	Width: 34.0° Height: 20.0° Diagonal: 38.8° Angle between Dots: 2.0°	
DOE-397	11 x 10 Hexagonal Array	660	580 - 730	Width: 44.4 Height: 46.2 Diagonal: 64.1 Line Spacing: 5.1	Width: 25.1° Height: 26.0° Diagonal: 35.5° Angle between Dots: 2.9°	

Random Dot Patterns

DOE Item #	Description	Design Wavelength [nm]	Optimum Wavelength Range	Pattern Size @ 100 mm Distance (@ Design Wavelength Values: mm)	Pattern Angles (@ Design Wavelength)	Image
DOE-332	33000-Dot Pseudo-Random Pattern	830	820 - 850	Width: 114.6 Height: 76.3 Diagonal: 136.9	Width: 59.6° Height: 41.7° Diagonal: 68.8°	
DOE-335	33000-Dot Pseudo-Random Pattern (46°x32° @650nm)	645	630 - 660	Width: 84.8 Height: 56.4 Diagonal: 101.3	Width: 45.9° Height: 31.5° Diagonal: 53.7°	
DOE-372	40100-Dot Pseudo Random Pattern	850	825 - 870	Width: 114.9 Height: 72 Diagonal: 135.6	Width: 59.7° Height: 39.6° Diagonal: 68.3°	
DOE-373	31806-Dot Truly-Random	830	800 - 890	Width: 146.9 Height: 118.5 Diagonal: 86.9	Width: 72.6° Height: 61.3° Diagonal: 47.0°	
DOE-374	47708-Dot Truly-Random	830	800 - 890	Width: 146.9 Height: 118.5 Diagonal: 86.9	Width: 72.6° Height: 61.3° Diagonal: 47.0°	
DOE-375	29594-Dot Pseudo Random Pattern	830	810 - 850	Width: 118.5 Height: 86.5 Diagonal: 146.7	Width: 61.3° Height: 46.8° Diagonal: 72.5°	
DOE-384	51978-Dot Truly-Random	640	610 - 660	Width: 97.5 Height: 130.4 Diagonal: 162.8	Width: 52.0° Height: 66.2° Diagonal: 78.3°	
DOE-385	101050-Dot Truly-Random	640	610 - 660	Width: 100.4 Height: 133.9 Diagonal: 167.4	Width: 53.3° Height: 67.6° Diagonal: 79.9°	

Viewfinder

DOE Item #	Description	Design Wavelength [nm]	Optimum Wavelength Range	Pattern Size @ 100 mm Distance (@ Design Wavelength Values: mm)	Pattern Angles (@ Design Wavelength)	Image
DOE-215	Viewfinder	645	570 - 750	Width: 27.0 Height: 17.7 Diagonal: 32.0	Width: 15.5° Height: 10.1° Diagonal: 18.2°	
DOE-234	Viewfinder (Lines Square)	633	590 - 730	Width: 61.0 Height: 61.0 Diagonal: 86.0	Width: 34° Height: 34° Diagonal: 47°	
DOE-260	Viewfinder (Circle + Cross)	645	570 - 750	Width Cross: 37.0 Circle Ø: 18.3	Width Cross: 21° Circle Ø: 10.5°	
DOE-261	Viewfinder (Dot Circle + Cross)	635	570 - 750	Width Cross: 11.0 Circle Ø: 8.8 Dot Spacing: 1.1	Width Cross: 6.3° Circle Ø: 5° Angle betw. Dots: 0.63°	
DOE-262	Viewfinder (Dot Square)	532	480 - 670	Width: 12.3 Height: 12.3 Diagonal: 17.4 Dot Spacing: 0.5	Width: 7° Height: 7° Diagonal: 10° Angle betw. Dots: 0.3°	
DOE-288	Viewfinder	650	590 - 730	Width: 83.0 Height: 53.7 Diagonal: 98.9	Width: 43.7° Height: 27.9° Diagonal: 52.6°	
DOE-345	Viewfinder (Circle + Cross)	520	500 - 540	Width Cross: 49.9 mm Circle Ø: 24.6 mm	Width Cross: 28.0° Circle Ø: 14.0°	
DOE-394	Viewfinder	520	500 - 540	Width: 65.9 mm Height: 65.9 mm Diagonal: 93.2 mm	Width: 36.5° Height: 36.5° Diagonal: 50°	