

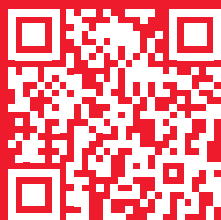

KALIBRIERSERVICE
in Deutschland



**LASER
COMPONENTS**

LASER BEAM MEASUREMENT & BEAM PROFILING

PRODUCT GUIDE 2023

■ POWER ■ ENERGY ■ PROFILING ■ TERAHERTZ

TABLE OF CONTENTS

NEW RELEASES	3	WAVELENGTH MANAGEMENT	119
ABOUT GENTEC-EO	5	UV CONVERTERS	119
POWER DETECTORS	13	IR ADAPTOR	120
LOW POWER	17	FILTERS	121
PH	17	BEAM SIZE MANAGEMENT	122
PRONTO-SI	19	CL	122
UM-B	21	ABSORPTION CURVES	123
XLP12	23	TERAHERTZ DETECTORS	125
GENERAL USE	25	LOW POWER	127
UP10-H	25	THZ-B	127
UP12-H	27	THZ-I-BNC	131
UP17-H/W	29	GENERAL USE	133
UP19-H	31	THZ-D	133
PRONTO	33	SENSORS	135
UP25-H	35	QS-THZ	135
UP55-H	37	ABSORPTION CURVES	137
UP55-HD	39	DISPLAYS & PC INTERFACES	139
HIGH-PERFORMANCE ABSORBERS	41	DISPLAY DEVICES	143
UP19-W	41	MIRO ALTITUDE	143
UP50-W	43	MAESTRO	149
UP16-QED	45	TUNER	153
UP52-QED	47	UNO	155
IS	49	PC INTERFACES	157
HIGH POWER	51	U-LINK	157
HP60	51	S-LINK	159
HP100	53	P-LINK	161
SUPER HP	55	M-LINK	163
HIGH-POWER PRONTO	57	ALL-IN-ONE DETECTORS	165
BD	59	INTEGRA	165
ABSORPTION CURVES	61	PC-GENTEC-EO	166
ENERGY DETECTORS	67	BLU	167
LOW ENERGY	71	CUSTOM / OEM PRODUCTS	169
PE	71	SENSEURS OEM	171
QE-B	73	UD	171
MACH 6	75	DISCRETE PYROS	173
GENERAL USE	79	QS-L & QS-H	174
QE12-MB	79	QS-IF	175
QE25-MB	81	QS-IL	176
QE50-MB	83	DISCRETE PYROS	177
QE65-MB	85	CUSTOM PRODUCTS	179
QE95-MB	87	CUSTOM DESIGN EXAMPLES	179
HIGH SPEED	89	QUAD	183
QE12-MT	89	STEP	187
QE25-MT	91	TRAP	189
QE50-MT	93	ACCESSORIES LIST	191
HIGH ENERGY	95	DISTRIBUTORS WORLDWIDE	193
PRONTO-500-IPL	95	RETURN & WARRANTY	194
CALORIMETERS	97		
ABSORPTION CURVES	101		
BEAM PROFILING	105		
BEAM PROFILERS	107		
BEAMAGE	107		
QUALITY ANALYZERS	111		
BEAMAGE-M2	111		
POWER MANAGEMENT	115		
ND	115		
BA	117		

NEW RELEASES

Featured products

New product



MIRO ALTITUDE

MIRO ALTITUDE is Gentec-EO's new flagship product for reading your laser power and energy measurements. More than an evolution from our current product line, we see it as a revolution in the laser beam measurement industry that helps engineers and technicians increase their productivity thanks to numerous new features in both hardware and software. Enter modern times of laser beam measurement with:

- 10" high-resolution, anti-glare touchscreen
- Remarkably strong and durable aluminium casing
- More connectivity possibilities than ever before: Ethernet, RS-232, GPIO, external trigger, sync out, analog out, USB-C and 2 USB
- 3 display modes: scope chart, needle and bar graph
- Built-in file manager to save and organize your recorded measurement sessions
- Measure up to 10x faster with XNR Anticipation™

■ SUPERCHARGED PROFESSIONAL DISPLAY DEVICE FOR POWER AND ENERGY MEASUREMENT

New product



OPTICAL ATTENUATORS

Our new BA optical attenuators that can withstand up to 1000 W of laser power have many different uses:

- Monitor power and beam profile simultaneously
- Polarization insensitive beam-splitter with no back-reflections
- Optical pick-off for use with our energy or power detectors
- Attenuator for our high sensitivity detectors like M6, PH, etc.

New product



INTEGRATING SPHERE POWER METER

Get the best of both worlds with our new integrating sphere power meters. This technology offers the fast risetime of photodetectors with the high average power of thermal detectors.

- Fast risetime: 0 - 95% in less than 0.2 seconds
- Measures up to 1000 W of continuous power
- Available in 2 sizes: 12 mm or 50 mm Ø aperture
- Integrated signal processing with USB or RS-232 output

■ FAST & ROBUST POWER MEASUREMENT

New product



HIGH-POWER DETECTORS

With its gold reflector cone and tube extension to reduce back-reflections, the HP60A-15KW-GD-TUBE traps up to 99% of the incident radiation, and can handle up to 15 kW of continuous laser power. The very low back-reflections of the detector ensure a safer working environment with high power lasers. This detector can also handle the high intensities of very small beams.

■ HIGH POWER, LOW BACK-REFLECTIONS

NEW RELEASES

Featured products

AWARD-WINNING PRODUCTS

The Laser Focus World Innovators Awards program was developed to recognize the most innovative solutions in optics and photonics products and systems. Gentec-EO is proud that two of our product series have been recently recognized among the best innovative solutions by an esteemed and experienced panel of judges from the optics and photonics community.



FAST, KW-LEVEL POWER MEASUREMENT

With a response time over 20 times faster than any other kilowatt-level power meter on the market, the IS50A-1KW opens up new possibilities for high power laser characterization and control. You can now follow the ramp-up of high-power sources and discern quick changes in laser power.

The IS50A-1KW features:

- An outstanding dynamic range
- Response time lower than 0.2 s
- Low back-reflections
- High damage thresholds

The IS50A-1KW was recognized as an innovative solution for test and measurement in the 2022 Laser Focus World Innovators Awards.

■ THE FASTEST HIGH-POWER DETECTOR ON THE MARKET!



UP-QED SERIES

The UP-QED laser power detectors for extremely high-density lasers were recognized among the most innovative photonics technologies for the 2021 Laser Focus World Innovators Awards, as a GOLD honoree.

The UP-QED series are power detectors for lasers with extreme power and energy density, such as laser micromachining systems. Thanks to a proprietary absorber that diffuses the measured beam and absorbs it in a larger volume, these detectors have the highest damage thresholds on the market.

- Available in 2 sizes: 16 mm or 52 mm Ø aperture
- Our highest maximum average power density
- Our highest maximum energy density

■ THE HIGHEST DAMAGE THRESHOLDS ON THE MARKET!



HP-BLU SERIES

High power measurements in enclosures or hard-to-reach areas are no longer a problem with the BLU wireless output. With the integrated Bluetooth® module, you can grab your laser measurement data at up to 30 m distance from your PC.

The BLU series makes laboratories and production floors safer by allowing the operators to be farther from the detector while making measurements, and with less cables in the workspace, accidents are less likely to happen. They are also essential tools for field service technicians that will take advantage of the integrated electronics, thus carrying less instruments.

■ WIRELESS MEASUREMENT FOR ALL POWER LEVELS

The Bluetooth® word mark and logos are registered trademarks owned by the Bluetooth SIG, Inc. and any use of such marks by Gentec-EO is under license. Other trademarks and the trade names are those of their respective owners.

ABOUT GENTEC-EO

Partners for accuracy



Located in the heart of the Quebec Optical Hub, in beautiful Quebec City, Canada, Gentec Electro-Optics (Gentec-EO) has a long history in the laser measurement field. With a track record of over 50 years of innovation and providing quality solutions for laser power and energy measurement applications from the factory to the hospital and laboratory, Gentec-EO stands ready to serve you now and in the future.



MILESTONES

The first laser energy meter in the world has been initially developed for internal use as Gentec Inc. were putting the first high repetition rate TEA CO₂ lasers on the market in 1970. Gentec, Inc. introduced the first pyroelectric joulemeters shortly after that. They were also the first to manufacture both thermopile wattmeters and pyroelectric joulemeters. In the mid 1990's, Gentec introduced the WB series with an average power density damage threshold of 100 kW/cm² that is still unrivalled today. In 2000, Gentec Electro-Optics, Inc. was formed from Gentec, Inc. so that the focus was entirely on laser measurement. And in 2010, the acquisition of Spectrum Detector Inc. allowed Gentec-EO to cover new markets, like THz detectors, ultrafast pyroelectric detectors and highly sensitive photodetectors, to name a few.

OUR ESSENCE

The decision of adopting "PARTNERS for ACCURACY" as our branding slogan is the result of a long evolution that spanned over more than 50 years. It came to us naturally since it represents our very essence. We have always aspired to be more than a simple supplier of state-of-the-art laser measurement technologies. We truly believe that developing a very close partnership with our customers is essential and beneficial for every party. By definition, "partnership" means "aiming at the same goal" and "working together". This is what is driving us. As for "accuracy", it does not solely refer to the precise measurements we are able to provide, but also to the complete understanding of our customers' needs and expectations. Finally, the key to our success is to focus all our energy into "rigor". No matter what the situation, Gentec-EO is always proud to offer its customers the most accurate laser measurements as well as the most personalized help for the development of custom products and solutions.

Let us be your **PARTNERS for ACCURACY**.

gentec-EO
PARTNERS for ACCURACY

WORLDWIDE PRESENCE

Gentec-EO has an evergrowing presence everywhere around the world. We currently have partners in over 40 countries, and each year, we keep adding new partners. We also have a strong presence in most of the European and Asian countries and we now have offices in USA and in Japan. When you send a unit to us for repair or recalibration, you are entitled to expect your unit back in as short a time as possible.

With calibration centers on 3 continents, and offices in Canada, USA and Japan, Gentec-EO has a solid presence and fast turnaround times, just what you need to keep pace with today's rapid market.



HIGHEST CALIBRATION STANDARDS

Measuring with Gentec-EO accuracy

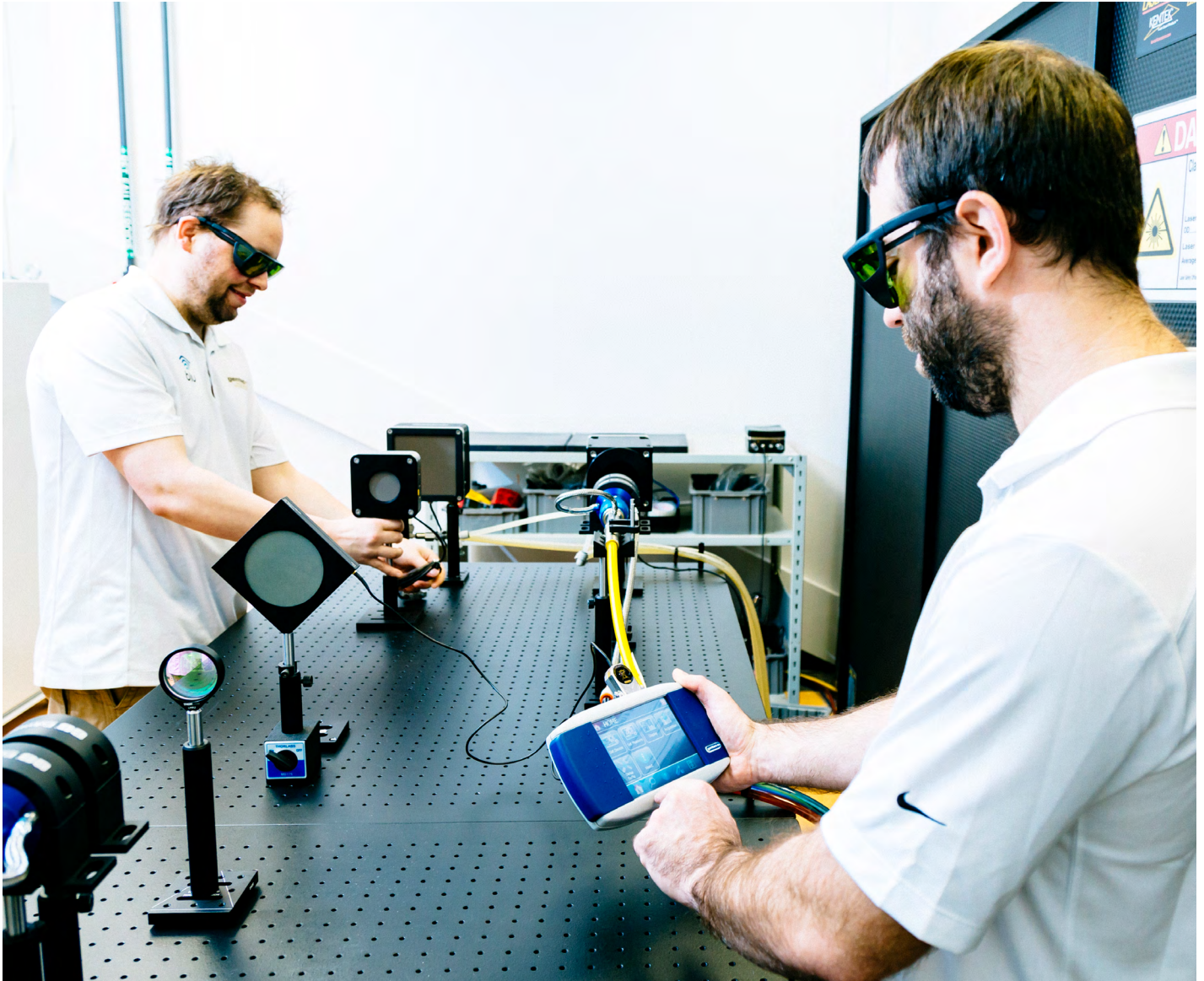

At Gentec-EO, we understand that the essence of our business since over 50 years has been delivering accuracy. There are no half measures: it either measures accurately or it doesn't. This is why one of our company's values is rigor, because our customers expect nothing less.

THE GENTEC-EO ADVANTAGE



We use only **GOLD Calibration Standards**, guaranteeing our customers the lowest calibration uncertainty possible



For each detector that we calibrate, **50 Parameters are collected and logged** in our ISO-certified quality system



The calibration reference is checked 2 to 3 Times during EACH calibration process

Our uncertainty values are based on **Proven Statistical Calculation Processes**



Our Personal Wavelength Correction™ (PWC) data offers you **NIST and/or NRC Traceability over the entire range of the detector**

NIST*
Traceable

Each of these steps contributes to the **TOTAL ACCURACY** of your detector



THE TERMS

ACCURACY

The accuracy of a measurement is defined as the closeness of the agreement between the result of a measurement and the true value.

UNCERTAINTY

Uncertainty is a measure of the “goodness” of a result. The definition and concept of uncertainty is a quantitative attribute to the final result of measurement, considering all systematic and random components of all known input quantities.

ERROR

The error on a measurement is the difference between the measurement result and the true value.

REPEATABILITY

The repeatability is the closeness of the agreement between the results of successive measurements under the same conditions of measurements.

REPRODUCIBILITY

The reproducibility is the closeness of the agreement between the results of successive measurements under changed conditions of measurements. This is also defined as “precision under reproducibility conditions”.

PRECISION

The precision of a measurement is defined as the closeness of agreement between independent test results obtained under stipulated conditions.

HIGHEST CALIBRATION STANDARDS

Measuring with Gentec-EO accuracy

THE CALIBRATION PROCESS



THE TECHNIQUE

By definition, calibration is a comparison between measurements, one of a known magnitude or correctness, which is typically called a “gold standard”, and another measurement comparable to the first one. In the calibration process, there are four critical aspects that need to be controlled precisely:

1

COMPARISON PROCESS

The first step in the calibration process is the comparison to a known and traceable standard. At Gentec-EO, we always do this using Gold and not a Silver calibration standards, unlike some of our competitors. This extra carefulness in the comparison process comes from decades of experience in the laser measurement business.

4

CERTIFICATION

Gentec-EO has been using its own control quality system for many years and is now certified ISO 9001:2015 and our calibration laboratory is accredited ISO/IEC 17025:2017. Over and above the quality system certification process, the most important aspect is how rigorously the different steps and parameters are controlled in order to deliver an accurate calibration day after day.

2

GOLD STANDARD

Gentec-EO's gold laser power detector heads are compared to NIST standard calorimeters at different wavelengths, in accordance to the different lasers used to calibrate your own detector heads.

The laser beam has a nominal diameter appropriate for the detector, and is centered on the detector's absorbing surface. The laser energy impinging upon the test instrument is measured concurrently using a NIST standard calorimeter and a calibrated beam splitter. The beam splitter ratio is measured using NIST standard calorimeters. Before the measurements are performed, the test instrument is allowed to reach equilibrium with the laboratory environment. The calibration factor is found by dividing the instrument output reading by the calculated average incident laser power. The calculation is based on the output reading of the NIST standard calorimeters.

3

UNCERTAINTY CALCULATION

At Gentec-EO we offer the best uncertainty on the market, which means more than just giving the customer the lowest uncertainty value. These calculations also need to follow recognized statistical calculation standards, including those given in NIST's Technical Note 1297. Another important parameter to verify, and one that is less known, is the confidence level. At Gentec-EO, we use a very high confidence level of 95%. Like every other step in the calibration process, our uncertainty calculations are done rigorously. We don't aim to give you just the lowest number, whatever its meaning, we rather aim to give you the true value, with the highest confidence possible.

HIGHEST CALIBRATION STANDARDS

Measuring with Gentec-EO accuracy

ELECTRICAL INSTRUMENTS

All of our electrical instruments are calibrated by certified calibration suppliers. They certify that, at the time of calibration, the instruments used for calibration meet or exceed all published specifications and have been calibrated using standards whose calibrations are traceable to the NIST and/or other recognized international standards. The electrical and physical properties of their laboratories meet the highest requirements for ambient temperature, relative humidity and cleanliness. Their equipment is maintained by procedures that meet the requirements of ISO 9001:2015 and ISO/IEC 17025:2017.

THE FACTS

HOW GENTEC-EO CALIBRATES YOUR DETECTOR

Every detector is individually calibrated to the best possible accuracy traceable to NIST standards. Stable laser sources at various wavelengths are used in our calibration process.

UNCERTAINTY

One very common misconception is the absolute value of calibration uncertainty. Be aware that this value is made using a complex statistical method that takes in account ALL the sources of uncertainty that are present in the process. The figure below shows these steps and their respective contribution to the value of uncertainty. As you can see, the manufacturer itself is only one of these sources.

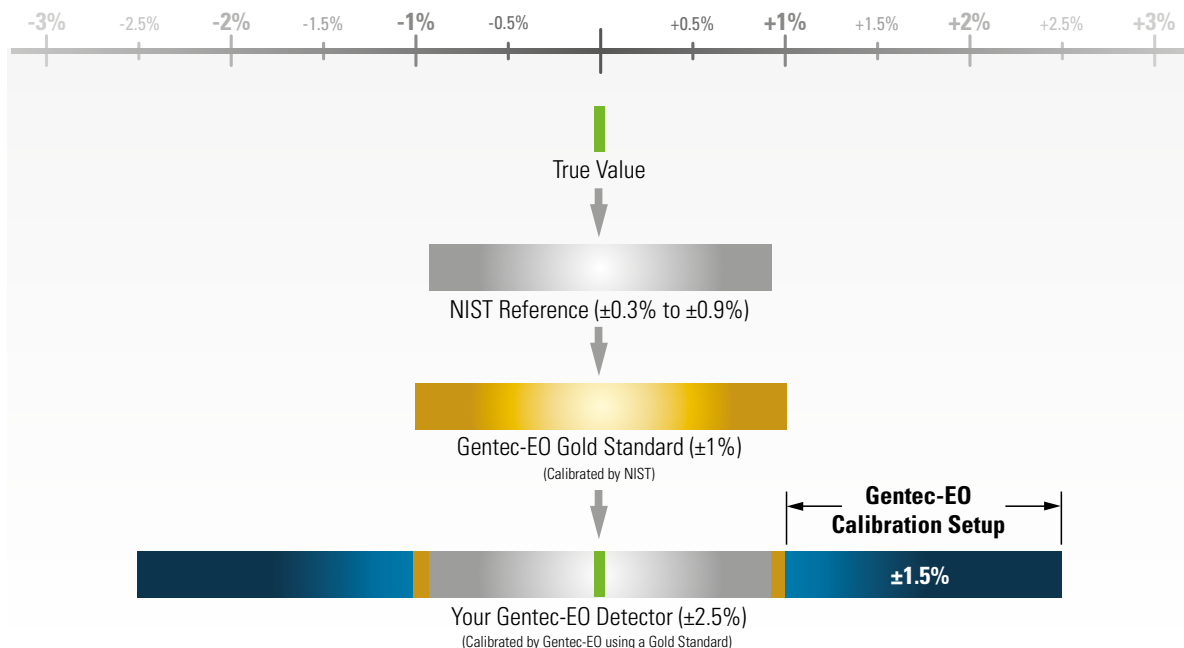

CALIBRATION WAVELENGTHS

Another misconception is that any wavelength can be NIST calibrated. The NIST only supplies references for distinct wavelengths contained between 157 nm (F₂ excimer lasers) and 10.6 μm (CO₂ lasers). Every other wavelength within this range or out of this range is subject to an additional error.

For more information about NIST's calibration wavelengths, please visit their website at: shop.nist.gov/ccrz__ProductDetails?sku=42240C

PERSONAL WAVELENGTH CORRECTION™ CERTIFICATE

To fill the gaps between the NIST references, Gentec-EO offers you the only NIST traceable calibration in nm steps, from 250 nm to 2.5 μm. We achieve this using our proprietary setup that is based on a NIST traceable spectrophotometer. This way, instead of supplying you with typical values, we offer you a NIST traceable calibration. What you get is an overall accuracy that is not more than ± 1% away from the original calibration accuracy, in the calibrated spectral range.

Each Gentec-EO detector comes with a Personal wavelength correction™ Certificate. The correction factors are based on measurements that were made with YOUR detector. They are not based on the general curve of the absorbing material or the general response of equivalent products. This means you get the best wavelength correction tool available on the market. This data is stored in the smart interface of your Gentec-EO detector, you just have to select the wavelength in your display device or PC interface to get the most precise laser measurements on the market.

gentec-EO



Your
Detector Model

Personal wavelength correction™ Certificate

Spectral Absorption Plot measured for: UP55N-40S-H9-D0 Power Detector Serial #299999

Absorption Curve
of your Detector

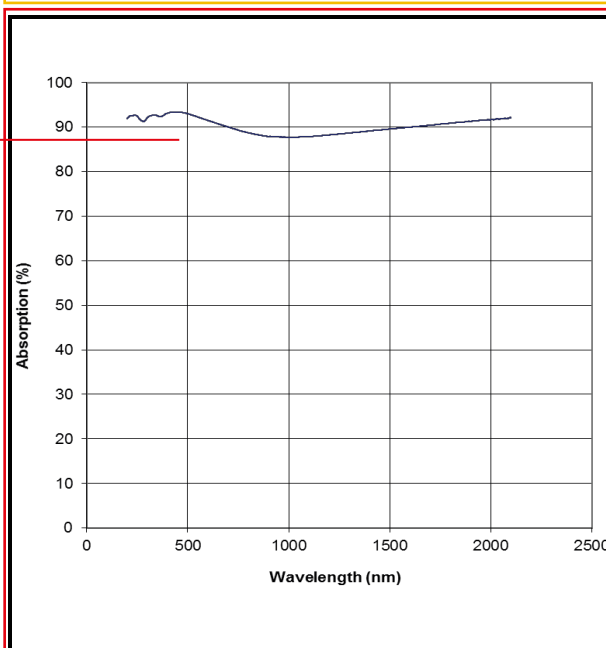

Personal Wavelength Correction™		
Wavelength*** (nm)	Correction	
	Multiplier	Uncertainty
193	0.958	N/A
213	0.950	N/A
248	0.949	± 2.5 %
266	0.958	± 2.5 %
308	0.950	± 1.0 %
337	0.948	± 1.0 %
355	0.949	± 1.0 %
488	0.942	± 1.0 %
514	0.946	± 1.0 %
532	0.949	± 1.0 %
578	0.956	± 1.0 %
632	0.965	± 1.0 %
694	0.974	± 1.0 %
720	0.979	± 1.0 %
810	0.991	± 1.0 %
980	1.000	± 1.0 %
1064*	1.000	N/A
1550	0.978	± 1.0 %
2100	0.953	± 1.0 %
10600**	0.944	N/A

* Calibration wavelength
** Typical value
Adjustment multiplier for wavelength under 248 nm are not traceable.
For Gentec-EO monitors, select the proper wavelength in menu
For other monitors, multiply by the correction multiplier
Power corrected = Power read x correction multiplier
Example: Power (488 nm) = 10mW x 0.942 = 9.42 mW

Wavelength
Correction

- 1 Wavelengths programmed in the EEPROM (nm) (Based on the absorption curve of your detector)
- 2 Calibrated Wavelength (nm) (Using a gold standard)
- 3 Correction factors (Multipliers)

For more info, see Application Note [202184](#) - Understanding your Calibration Certificate.

POWER DETECTORS

Low power measurement

Available with

integra

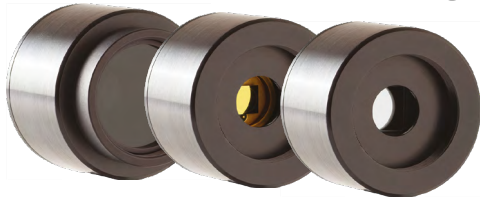

PH: PHOTODETECTORS

- Photodetectors for measurements up to 750 mW
- Available from UV to IR
- Silicon, UV-silicon and germanium sensors
- OD.3/OD1/OD2 attenuators available

■ FAST RESPONSE POWER DETECTORS



PRONTO-SI: ALL-IN-ONE PHOTODETECTOR + METER

- Compact laser power meter up to 800 mW
- 10 x 10 mm aperture
- Integrated OD1 slide-in attenuator
- Color touchscreen display

■ PORTABLE & EASY TO USE



UM: BROADBAND PYROELECTRIC DETECTORS

Our pyroelectric power detectors have the noise level of a photodetector, but with the large bandwidth of a pyroelectric sensor. They have everything you need to accurately measure extremely low powers from the DUV to the FIR.

- 9 mm Ø aperture
- Broadband, flat spectral response
- Very low noise, down to 5 nW

■ MEASURE LOW POWER AT ANY WAVELENGTH

Available with

integra



XLP12: LOW-POWER THERMOPILES

- Low noise level: only $\pm 0.5 \mu\text{W}$
- IR filter available
- Available with volume absorber for short pulses

■ THERMAL POWER DETECTORS WITH LOW NOISE

COMPARISON TABLE - LOW POWER MEASUREMENT

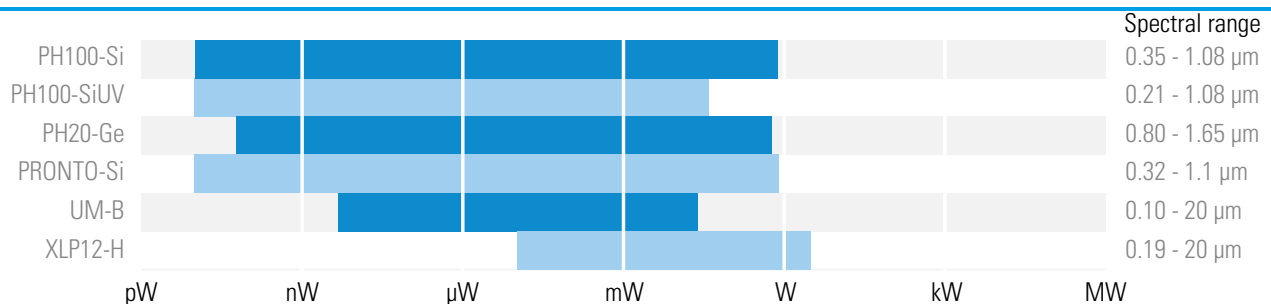

POWER DETECTORS

General use power detectors



UP-H: BROADBAND THERMAL DETECTORS

Our standard absorber offers high damage thresholds and a flat spectral response, making this series of power detectors a versatile solution that can cover most of your laser power measurement needs.

- Available in 6 sizes:

10 mm Ø	12 mm Ø
17 mm Ø	19 mm Ø
25 mm Ø	55 mm Ø
- Available with 5 cooling modules:
 - Convection (S)
 - Small heatsink (H)
 - Large heatsink (L)
 - Fan (F)
 - Water (W)



■ THE WIDEST RANGE OF LASER MEASUREMENTS

PRONTO-250

- Compact laser power meter up to 250 W
- 19 mm Ø aperture
- Color touchscreen display
- Three measurement modes with the PRONTO-250-PLUS model:
 - Single-Shot Power (SSP): up to 250 W
 - Continuous Power (CWP): up to 8 W
 - Single Shot Energy (SSE): up to 25 J



■ PORTABLE & EASY TO USE

COMPARISON TABLE - GENERAL USE POWER DETECTORS

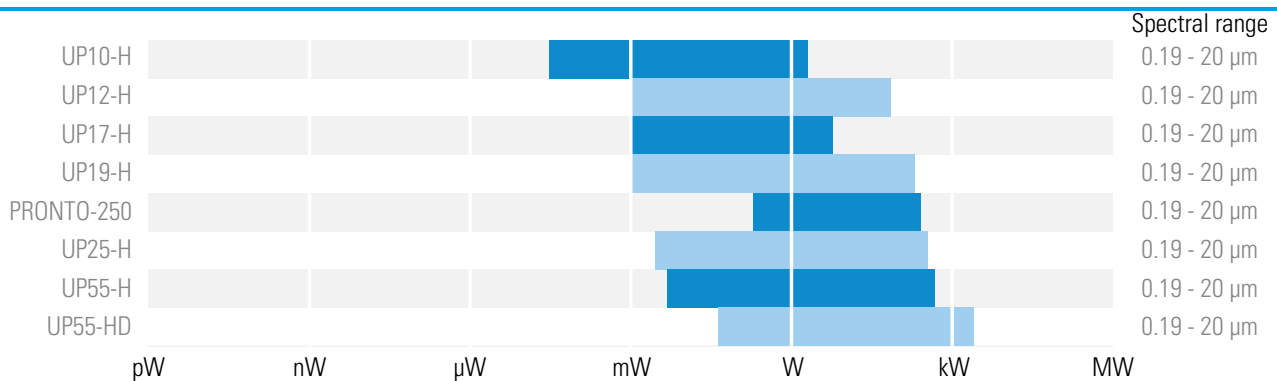

POWER DETECTORS

High performance power detectors

Available with
integra



UP-W

Our "W" absorber can handle tightly focused beams thanks to its extremely high damage threshold for average power density. It can be used to measure up to 50 W, from the UV to IR.

- Available in 2 sizes: 19 mm or 50 mm Ø aperture
- High damage threshold absorber (100 kW/cm²)
- Our highest maximum average power density

■ IDEAL FOR UV LASERS & TIGHTLY FOCUSED BEAMS

Available with
integra



UP-QED

The UP-QED series are power detectors for lasers with extreme power and energy density, such as laser micromachining systems. Thanks to a proprietary absorber that diffuses the measured beam and absorbs it in a larger volume, these detectors have the highest damage thresholds on the market.

- Available in 2 sizes: 16 mm or 52 mm Ø aperture
- Our highest maximum average power density
- Our highest maximum energy density
- Not suitable for UV lasers

■ THE HIGHEST DAMAGE THRESHOLDS ON THE MARKET!

Available with
integra



New product



IS: INTEGRATING SPHERE POWER METER

Get the best of both worlds with our new integrating sphere power meters. This technology offers the fast risetime of photodetectors with the high average power of thermal detectors.

- Fast risetime: 0-95% in less than 0.2 seconds
- Measures up to 1000 W of continuous power
- Available in 2 sizes: 12 mm or 50 mm Ø aperture
- Integrated signal processing with USB or RS-232 output

■ FAST AND ROBUST POWER MEASUREMENT

COMPARISON TABLE - HIGH PERFORMANCE POWER DETECTORS

Model	Power Range	Spectral range
UP17-W	0.19 - 10 μm	0.19 - 10 μm
UP19-W	0.19 - 10 μm	0.19 - 10 μm
UP50-W	0.19 - 10 μm	0.19 - 10 μm
UP16-QED	0.27 - 2.5 μm	0.27 - 2.5 μm
UP52-QED	0.27 - 2.5 μm	0.27 - 2.5 μm
IS12	0.34 - 1.1 μm	0.34 - 1.1 μm
IS50	0.34 - 1.1 μm	0.34 - 1.1 μm

Power Range: pW, nW, μW, mW, W, kW, MW

POWER DETECTORS

High power measurement

New product



Available with



HP60: HIGH POWER, LOW BACK-REFLECTIONS

The gold reflector cone of the HP60 series is specifically designed to handle the high intensities of very small beams. By reflecting the incident light on the sides of the aperture, the cone effectively spreads the intensity on a larger area, thus raising the damage threshold to 10 kW/cm² at the full power (15 kW).

- FOR SMALL BEAMS UP TO 15 KW



Available with



HP100/125: LARGE APERTURE, COMPACT DEVICE

The HP100A and HP125A are the smallest in our HP series of high-power detectors. They are versatile high-power detectors that measure up to 15 kW of continuous power with a noise level of only a few watts. These models feature a very large aperture of 100 or 125 mm Ø.

- CONTINUOUS POWER MEASUREMENT UP TO 15 KW



Available with



SUPER HP: CUSTOM, HIGH-POWER MEASUREMENT

Our unique high-power design allows for infinite customization capabilities. Do not hesitate to contact us with your specific needs. Our Super HP models feature a USB output for direct measurements on a PC as well as our standard DB15 connector. Wireless output is also available.

- CUSTOM SOLUTIONS FOR UP TO 150 KW



PRONTO: PORTABLE HIGH-POWER PROBES

When you are on the go and water cooling is not easily accessible, the PRONTO high-power probes are the best solution. These all-in-one power meters with touchscreen controls come in 4 models: 500 W, 3 kW, 6 kW and 10 kW. Their integrated display is encased in a rugged metallic casing to withstand the harshest of environments.

- UP TO 10 KW WITHOUT WATER COOLING

COMPARISON TABLE - HIGH POWER MEASUREMENT

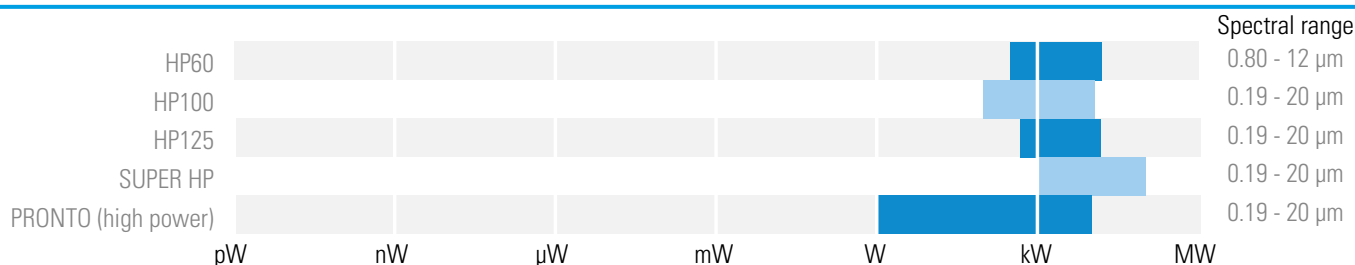

PH

10 pW to 750 mW, Si and Ge sensors



KEY FEATURES

- > **LARGE APERTURES**
10 mm Ø for the silicon sensors
- > **3 VERSIONS**
 - Silicon: 350 - 1080 nm, up to 750 mW
 - Silicon-UV: 210 - 1080 nm, up to 38 mW
 - Germanium: 800 - 1650 nm, up to 500 mW
- > **CHOICE OF ATTENUATORS**
 - OD0.3: 50% transmission (for PH100-SIUV only)
 - OD1: 10% transmission
 - OD2: 1% transmission
- > **HIGH ACCURACY**
The PH100-SI-HA presents the lowest calibration uncertainty to date
- > **PRECISE CALIBRATION**
Wavelength selection in 1 nm steps

OD ATTENUATORS

OD attenuators sold in option. When bought together, the detector is calibrated with and without the attenuator.



PH series detector with OD attenuator

OUTPUT OPTIONS

- > **SMART DB15 CONNECTOR**
Contains all the calibration data
- > **integra ALL-IN-ONE-METER**
Connects directly to a PC
Two models available:
 - USB output (-INT)
 - RS-232 output (-IDR)

COMPATIBLE DISPLAYS & PC INTERFACES



MIRO ALTITUDE



MAESTRO



TUNER



UNO



U-LINK and P-LINK



M-LINK

ACCESSORIES



Stand with delrin post



Extension cables
(4, 15, 20 or 25 m)



Fiber adaptors & connectors
(FC, SC, ST and SMA)



OD attenuators





Pelican carrying case

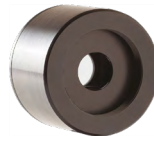

Isolation tube



	PH100-SI-HA-DO	PH100-SIUV-DO	PH20-GE-DO
MAX AVERAGE POWER* (ALONE / WITH MAX ATTENUATION)	36 mW / 750 mW	4 mW / 38 mW	30 mW / 500 mW
EFFECTIVE APERTURE	10 mm ϕ	10 mm ϕ	5 mm ϕ
MEASUREMENT CAPABILITY			
Calibrated spectral range	350 - 1080 nm	210 - 1080 nm	800 - 1650 nm
With OD0.3	---	210 - 1080 nm	---
With OD1	400 - 1080 nm	400 - 1080 nm	900 - 1650 nm
With OD2	630 - 1080 nm	---	950 - 1650 nm
Maximum measurable power*	36 mW at 1064 nm	4 mW at 532 nm	30 mW at 1064 nm
With OD0.3	---	16 mW at 300 nm	---
With OD1	300 mW at 1064 nm	38 mW at 532 nm	300 mW at 1064 nm
With OD2	750 mW at 1064 nm	---	500 mW at 1064 nm
Noise equivalent power^a	10 pW at 980 nm	10 pW at 850 nm	60 pW at 1550 nm
Rise time (nominal)	0.2 s	0.2 s	0.2 s
Calibration uncertainty	± 5.0% (350 - 399 nm) ± 2.0% (400 - 449 nm) ± 1.5% (450 - 809 nm) ± 2.0% (810 - 899 nm) ± 4.0% (900 - 1009 nm) ± 7.5% (1010 - 1080 nm)	± 18% (210 - 229 nm) ± 8.0% (230 - 254 nm) ± 6.5% (255 - 399 nm) ± 2.5% (400 - 899 nm) ± 4.0% (900 - 1009 nm) ± 7.5% (1010 - 1080 nm)	± 5.0% (800 - 1049 nm) ± 3.5% (1050 - 1559 nm) ± 7.0% (1560 - 1629 nm) ± 10% (1630 - 1650 nm) --- ---
Calibration uncertainty (with OD filters)	± 5.0% (400 - 419 nm) ± 4.0% (420 - 899 nm) ± 5.0% (900 - 1009 nm) ± 7.5% (1010 - 1080 nm)	Same as without attenuator --- --- ---	± 5.0% (900 - 1559 nm) ± 7.0% (1560 - 1629 nm) ± 10% (1630 - 1650 nm) ---
DAMAGE THRESHOLDS			
Maximum average power density	100 W/cm ²	100 W/cm ²	100 W/cm ²
PHYSICAL CHARACTERISTICS			
Effective aperture	10 mm ϕ	10 mm ϕ	5 mm ϕ
Distance to sensor face	13.7 mm	13.7 mm	10.5 mm
Sensor	Silicon	UV-Silicon	Germanium
Dimensions	38.1 ϕ x 27.4D mm	38.1 ϕ x 27.4D mm	38.1 ϕ x 27.4D mm
Weight (head only)	130 g	130 g	130 g
ORDERING INFORMATION			
Available output options	DB15, USB or RS-232	DB15, USB or RS-232	DB15, USB or RS-232
Compatible stand	STAND-D-233 or STAND-D-233-M	STAND-D-233 or STAND-D-233-M	STAND-D-233 or STAND-D-233-M
Product page			

* See curves (p. 62-64) for maximum power at other wavelengths

a. Nominal value. Depends on environmental electromagnetic interference and wavelength.

PRONTO-Si

0.3 nW - 800 mW power probe with touchscreen controls

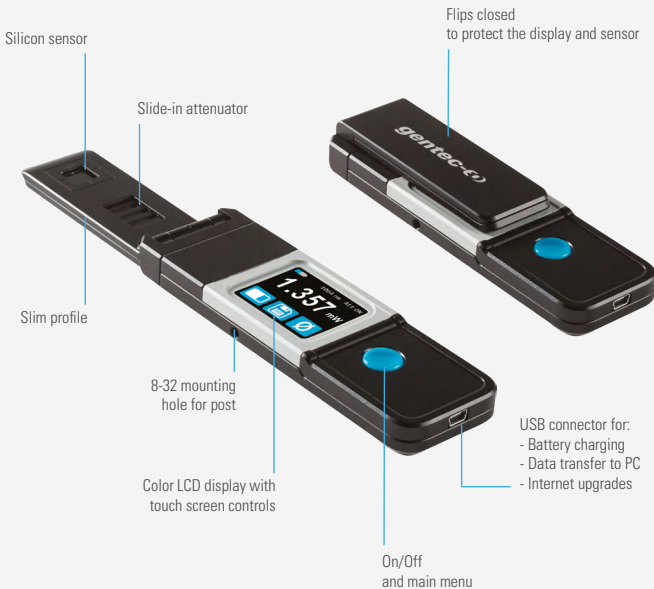

KEY FEATURES

> POCKET-SIZE

This low power laser probe is so compact it fits in your pocket!

> SLIM PROFILE

The sensor part is only 6 mm thick, allowing it to fit into tight spaces

> EASY TO USE

The color LCD touchscreen allows for a friendly user interface. You can make a measurement with just the touch of a button!

> VERY LOW POWER MEASUREMENTS

Thanks to its very low noise level of only 10 pW, the PRONTO-Si measures powers as low as 0.3 nW

> SLIDE-IN ATTENUATOR

Just slide the OD1 integrated filter to the ON position and you can measure up to 800 mW of continuous power at 532 nm (maximum power varies with wavelength)

> DATA LOGGING

Save your data to the internal memory and then transfer them to your PC over the USB connection

> OPTIONAL FIBER OPTICS ADAPTOR

The fiber optics adaptor is held securely in place with a set screw and is compatible with OD attenuators

> SERIAL COMMANDS

Serial commands are available to let you take full control of your PRONTO from your PC.

USER INTERFACE

3 Displays for the measurements

Real-time display



Displays the measured value with large digits so you can see them from a distance

Bargraph display

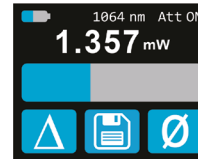

Adds a bargraph below the measured value, for an intuitive understanding of the trend of your laser

Min/Max display



In addition to the real time value, the device displays the lowest and highest values

Save your data and transfer it to your PC



Adjust the wavelength



Set the brightness and orientation

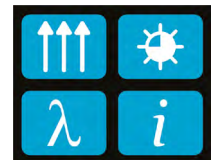

DATA TRANSFER TO PC



ACCESSORIES



Threaded adaptor for PRONTO-Si



Fiber adaptors



PRONTO-SI

MAX AVERAGE POWER* (ATTENUATOR OFF / ATTENUATOR ON)	88 mW / 800 mW
EFFECTIVE APERTURE	10 x 10 mm
INTERFACE	Touchscreen color LCD display

MEASUREMENT CAPABILITY

Calibrated spectral range	
Attenuator OFF	320 - 1100 nm
Attenuator ON	400 - 1100 nm
Power range*	
Attenuator OFF	0.3 nW - 88 mW at 532 nm
Attenuator ON	3 nW - 800 mW at 532 nm
Noise equivalent power	10 pW at 980 nm
Response time	0.2 s
Measurement accuracy	From ± 1.5% to ± 7.5% (wavelength-dependent)
Display resolution	1 pW

DAMAGE THRESHOLDS

Maximum average power density	100 W/cm ²
Maximum average power	800 mW (with attenuator ON)

USER INTERFACE

Displays	Real-time, bar graph and min/max
Measurement controls	Zero offset, wavelength selection and reset data
Data acquisition and transfer	Yes

GENERAL SPECIFICATIONS

Display type	Touchscreen Color LCD
Display size	28.0 x 35.0 mm (128 x 160 pixels)
Data storage	50 000 pts
Battery type	Rechargeable Li-ion
Battery life	17 hours (with brightness set at 25%)
Battery recharge via	USB port

PHYSICAL CHARACTERISTICS

Effective aperture	10 x 10 mm
Sensor	Silicon
Attenuator	Integrated slide-in OD1 attenuator
Mounting hole (for post)	1 x 8-32
Dimensions (Open)	41W x 216.2L x 15.8D mm (Sensor part is only 6.0D mm)
Dimensions (Closed)	41W x 136L x 22.1D mm
Weight	150 g

ORDERING INFORMATION

Compatible stand	STAND-S-233
Product page	

* See curves (page 65) for maximum power at other wavelengths

UM-B

5 nW - 25 mW, radiometer for ultra-low power measurements



KEY FEATURES

- > **VERY LOW NOISE LEVEL**
Noise levels of a photodetector, but with the large bandwidth of a pyroelectric:
 - Down to 5 nW when using the analog power module (APM)
- > **VERY HIGH RESPONSIVITY**
Up to 20 000 V/W when using the analog power module (APM)
- > **VERY LARGE BANDWIDTH**
From DUV to FIR thanks to pyroelectric technology
- > **INCLUDES AN ISOLATING TUBE TO BLOCK UNDESIRABLE NOISE FROM THE ENVIRONMENT.**

OUTPUT OPTIONS

- > **SMART DB15 CONNECTOR**
Contains all the calibration data
Included in UM9B-BL-D0 model only
- > **ANALOG OUTPUT**
When used with APM (D) analog power supply

COMPATIBLE DISPLAYS & PC INTERFACES



MIRO ALTITUDE



MAESTRO



U-LINK



M-LINK



APM (D) analog power supply
(for UM9B-BL-L-D0)

ACCESSORIES



Stand with delrin post



SDC-500 digital
optical chopper



Extra isolation tube





Fiber adaptors & connectors
(FC, ST and SMA)



Pelican carrying case



	UM9B-BL-L-D0	UM9B-BL-D0
MAX AVERAGE POWER	200 μ W	20 mW (MAESTRO), 25 mW (M-LINK)
EFFECTIVE APERTURE	9 mm \varnothing	9 mm \varnothing
COMPATIBLE DISPLAYS & PC INTERFACES	APM (D)	MIRO ALTITUDE, MAESTRO, U-LINK and M-LINK
MEASUREMENT CAPABILITY		
Spectral range	0.1 - 20 μ m	0.1 - 20 μ m
Calibrated spectral range	633 nm ^b	0.248 - 2.1 μ m ^a
Maximum measurable power	200 μ W	20 mW (MAESTRO), 25 mW (M-LINK)
Noise equivalent power (RMS)	5 nW	300 nW
Rise time (0-100%)	\leq 0.2 s	\leq 0.2 s
Calibration uncertainty	\pm 4% at 1064 nm	\pm 4% at 1064 nm
Chopper frequency	5 \pm 1 Hz	10 \pm 1 Hz
DAMAGE THRESHOLDS		
Maximum average power density (1064 nm)	50 mW/cm ²	50 mW/cm ²
PHYSICAL CHARACTERISTICS		
Effective aperture	9 mm \varnothing	9 mm \varnothing
Sensor	Pyroelectric	Pyroelectric
Absorber	BL	BL
Dimensions	38.1 \varnothing X 79D mm	38.1 \varnothing X 79D mm
Weight	91 g	91 g
ORDERING INFORMATION		
Available output options	DB15 only	DB15 only
Compatible stand	STAND-D-233 or STAND-D-233-M	STAND-D-233 or STAND-D-233-M
Product page		

a. Calibrations at 2.1 to 2.5 μ m and 10.6 μ m are available on special request.
 b. Typical wavelength correction factors are provided for 0.19 to 2.1 μ m.

XLP12

12 mm Ø, 0.5 µW - 3 W, low power thermopile



KEY FEATURES

- > **LOW POWER THERMOPILE**
Noise level of a photodetector with the large bandwidth and high power capacity of a thermal device
- > **MINIMAL THERMAL DRIFT**
Only 6 µW/°C (with the IR filter)
- > **HIGH SENSITIVITY**
- > **SPECIAL MODEL FOR ULTRASHORT PULSES**
VP (volume absorber) version is perfect for low power lasers with ultrashort pulses (ps and fs)
- > **IR FILTER (XLPF12 MODEL)**
Removes unwanted IR interference
- > **ISOLATION TUBE**
Eliminates power fluctuations created by air turbulence

OUTPUT OPTIONS

- > **SMART DB15 CONNECTOR**
Contains all the calibration data
- > **integra ALL-IN-ONE-METER**
Connects directly to a PC
Two models available:
 - USB output (-INT)
 - RS-232 output (-IDR)

COMPATIBLE DISPLAYS & PC INTERFACES



MIRO ALTITUDE



MAESTRO



TUNER



UNO



U-LINK and P-LINK



S-LINK and M-LINK

ACCESSORIES



Stand with steel post



Extension cables
(4, 15, 20 or 25 m)



IR filter
(Mounted)



Fiber adaptors & connectors
(FC, ST and SMA)





Pelican carrying case



Extra isolation tube



	XLP12-3S-H2-D0	XLP12-3S-H2-D0	XLP12-3S-VP-D0
MAX AVERAGE POWER (CONTINUOUS / 1 MINUTE)	3 W / 3 W Broadband absorber	3 W / 3 W Broadband absorber, with IR filter	3 W / 3 W Volume absorber
EFFECTIVE APERTURE	12 mm ϕ	12 mm ϕ	12 mm ϕ
COOLING METHOD	Convection	Convection	Convection
MEASUREMENT CAPABILITY			
Spectral range	0.19 - 20 μm	0.28 - 2.1 μm	0.248 - 20 μm
Calibrated spectral range ^a	0.248 - 2.1 μm	0.308 - 2.1 μm	0.248 - 2.1 μm
Noise equivalent power ^b	0.5 μW	0.5 μW	0.5 μW
Thermal drift ^c	12 $\mu\text{W}/^{\circ}\text{C}$	6 $\mu\text{W}/^{\circ}\text{C}$	12 $\mu\text{W}/^{\circ}\text{C}$
Rise time (nominal) ^d	2.5 s	2.5 s	3 s
Calibration uncertainty ^e	$\pm 2.5\%$	$\pm 2.5\%$	$\pm 2.5\%$
Repeatability	$\pm 0.5\%$	$\pm 0.5\%$	$\pm 0.5\%$
Energy mode			
Maximum measurable energy ^f	5 J	5 J	---
Noise equivalent energy ^b	12 μJ	12 μJ	---
Minimum repetition period	16 s	16 s	---
Maximum pulse width	300 ms	300 ms	---
Accuracy with energy calibration option	$\pm 5\%$	$\pm 5\%$	---
DAMAGE THRESHOLDS			
Maximum average power density ^g	1 kW/cm ²	1 kW/cm ²	30 W/cm ² at 1064 nm 8 W/cm ² at 532 nm 4 W/cm ² at 355 nm
Maximum energy density			
1064 nm, 360 μs , 5 Hz	5 J/cm ²	5 J/cm ²	---
1064 nm, 7 ns, 10 Hz	1 J/cm ²	1 J/cm ²	4 J/cm ²
532 nm, 7 ns, 10 Hz	0.6 J/cm ²	0.6 J/cm ²	3 J/cm ²
355 nm, 7 ns, 10 Hz	---	---	1 J/cm ²
266 nm, 7 ns, 10 Hz	0.3 J/cm ²	0.3 J/cm ²	---
PHYSICAL CHARACTERISTICS			
Effective aperture	12 mm ϕ	12 mm ϕ	12 mm ϕ
Absorber (high damage threshold)	H2	H2	VP (Volume absorber)
Dimensions	73H x 73W x 20D mm (72D mm with tube)	73H x 73W x 20D mm (80D mm with tube)	73H x 73W x 20D mm (72D mm with tube)
Weight (head only)	0.31 kg	0.32 kg	0.32 kg
ORDERING INFORMATION			
Available output options	DB15, USB, RS-232 or Bluetooth	DB15, USB, RS-232 or Bluetooth	DB15, USB, RS-232 or Bluetooth
Compatible stand	STAND-S-233	STAND-S-233	STAND-S-233
Product page			

a. Calibrations at 2.1 to 2.5 μm and 10.6 μm are available on special request.
 b. Nominal value, actual value depends on electrical noise in the measurement system.
 c. With Gentec-EO MAESTRO.
 d. With anticipation.
 e. Including linearity with power.
 f. For 360 μs pulses. Higher pulse energy possible for long pulses (ms), less for short pulses (ns).
 g. At 1064 nm, 1 W CW.

UP10-H

10 mm Ø, 0.1 mW - 2 W, fast & low power thermopile



KEY FEATURES

- > **LOW POWER THERMOPILE**
Noise level of a photodetector with the large bandwidth and high power capacity of a thermal device
- > **HIGH PERFORMANCE**
Fast rise time (1.4 s)
High damage threshold (36 kW/cm²)
- > **COMPACT DESIGN**
Only 13 mm thick (UP10P model)
- > **ENERGY MODE**
Measure single shot energy up to 3 J

OUTPUT OPTIONS

- > **SMART DB15 CONNECTOR**
Contains all the calibration data
- > **integra ALL-IN-ONE-METER**
Connects directly to a PC
Two models available:
 - USB output (-INT)
 - RS-232 output (-IDR)

COMPATIBLE DISPLAYS & PC INTERFACES



MIRO ALTITUDE



MAESTRO



TUNER



UNO



U-LINK and P-LINK



S-LINK and M-LINK

ACCESSORIES



Stand with steel post



Extension Cables
(4, 15, 20 or 25 m)



IR Filter
(Mounted)



Isolation tube



Fiber adaptors & connectors
(FC, ST and SMA)



Pelican carrying case



	UPI0P-2S-H5-L-D0	UPI0K-2S-H5-L-D0
MAX AVERAGE POWER	2 W	2 W
EFFECTIVE APERTURE	10 mm Ø	10 mm Ø
COOLING METHOD	Convection	Convection
MEASUREMENT CAPABILITY		
Spectral range	0.19 - 20 µm	0.19 - 20 µm
Calibrated spectral range ^a	0.248 - 2.1 µm	0.248 - 2.1 µm
Noise equivalent power ^b	100 µW without anticipation 30 µW with anticipation and 2 s moving average	100 µW without anticipation 30 µW with anticipation and 2 s moving average
Rise time (nominal) ^c	1.4 s	1.1 s
Calibration uncertainty ^d	± 2.5%	± 2.5%
Repeatability	±0.5%	±0.5%
Energy mode		
Maximum measurable energy ^e	3 J	3 J
Noise equivalent energy ^b	5 mJ	5 mJ
Minimum repetition period	2 s	2 s
Maximum pulse width	63 ms	63 ms
Accuracy with energy calibration option	± 5%	± 5%
DAMAGE THRESHOLDS		
Maximum average power density ^f	36 kW/cm ²	36 kW/cm ²
Maximum energy density		
1064 nm, 360 µs, 5 Hz	5 J/cm ²	5 J/cm ²
1064 nm, 7 ns, 10 Hz	1 J/cm ²	1 J/cm ²
532 nm, 7 ns, 10 Hz	0.6 J/cm ²	0.6 J/cm ²
266 nm, 7 ns, 10 Hz	0.3 J/cm ²	0.3 J/cm ²
PHYSICAL CHARACTERISTICS		
Effective aperture	10 mm Ø	10 mm Ø
Absorber (high damage threshold)	H5	H5
Dimensions	46H x 46W x 13D mm	50H x 50W x 21.5D mm
Weight (head only)	0.13 kg	0.19 kg
ORDERING INFORMATION		
Available output options	DB15, USB or RS-232	DB15, USB, RS-232
Compatible stand	STAND-S-233	STAND-S-233
Product page		

a. Calibrations at 2.1 to 2.5 µm and 10.6 µm are available on special request.
b. Nominal value, actual value depends on electrical noise in the measurement system.
c. With anticipation.
d. Including linearity with power.
e. For 360 µs pulses. Higher pulse energy possible for long pulses (ms), less for short pulses (ns).
f. At 1064 nm, 10 W CW.

UP12-H

12 mm Ø, 1 mW - 110 W



KEY FEATURES

- > **MODULAR CONCEPT**
Increase the power capability of your detector: 3 different cooling modules
- > **HIGH PERFORMANCE**
Fast rise time (0.3 s)
High damage threshold (36 kW/cm²)
- > **COMPACT DESIGN**
Only 14 mm thick (10S model)
- > **ENERGY MODE**
Measure single shot energy up to 5 J

OUTPUT OPTIONS

- > **SMART DB15 CONNECTOR**
Contains all the calibration data
- > **integra ALL-IN-ONE-METER**
Connects directly to a PC
Two models available:
 - USB output (-INT)
 - RS-232 output (-IDR)

COMPATIBLE DISPLAYS & PC INTERFACES



MIRO ALTITUDE



MAESTRO



TUNER



UNO



U-LINK and P-LINK



S-LINK and M-LINK

ACCESSORIES



Stand with steel post



Extension cables
(4, 15, 20 or 25 m)





Replacement cover
for fiber adaptors



Pelican carrying Case



	UP12E-10S-H5-D0	UP12E-20H-H5-D0	UP12E-70W-H5-D0
MAX AVERAGE POWER (CONTINUOUS / 1 MINUTE)	10 W / 20 W	20 W / 40 W	70 W ^f / 110 W ^f
EFFECTIVE APERTURE	12 mm Ø	12 mm Ø	12 mm Ø
COOLING METHOD	Convection	Heatsink	Water-cooled
MEASUREMENT CAPABILITY			
Spectral range	0.19 - 20 µm	0.19 - 20 µm	0.19 - 20 µm
Calibrated spectral range^a	0.248 - 2.1 µm	0.248 - 2.1 µm	0.248 - 2.1 µm
Noise equivalent power^b	1 mW	1 mW	1 mW
Rise time (nominal)^c	0.3 s	0.3 s	0.3 s
Calibration uncertainty^d	± 2.5%	± 2.5%	± 2.5%
Repeatability	±0.5%	±0.5%	±0.5%
Energy mode			
Maximum measurable energy^e	5 J	5 J	5 J
Noise equivalent energy^b	0.02 J	0.02 J	0.02 J
Minimum repetition period	1.5 s	1.5 s	1.5 s
Maximum pulse width	50 ms	50 ms	50 ms
Accuracy with energy calibration option	± 5%	± 5%	± 5%
DAMAGE THRESHOLDS			
Maximum average power density^g	36 kW/cm ²	36 kW/cm ²	36 kW/cm ²
Maximum energy density			
1064 nm, 360 µs, 5 Hz	5 J/cm ²	5 J/cm ²	5 J/cm ²
1064 nm, 7 ns, 10 Hz	1 J/cm ²	1 J/cm ²	1 J/cm ²
532 nm, 7 ns, 10 Hz	0.6 J/cm ²	0.6 J/cm ²	0.6 J/cm ²
266 nm, 7 ns, 10 Hz	0.3 J/cm ²	0.3 J/cm ²	0.3 J/cm ²
PHYSICAL CHARACTERISTICS			
Effective aperture	12 mm Ø	12 mm Ø	12 mm Ø
Absorber (high damage threshold)	H5	H5	H5
Dimensions	38H x 38W x 14D mm	38H x 38W x 45D mm	38H x 38W x 32D mm
Weight (head only)	0.13 kg	0.15 kg	0.19 kg
ORDERING INFORMATION			
Available output options	DB15, USB or RS-232	DB15, USB or RS-232	DB15, USB or RS-232
Compatible stand	STAND-S-233	STAND-S-233	STAND-S-233
Product page			

- a. Calibrations at 2.1 to 2.5 µm and 10.6 µm are available on special request.
- b. Nominal value, actual value depends on electrical noise in the measurement system.
- c. With anticipation.
- d. Including linearity with power.
- e. For 360 µs pulses. Higher pulse energy possible for long pulses (ms), less for short pulses (ns).
- f. Minimum cooling flow 0.5 liters/min, water temperature ≤ 22°C, 1/8 NPT compression fittings for 1/4 inch semi-rigid tube. Contact Gentec-EO for clean deionized water cooling module option.
- g. At 1064 nm, 10 W CW.

UP17-H/W

17 mm Ø, 1 mW - 7 W, ultra thin casing



KEY FEATURES

- > **ULTRA THIN CASING**
Only 10.7 mm thick!
- > **CHOICE BETWEEN 2 ABSORBERS**
 - H5: 36 kW/cm²
 - W5: unequalled 100 kW/cm²
- > **HIGH POWER TO SIZE RATIO**
6 W continuous reading
- > **ENERGY MODE**
Measure single shot energy up to 200 J
(with the W5 version)

OUTPUT OPTIONS

- > **SMART DB15 CONNECTOR**
Contains all the calibration data
- > **integra ALL-IN-ONE-METER**
Connects directly to a PC
Two models available:
 - USB output (-INT)
 - RS-232 output (-IDR)

COMPATIBLE DISPLAYS & PC INTERFACES



MIRO ALTITUDE



MAESTRO



TUNER



UNO



U-LINK and P-LINK



S-LINK and M-LINK

ACCESSORIES



Stand with steel post





Extension cables
(4, 15, 20 or 25 m)



Pelican carrying case



	UPI7P-6S-H5-D0	UPI7P-6S-W5-D0
MAX AVERAGE POWER (CONTINUOUS / 1 MINUTE)	6 W / 7 W	6 W / 7 W
EFFECTIVE APERTURE	17 mm \emptyset	17 mm \emptyset
COOLING METHOD	Convection	Convection
MEASUREMENT CAPABILITY		
Spectral range	0.19 - 20 μm	0.19 - 10.0 μm
Calibrated spectral range	0.248 - 2.1 μm ^a	0.248 - 2.1 μm ^b
Noise equivalent power^c	1 mW	1 mW
Rise time (nominal)^d	0.8 s	1.4 s
Calibration uncertainty^e	$\pm 2.5\%$	$\pm 2.5\%$
Repeatability	$\pm 0.5\%$	$\pm 0.5\%$
Energy mode		
Maximum measurable energy ^f	15 J	200 J
Noise equivalent energy ^c	0.02 J	0.02 J
Minimum repetition period	4 s	5 s
Maximum pulse width	88 ms	133 ms
Accuracy with energy calibration option	$\pm 5\%$	$\pm 5\%$
DAMAGE THRESHOLDS		
Maximum average power density^g	36 kW/cm ²	100 kW/cm ²
Maximum energy density		
1064 nm, 360 μs , 5 Hz	5 J/cm ²	100 J/cm ²
1064 nm, 7 ns, 10 Hz	1 J/cm ²	1.1 J/cm ²
532 nm, 7 ns, 10 Hz	0.6 J/cm ²	1.1 J/cm ²
266 nm, 7 ns, 10 Hz	0.3 J/cm ²	0.7 J/cm ²
PHYSICAL CHARACTERISTICS		
Effective aperture	17 mm \emptyset	17 mm \emptyset
Absorber (high damage threshold)	H5	W5
Dimensions	46H x 46W x 10.7D mm	46H x 46W x 10.7D mm
Weight (head only)	0.1 kg	0.1 kg
ORDERING INFORMATION		
Available output options	DB15, USB or RS-232	DB15, USB or RS-232
Compatible stand	STAND-S-233	STAND-S-233
Product page		

a. Calibrations at 2.1 to 2.5 μm and 10.6 μm are available on special request.
 b. Calibration at 2.1 to 2.5 μm is available on special request.
 c. Nominal value, actual value depends on electrical noise in the measurement system.
 d. With anticipation.
 e. Including linearity with power.
 f. For 360 μs pulses. Higher pulse energy possible for long pulses (ms), less for short pulses (ns).
 g. At 1064 nm, 10 W CW.

UP19-H

19 mm Ø, 1 mW - 200 W



KEY FEATURES

- > **MODULAR CONCEPT**
Increase the power capability of your detector: 5 different cooling modules
- > **HIGH PERFORMANCE**
Fast Rise Time (0.6 s)
High damage threshold (45 kW/cm²)
- > **COMPACT DESIGN**
Only 20.6 mm thick (15S model)
- > **ENERGY MODE**
Measure single shot energy up to 25 J

OUTPUT OPTIONS

- > **SMART DB15 CONNECTOR**
Contains all the calibration data
- > **integra ALL-IN-ONE-METER**
Connects directly to a PC
Two models available:
 - USB output (-INT)
 - RS-232 output (-IDR)
- > **BLU WIRELESS METER** 
Connects via Bluetooth® to a smartphone, tablet or PC

COMPATIBLE DISPLAYS & PC INTERFACES



MIRO ALTITUDE



MAESTRO



TUNER



UNO



U-LINK and P-LINK



S-LINK and M-LINK

ACCESSORIES



Stand with steel post



Extension cables
(4, 15, 20 or 25 m)



Isolation tube



Fiber adaptors and connectors
(FC, SC or SMA)







12V power supply



Pelican carrying case



	UP19K-15S-H5-D0	UP19K-30H-H5-D0	UP19K-50L-H5-D0	UP19K-110F-H9-D0	UP19K-200W-H9-D0
MAX AVERAGE POWER (CONTINUOUS / 1 MINUTE)	15 W / 30 W	30 W / 60 W	50 W / 90 W	110 W / 150 W	200 W ^f / 200 W ^f
EFFECTIVE APERTURE	19 mm ϕ	19 mm ϕ	19 mm ϕ	19 mm ϕ	19 mm ϕ
COOLING METHOD	Convection	Heatsink	Large heatsink	Fan-cooled	Water-cooled
MEASUREMENT CAPABILITY					
Spectral range	0.19 - 20 μm	0.19 - 20 μm	0.19 - 20 μm	0.19 - 20 μm	0.19 - 20 μm
Calibrated spectral range^a	0.248 - 2.1 μm	0.248 - 2.1 μm	0.248 - 2.1 μm	0.248 - 2.1 μm	0.248 - 2.1 μm
Noise equivalent power^b	1 mW	1 mW	1 mW	3 mW	3 mW
Rise time (nominal)^c	0.6 s	0.6 s	0.6 s	1.5 s	1.5 s
Calibration uncertainty^d	$\pm 2.5\%$	$\pm 2.5\%$	$\pm 2.5\%$	$\pm 2.5\%$	$\pm 2.5\%$
Repeatability	$\pm 0.5\%$	$\pm 0.5\%$	$\pm 0.5\%$	$\pm 0.5\%$	$\pm 0.5\%$
Energy mode					
Maximum measurable energy^e	15 J	15 J	15 J	25 J	25 J
Noise equivalent energy^b	0.02 J	0.02 J	0.02 J	0.06 J	0.06 J
Minimum repetition period	4 s	4 s	4 s	4 s	4 s
Maximum pulse width	88 ms	88 ms	88 ms	88 ms	88 ms
Accuracy with energy calibration option	$\pm 5\%$	$\pm 5\%$	$\pm 5\%$	$\pm 5\%$	$\pm 5\%$
DAMAGE THRESHOLDS					
Maximum average power density^a	36 kW/cm ²	36 kW/cm ²	36 kW/cm ²	45 kW/cm ²	45 kW/cm ²
Maximum energy density					
1064 nm, 360 μs, 5 Hz	5 J/cm ²	5 J/cm ²	5 J/cm ²	5 J/cm ²	5 J/cm ²
1064 nm, 7 ns, 10 Hz	1 J/cm ²	1 J/cm ²	1 J/cm ²	1 J/cm ²	1 J/cm ²
532 nm, 7 ns, 10 Hz	0.6 J/cm ²	0.6 J/cm ²	0.6 J/cm ²	0.6 J/cm ²	0.6 J/cm ²
266 nm, 7 ns, 10 Hz	0.3 J/cm ²	0.3 J/cm ²	0.3 J/cm ²	0.3 J/cm ²	0.3 J/cm ²
PHYSICAL CHARACTERISTICS					
Effective aperture	19 mm ϕ	19 mm ϕ	19 mm ϕ	19 mm ϕ	19 mm ϕ
Absorber (high damage threshold)	H5	H5	H5	H9	H9
Dimensions	50H x 50W x 20.6D mm	50H x 50W x 56.3D mm	76.2H x 76.2W x 73.6D mm	50H x 50W x 63D mm	50H x 50W x 33D mm
Weight (head only)	0.16 kg	0.21 kg	0.48 kg	0.25 kg	0.24 kg
ORDERING INFORMATION					
Available output options	DB15, USB, RS-232 or Bluetooth	DB15, USB, RS-232 or Bluetooth	DB15, USB or RS-232	DB15, USB, RS-232 or Bluetooth	DB15, USB, RS-232 or Bluetooth
Compatible stand	STAND-S-233	STAND-S-233	STAND-S-233	STAND-S-233	STAND-S-233
Product page					

a. Calibrations at 2.1 to 2.5 μm and 10.6 μm are available on special request.
 b. Nominal value, actual value depends on electrical noise in the measurement system.
 c. With anticipation.
 d. Including linearity with power.
 e. For 360 μs pulses. Higher pulse energy possible for long pulses (ms), less for short pulses (ns).
 f. Minimum cooling flow 0.5 liters/min, water temperature $\leq 22^\circ\text{C}$, 1/8 NPT compression fittings for 1/4 inch semi-rigid tube.
 Contact Gentec-EO for clean deionized water cooling module option.
 g. At 1064 nm, 10 W CW.

PRONTO

0.5 W - 250 W power probes with touchscreen controls



KEY FEATURES

- **POCKET-SIZE**
This mid to high power laser probe is so compact it fits in your pocket!
- **EASY TO USE**
The color LCD touchscreen allows for a friendly user interface. You can make a measurement with just the touch of a button!
- **DATA LOGGING**
Save your data to the internal memory and then transfer them to your PC over the USB connection.
- **FROM LOW TO HIGH POWERS**
Thanks to a low noise level and high damage threshold, the PRONTO can measure powers from 0.5 W to 250 W.
- **YAG AND CO₂ CALIBRATIONS**
The PRONTO-250 comes fully calibrated: every wavelength between 248 nm and 2.5 μm (YAG), and a real calibration at 10.6 μm (CO₂).

The PRONTO-250-PLUS has an additional calibration for Single-Shot Energy measurements.

- **HANDS-FREE OPERATION**
Place it on a flat surface or use one of the 2 threaded holes for safe use with optical stands.
- **SERIAL COMMANDS**
Serial commands are available to let you take full control of your PRONTO from your PC.

USER INTERFACES (SSP MODE)

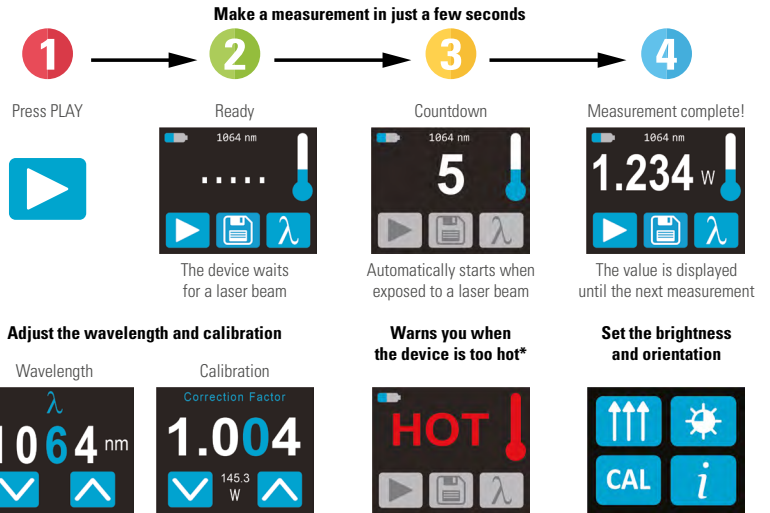

* Device may get hot, it is not recommended for handheld use when making a measurement

3 MODELS FOR ALL YOUR MEASUREMENT NEEDS

- **PRONTO-250**
PRONTO-250 is very easy to use and will give you accurate one shot measurements, thanks to its unique measurement mode:
 - Single shot power (SSP): up to 250 W
- **PRONTO-250-PLUS**
PRONTO-250-PLUS comes with 3 measurement modes and can be used in a variety of applications:
 - Single shot power (SSP): up to 250 W
 - Continuous power (CWP): up to 8 W
 - Single shot energy (SSE): up to 25 J
- **PRONTO-50-W5**
This model has our proprietary absorber with extremely high damage thresholds to handle tightly focused beams without damaging the absorber.
 - Single shot power (SSP): up to 50 W

CONNECTIVITY





HANDS-FREE



DATA TRANSFER TO PC



	PRONTO-250	PRONTO-250-PLUS	PRONTO-50-W5		
		SSP Mode Measures in 5 s	CWP Mode Measures power continuously	SSE Mode Measures in less than 0.5 s	
MAX AVERAGE POWER/ENERGY	250 W	250 W	8 W	25 J (up to 150 J for pulses >1 ms)	50 W
EFFECTIVE APERTURE	19 mm Ø	19 mm Ø			19 mm Ø
INTERFACE	Touchscreen color LCD display	Touchscreen color LCD display			Touchscreen color LCD display
MEASUREMENT CAPABILITY					
Spectral range	0.19 - 20 µm	0.19 - 20 µm			0.19 - 10 µm
Calibrated spectral range	0.248 - 2.5 µm and 10.6 µm	0.248 - 2.5 µm and 10.6 µm			0.248 - 2.5 µm
Noise equivalent power/energy	10 mW	10 mW	10 mW	60 mJ	4 mW
Minimum measurable power/energy ^{0.5 W}		0.5 W	0.2 W	N/A	0.5 W
Exposure time	5 s	5 s	1.5 s response time	0.26 s	5 s
Measurement accuracy	± 3%	± 3%	± 2.5%	± 5%	± 3%
Min repetition period (Max pulse width)	N/A	N/A	N/A	4 s (88 ms)	N/A
Display resolution	1 mW	1 mW	1 mW	10 mJ	1 mW
DAMAGE THRESHOLDS					
Maximum average power density ^a	45 kW/cm ² (at 1064 nm, 10 W, CW) 14 kW/cm ² (at 10.6 µm, 10 W, CW)	45 kW/cm ² (at 1064 nm, 10 W, CW) 14 kW/cm ² (at 10.6 µm, 10 W, CW)			100 kW/cm ² (at 1064 nm, 10 W, CW)
Maximum exposure time ^b	6 s	6 s	N/A	N/A	6 s
Maximum device temperature ^b	65°C	65°C	40°C	40°C	65°C
USER INTERFACE					
Measurement controls	Wavelength selection and user calibration	Wavelength selection and user calibration			Wavelength selection and user calibration
Measurement modes	Single Shot Power (SSP)	Single Shot Power (SSP), Continuous Power (CWP) and Single Shot Energy (SSE)			Single Shot Power (SSP)
Data acquisition and transfer	Yes	Yes			Yes
GENERAL SPECIFICATIONS					
Display type	Touchscreen color LCD	Touchscreen color LCD			Touchscreen color LCD
Display size	28.0 x 35.0 mm (128 x 160 pixels)	28.0 x 35.0 mm (128 x 160 pixels)			28.0 x 35.0 mm (128 x 160 pixels)
Data storage	50 000 pts	50 000 pts			50 000 pts
Battery type	Rechargeable Li-ion	Rechargeable Li-ion			Rechargeable Li-ion
Battery life	17 hours or 4 200 measurements (with brightness set at 25%)	17 hours or 4 200 measurements (with brightness set at 25%)			17 hours or 4 200 measurements (with brightness set at 25%)
Battery recharge via	USB port	USB port			USB port
PHYSICAL CHARACTERISTICS					
Effective aperture	19 mm Ø	19 mm Ø			19 mm Ø
Absorber	H9	H9			W5
Mounting holes (for post)	2 x 8-32	2 x 8-32			2 x 8-32
Dimensions	59W x 181.4L x 17D	59W x 181.4L x 17D			59W x 181.4L x 17D
Weight	210 g	210 g			210 g
ORDERING INFORMATION					
Compatible stand	STAND-S-233	STAND-S-233			STAND-S-233
Product page					

a. To get all the damage thresholds, see User Manual.
b. At maximum power.

UP25-H

25 mm Ø, 3 mW - 350 W



KEY FEATURES

- > **MODULAR CONCEPT**
Increase the power capability of your detector:
4 different cooling modules
- > **HIGH PERFORMANCE**
Fast rise time (1.3 s)
High damage threshold (45 kW/cm²)
- > **ENERGY MODE**
Measure single shot energy up to 40 J

OUTPUT OPTIONS

- > **SMART DB15 CONNECTOR**
Contains all the calibration data
- > **integra ALL-IN-ONE-METER**
Connects directly to a PC
Two models available:
 - USB output (-INT)
 - RS-232 output (-IDR)
- > **OPTION SANS-FIL BLU** 
Se connecte via Bluetooth® à un smartphone, une tablette ou un PC

COMPATIBLE DISPLAYS & PC INTERFACES



MIRO ALTITUDE



MAESTRO



TUNER



UNO



U-LINK and P-LINK



S-LINK and M-LINK

ACCESSORIES



Stand with steel post



Extension cables
(4, 15, 20 or 25 m)



Fiber adaptors and connectors
(FC, SC or SMA)



12V power supply







Pelican carrying case

UP25-H

Specifications



	UP25N-40S-H9-D0	UP25N-100H-H9-D0	UP25N-250F-H12-D0	UP25M-350W-H12-D0
MAX AVERAGE POWER (CONTINUOUS / 1 MINUTE)	40 W / 80 W	100 W / 200 W	250 W / 300 W	350 W ^f / 350 W ^f
EFFECTIVE APERTURE	25 mm Ø	25 mm Ø	25 mm Ø	25 mm Ø
COOLING METHOD	Convection	Heatsink	Fan-cooled	Water-cooled
MEASUREMENT CAPABILITY				
Spectral range	0.19 - 20 µm	0.19 - 20 µm	0.19 - 20 µm	0.19 - 20 µm
Calibrated spectral range^a	0.248 - 2.1 µm	0.248 - 2.1 µm	0.248 - 2.1 µm	0.248 - 2.1 µm
Noise equivalent power^b	3 mW	3 mW	10 mW	10 mW
Rise time (nominal)^c	1.3 s	1.3 s	1.3 s	1.3 s
Calibration uncertainty^d	± 2.5%	± 2.5%	± 2.5%	± 2.5%
Repeatability	±0.5%	±0.5%	±0.5%	±0.5%
Energy mode				
Maximum measurable energy ^e	40 J	40 J	40 J	40 J
Noise equivalent energy ^b	0.2 J	0.2 J	0.2 J	0.2 J
Minimum repetition period	4.6 s	4.6 s	11.5 s	11.5 s
Maximum pulse width	123 ms	123 ms	390 ms	390 ms
Accuracy with energy calibration option	± 5%	± 5%	± 5%	± 5%
DAMAGE THRESHOLDS				
Maximum average power density				
1064 nm, 10 W, CW	45 kW/cm ²	45 kW/cm ²	45 kW/cm ²	45 kW/cm ²
10.6 µm, 10 W, CW	14 kW/cm ²	14 kW/cm ²	14 kW/cm ²	14 kW/cm ²
Maximum energy density				
1064 nm, 360 µs, 5 Hz	9 J/cm ²	9 J/cm ²	9 J/cm ²	9 J/cm ²
1064 nm, 7 ns, 10 Hz	1 J/cm ²	1 J/cm ²	1 J/cm ²	1 J/cm ²
532 nm, 7 ns, 10 Hz	0.6 J/cm ²	0.6 J/cm ²	0.6 J/cm ²	0.6 J/cm ²
266 nm, 7 ns, 10 Hz	0.3 J/cm ²	0.3 J/cm ²	0.3 J/cm ²	0.3 J/cm ²
PHYSICAL CHARACTERISTICS				
Effective aperture	25 mm Ø	25 mm Ø	25 mm Ø	25 mm Ø
Absorber (high damage threshold)	H9	H9	H12	H12
Dimensions	89H x 89W x 32D mm	89H x 89W x 106D mm	92H x 92W x 117D mm	89H x 89W x 40D mm
Weight (head only)	0.68 kg	0.99 kg	1.44 kg	0.87 kg
ORDERING INFORMATION				
Available output options	DB15, USB, RS-232 or Bluetooth	DB15, USB, RS-232 or Bluetooth	DB15, USB, RS-232 or Bluetooth	DB15, USB, RS-232 or Bluetooth
Compatible stand	STAND-S-443	STAND-S-443	STAND-S-443	STAND-S-443
Product page				

a. Calibrations at 2.1 to 2.5 µm and 10.6 µm are available on special request.
b. Nominal value, actual value depends on electrical noise in the measurement system.
c. With anticipation.
d. Including linearity with power.
e. For 360 µs pulses. Higher pulse energy possible for long pulses (ms), less for short pulses (ns).
f. Minimum cooling flow 1.5 liters/min, water temperature ≤ 22°C, 1/8 NPT compression fittings for 1/4 inch semi-rigid tube. Contact Gentec-EO for clean deionized water cooling module option.

UP55-H

55 mm Ø, 5 mW - 500 W



KEY FEATURES

- > **MODULAR CONCEPT**
Increase the power capability of your detector:
4 different cooling modules
- > **HIGH PERFORMANCE**
Fast rise time (2 s)
High damage threshold (45 kW/cm²)
- > **COMPACT DESIGN**
Only 32 mm thick (40S model)
- > **ENERGY MODE**
Measure single shot energy up to 200 J

OUTPUT OPTIONS

- > **SMART DB15 CONNECTOR**
Contains all the calibration data
- > **integra ALL-IN-ONE-METER**
Connects directly to a PC
Two models available:
 - USB output (-INT)
 - RS-232 output (-IDR)
- > **BLU WIRELESS METER** 
Connects via Bluetooth® to a smartphone, tablet or PC

COMPATIBLE DISPLAYS & PC INTERFACES



MIRO ALTITUDE



MAESTRO



TUNER



UNO



U-LINK and P-LINK



S-LINK and M-LINK

ACCESSORIES



Stand with steel post



Extension cables
(4, 15, 20 or 25 m)



Fiber adaptors and connectors
(FC, SC or SMA)



3-Port fiber cylinder with
adaptors and plug



12V power supply



Pelican carrying case

UP55-H

Specifications



*Also traceable to NRC-CNRC

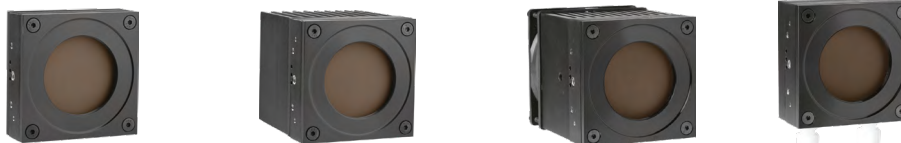

	UP55N-40S-H9-D0	UP55N-100H-H9-D0	UP55N-300F-H12-D0	UP55M-500W-H12-D0
MAX AVERAGE POWER (CONTINUOUS / 1 MINUTE)	40 W / 80 W	100 W / 200 W	300 W / 300 W	500 W ^f / 500 W ^f
EFFECTIVE APERTURE	55 mm ϕ	55 mm ϕ	55 mm ϕ	55 mm ϕ
COOLING METHOD	Convection	Heatsink	Fan-cooled	Water-cooled
MEASUREMENT CAPABILITY				
Spectral range	0.19 - 20 μm	0.19 - 20 μm	0.19 - 20 μm	0.19 - 20 μm
Calibrated spectral range^a	0.248 - 2.1 μm	0.248 - 2.1 μm	0.248 - 2.1 μm	0.248 - 2.1 μm
Noise equivalent power^b	5 mW	5 mW	15 mW	15 mW
Rise time (nominal)^c	2 s	2 s	2 s	2 s
Calibration uncertainty^d	$\pm 2.5\%$	$\pm 2.5\%$	$\pm 2.5\%$	$\pm 2.5\%$
Repeatability	$\pm 0.5\%$	$\pm 0.5\%$	$\pm 0.5\%$	$\pm 0.5\%$
Energy mode				
Maximum measurable energy ^e	200 J	200 J	200 J	200 J
Noise equivalent energy ^b	0.25 J	0.25 J	0.25 J	0.25 J
Minimum repetition period	11.1 s	11.1 s	12 s	12 s
Maximum pulse width	433 ms	433 ms	430 ms	430 ms
Accuracy with energy calibration option	$\pm 5\%$	$\pm 5\%$	$\pm 5\%$	$\pm 5\%$
DAMAGE THRESHOLDS				
Maximum average power density				
1064 nm, 10 W, CW	45 kW/cm ²	45 kW/cm ²	45 kW/cm ²	45 kW/cm ²
10.6 μm , 10 W, CW	14 kW/cm ²	14 kW/cm ²	14 kW/cm ²	14 kW/cm ²
Maximum energy density				
1064 nm, 360 μs , 5 Hz	9 J/cm ²	9 J/cm ²	9 J/cm ²	9 J/cm ²
1064 nm, 7 ns, 10 Hz	1 J/cm ²	1 J/cm ²	1 J/cm ²	1 J/cm ²
532 nm, 7 ns, 10 Hz	0.6 J/cm ²	0.6 J/cm ²	0.6 J/cm ²	0.6 J/cm ²
266 nm, 7 ns, 10 Hz	0.3 J/cm ²	0.3 J/cm ²	0.3 J/cm ²	0.3 J/cm ²
PHYSICAL CHARACTERISTICS				
Effective aperture	55 mm ϕ	55 mm ϕ	55 mm ϕ	55 mm ϕ
Absorber (high damage threshold)	H9	H9	H12	H12
Dimensions	89H x 89W x 32D mm	89H x 89W x 106D mm	92H x 92W x 117D mm	89H x 89W x 40D mm
Weight (head only)	0.62 kg	0.93 kg	1.41 kg	0.81 kg
ORDERING INFORMATION				
Available output options	DB15, USB, RS-232 or Bluetooth	DB15, USB, RS-232 or Bluetooth	DB15, USB, RS-232 or Bluetooth	DB15, USB, RS-232 or Bluetooth
Compatible stand	STAND-S-443	STAND-S-443	STAND-S-443	STAND-S-443
Product page				

- a. Calibrations at 2.1 to 2.5 μm and 10.6 μm are available on special request.
- b. Nominal value, actual value depends on electrical noise in the measurement system.
- c. With anticipation.
- d. Including linearity with power.
- e. For 360 μs pulses. Higher pulse energy possible for long pulses (ms), less for short pulses (ns).
- f. Minimum cooling flow 1.5 liters/min, water temperature $\leq 22^\circ\text{C}$, 1/8 NPT compression fittings for 1/4 inch semi-rigid tube. Contact Gentec-EO for clean deionized water cooling module option.

Specifications are subject to change without notice

UP55-HD

55 mm Ø, 45 mW - 2500 W



KEY FEATURES

- > **HIGH DENSITY ABSORBER**
The HD absorber is the strongest on the market for use at high powers, presenting both high average power handling and high power density capabilities
- > **UP55G-600F-HD - NO NEED FOR WATER COOLING**
Unique on the market, measure 600 W of continuous power WITHOUT THE NEED FOR WATER COOLING. Just plug the fan and you are ready to go!
- > **UP55M-700W-HD - FAST AND COMPACT**
A very compact detector that measures up to 700 W of continuous power.
- > **UP55C-2.5KW-HD - PERFORMANCE AND SPEED AT A LOW PRICE**
Measures both very low and very high powers (up to 2500W) with a fast response time. A compact and versatile detector that is more affordable than any other high power solution on the market.

OUTPUT OPTIONS

- > **SMART DB15 CONNECTOR**
Contains all the calibration data
- > **integra ALL-IN-ONE-METER**
Connects directly to a PC
Two models available:
 - USB output (-INT)
 - RS-232 output (-IDR)
- > **BLU WIRELESS METER** 
Connects via Bluetooth® to a smartphone, tablet or PC

COMPATIBLE DISPLAYS & PC INTERFACES



MIRO ALTITUDE



MAESTRO



TUNER



UNO



U-LINK and P-LINK



S-LINK and M-LINK

ACCESSORIES



Stand with steel post



Extension cables
(4, 15, 20 or 25 m)



Fiber adaptors and connectors
(FC, SC or SMA)



3-Port fiber cylinder with
adaptors and plug



12V power supply



Pelican carrying case

UP55-HD

Specifications



*Also traceable to NRC-CNRC



	UP55C-600F-HD-D0	UP55M-700W-HD-D0	UP55C-2.5KW-HD-D0
MAX AVERAGE POWER (CONTINUOUS / 1 MINUTE)	600 W / 600 W	700 W ^f / 700 W ^f	2500 W ^f / 2500 W ^f
EFFECTIVE APERTURE	55 mm Ø	55 mm Ø	55 mm Ø
COOLING METHOD	Fan-cooled	Water-cooled	Water-cooled
MEASUREMENT CAPABILITY			
Spectral range	0.19 - 20 µm	0.19 - 20 µm	0.19 - 20 µm
Calibrated spectral range^a	0.248 - 2.1 µm	0.248 - 2.1 µm	0.248 - 2.1 µm
Noise equivalent power^b	45 mW	45 mW	200 mW
Rise time (nominal)^c	2,8 s	2.8 s	3.5 s
Calibration uncertainty^d	± 2.5%	± 2.5%	± 2.5%
Repeatability	±0.5%	±0.5%	±0.5%
Energy mode			
Maximum measurable energy ^d	200 J	200 J	---
Noise equivalent energy ^b	0.25 J	0.25 J	---
Minimum repetition period	12 s	12 s	---
Maximum pulse width	430 ms	430 ms	---
Accuracy with energy calibration option	± 5%	± 5%	---
DAMAGE THRESHOLDS			
Maximum average power density			
1064 nm, 10 W, CW	45 kW/cm ²	45 kW/cm ²	45 kW/cm ²
1064 nm, 500 W, CW	8 kW/cm ²	8 kW/cm ²	9 kW/cm ²
1064 nm, 2500 W, CW	---	---	6 kW/cm ²
10.6 µm, 500 W, CW	---	---	4.5 kW/cm ²
10.6 µm, 1500 W, CW	---	---	3.5 kW/cm ²
10.6 µm, 2500 W, CW	---	---	3.0 kW/cm ²
Maximum energy density			
1064 nm, 360 µs, 5 Hz	9 J/cm ²	9 J/cm ²	9 J/cm ²
1064 nm, 7 ns, 10 Hz	1 J/cm ²	1 J/cm ²	1 J/cm ²
532 nm, 7 ns, 10 Hz	0.6 J/cm ²	0.6 J/cm ²	0.6 J/cm ²
266 nm, 7 ns, 10 Hz	0.3 J/cm ²	0.3 J/cm ²	0.3 J/cm ²
PHYSICAL CHARACTERISTICS			
Effective aperture	55 mm Ø	55 mm Ø	55 mm Ø
Absorber (high damage threshold)	HD	HD	HD
Dimensions	120H x 120W x 135D mm	89H x 89W x 40D mm	116H x 116W x 37D mm
Weight (head only)	2.75 kg	0.90 kg	3.3 kg
ORDERING INFORMATION			
Available output options	DB15, USB, RS-232 or Bluetooth	DB15, USB, RS-232 or Bluetooth	DB15, USB, RS-232 or Bluetooth
Compatible stand	STAND-S-443-C	STAND-S-443-C	STAND-S-443-C
Product page			

- a. Calibrations at 2.1 to 2.5 µm and 10.6 µm are available on special request.
- b. Nominal value, actual value depends on electrical noise in the measurement system.
- c. With anticipation.
- d. Including linearity with power.
- e. For 360 µs pulses. Higher pulse energy possible for long pulses (ms), less for short pulses (ns).
- f. Minimum cooling flow 1.5 l/m (UP55M-700W-HD) or 3 l/m (UP55C-2.5KW-HD), water temperature ≤22°C, 1/8 NPT compression fittings for 1/4 inch semi-rigid tube. Contact Gentec-EO for clean deionized water cooling module option.

Specifications are subject to change without notice

UP19-W

19 mm Ø, 1 mW - 85 W, 100 kW/cm²



KEY FEATURES

- > **MODULAR CONCEPT**
Increase the power capability of your detector:
4 different cooling modules
- > **VERY HIGH DAMAGE THRESHOLD**
100 kW/cm² in average power density
- > **COMPACT DESIGN**
Only 21 mm thick (15S model)
- > **ENERGY MODE**
Measure single shot energy up to 200 J

OUTPUT OPTIONS

- > **SMART DB15 CONNECTOR**
Contains all the calibration data
- > **integra ALL-IN-ONE-METER**
Connects directly to a PC
Two models available:
 - USB output (-INT)
 - RS-232 output (-IDR)
- > **BLU WIRELESS METER** 
Connects via Bluetooth® to a smartphone, tablet or PC

COMPATIBLE DISPLAYS & PC INTERFACES



MIRO ALTITUDE



MAESTRO



TUNER



UNO



U-LINK and P-LINK



S-LINK and M-LINK

ACCESSORIES



Stand with steel post



Extension cables
(4, 15, 20 or 25 m)



12V power supply



Pelican carrying case







Isolation tube



Fiber adaptors & connectors
(FC, ST and SMA)



	UP19K-15S-W5-DO	UP19K-30H-W5-DO	UP19K-50L-W5-DO	UP19K-50F-W5-DO
MAX AVERAGE POWER (CONTINUOUS / 1 MINUTE)	15 W / 30 W	30 W / 60 W	50 W / 85 W	50 W / 85 W
EFFECTIVE APERTURE	19 mm \varnothing	19 mm \varnothing	19 mm \varnothing	19 mm \varnothing
COOLING METHOD	Convection	Heatsink	Large heatsink	Fan-cooled
MEASUREMENT CAPABILITY				
Spectral range	0.19 - 10.0 μm	0.19 - 10.0 μm	0.19 - 10.0 μm	0.19 - 10.0 μm
Calibrated spectral range ^a	0.248 - 2.1 μm	0.248 - 2.1 μm	0.248 - 2.1 μm	0.248 - 2.1 μm
Noise equivalent power ^b	1 mW	1 mW	1 mW	1 mW
Rise time (nominal) ^c	1.4 s	1.4 s	1.4 s	1.4 s
Calibration uncertainty ^d	$\pm 2.5\%$	$\pm 2.5\%$	$\pm 2.5\%$	$\pm 2.5\%$
Repeatability	$\pm 0.5\%$	$\pm 0.5\%$	$\pm 0.5\%$	$\pm 0.5\%$
Energy mode				
Maximum measurable energy ^e	200 J	200 J	200 J	200 J
Noise equivalent energy ^b	0.02 J	0.02 J	0.02 J	0.02 J
Minimum repetition period	5 s	5 s	5 s	5 s
Maximum pulse width	133 ms	133 ms	133 ms	133 ms
Accuracy with energy calibration option	$\pm 5\%$	$\pm 5\%$	$\pm 5\%$	$\pm 5\%$
DAMAGE THRESHOLDS				
Maximum average power density ^f	100 kW/cm ²	100 kW/cm ²	100 kW/cm ²	100 kW/cm ²
Maximum energy density				
1064 nm, 150 μs , 10 Hz	100 J/cm ²	100 J/cm ²	100 J/cm ²	100 J/cm ²
1064 nm, 7 ns, 10 Hz	1.1 J/cm ²	1.1 J/cm ²	1.1 J/cm ²	1.1 J/cm ²
532 nm, 7 ns, 10 Hz	1.1 J/cm ²	1.1 J/cm ²	1.1 J/cm ²	1.1 J/cm ²
248 nm, 26 ns, 10 Hz	0.7 J/cm ²	0.7 J/cm ²	0.7 J/cm ²	0.7 J/cm ²
PHYSICAL CHARACTERISTICS				
Effective aperture	19 mm \varnothing	19 mm \varnothing	19 mm \varnothing	19 mm \varnothing
Absorber (high damage threshold)	W5	W5	W5	W5
Dimensions	50H x 50W x 20.6D mm	50H x 50W x 56.3D mm	76.2H x 76.2W x 73.6D mm	50H x 50W x 63D mm
Weight (head only)	0.16 kg	0.21 kg	0.48 kg	0.25 kg
ORDERING INFORMATION				
Available output options	DB15, USB, RS-232 or Bluetooth	DB15, USB, RS-232 or Bluetooth	DB15, USB or RS-232	DB15, USB, RS-232 or Bluetooth
Compatible stand	STAND-S-233	STAND-S-233	STAND-S-233	STAND-S-233
Product page				

a. Calibration at 2.1 to 2.5 μm is available on special request.
 b. Nominal value, actual value depends on electrical noise in the measurement system.
 c. With anticipation.
 d. Including linearity with power.
 e. For 150 μs pulses. Higher pulse energy possible for long pulses (ms), less for short pulses (ns).
 f. At 1064 nm, 10 W CW.

UP50-W

50 mm Ø, 5 mW - 85 W, 100 kW/cm²



KEY FEATURES

- > **MODULAR CONCEPT**
Increase the power capability of your detector:
3 different cooling modules
- > **VERY HIGH DAMAGE THRESHOLD**
100 kW/cm² in average power density
- > **VERY LARGE APERTURE**
50 mm Ø effective aperture, perfect for large beams
- > **HIGHEST ENERGY READINGS IN THE SERIES**
Measure single shot energy up to 500 J

OUTPUT OPTIONS

- > **SMART DB15 CONNECTOR**
Contains all the calibration data
- > **integra ALL-IN-ONE-METER**
Connects directly to a PC
Two models available:
 - USB output (-INT)
 - RS-232 output (-IDR)
- > **BLU WIRELESS METER** 
Connects via Bluetooth® to a smartphone, tablet or PC

COMPATIBLE DISPLAYS & PC INTERFACES



MIRO ALTITUDE



MAESTRO



TUNER



UNO



U-LINK and P-LINK



S-LINK and M-LINK

ACCESSORIES



Stand with steel post



Extension cables
(4, 15, 20 or 25 m)



Fiber adaptors and connectors
(FC, SC or SMA)



3-Port fiber cylinder with
adaptors and plug





12V power supply



Pelican carrying case



	UP50N-40S-W9-D0	UP50N-50H-W9-D0	UP50N-50F-W9-D0
MAX AVERAGE POWER (CONTINUOUS / 1 MINUTE)	40 W / 80 W	50 W / 85 W	50 W / 85 W
EFFECTIVE APERTURE	50 mm Ø	50 mm Ø	50 mm Ø
COOLING METHOD	Convection	Heatsink	Fan-cooled
MEASUREMENT CAPABILITY			
Spectral range	0.19 - 10.0 µm	0.19 - 10.0 µm	0.19 - 10.0 µm
Calibrated spectral range ^a	0.248 - 2.1 µm	0.248 - 2.1 µm	0.248 - 2.1 µm
Noise equivalent power ^b	5 mW	5 mW	5 mW
Rise time (nominal) ^c	3.5 s	3.5 s	3.5 s
Calibration uncertainty ^d	± 2.5%	± 2.5%	± 2.5%
Repeatability	±0.5%	±0.5%	±0.5%
Energy mode			
Maximum measurable energy ^e	500 J	500 J	500 J
Noise equivalent energy ^b	0.25 J	0.25 J	0.25 J
Minimum repetition period	11.1 s	11.1 s	11.1 s
Maximum pulse width	467 ms	467 ms	467 ms
Accuracy with energy calibration option	± 5%	± 5%	± 5%
DAMAGE THRESHOLDS			
Maximum average power density ^f	100 kW/cm ²	100 kW/cm ²	100 kW/cm ²
Maximum energy density			
1064 nm, 150 µs, 5 Hz	100 J/cm ²	100 J/cm ²	100 J/cm ²
1064 nm, 7 ns, 10 Hz	1.1 J/cm ²	1.1 J/cm ²	1.1 J/cm ²
532 nm, 7 ns, 10 Hz	1.1 J/cm ²	1.1 J/cm ²	1.1 J/cm ²
248 nm, 26 ns, 10 Hz	0.7 J/cm ²	0.7 J/cm ²	0.7 J/cm ²
PHYSICAL CHARACTERISTICS			
Effective aperture	50 mm Ø	50 mm Ø	50 mm Ø
Absorber (high damage threshold)	W9	W9	W9
Dimensions	89H x 89W x 38D mm	89H x 89W x 109D mm	92H x 92W x 116D mm
Weight (head only)	0.62 kg	0.93 kg	1.38 kg
ORDERING INFORMATION			
Available output options	DB15, USB, RS-232 or Bluetooth	DB15, USB, RS-232 or Bluetooth	DB15, USB, RS-232 or Bluetooth
Compatible stand	STAND-S-443	STAND-S-443	STAND-S-443
Product page			

- a. Calibration at 2.1 to 2.5 µm is available on special request.
- b. Nominal value, actual value depends on electrical noise in the measurement system.
- c. With anticipation.
- d. Including linearity with power.
- e. For 360 µs pulses. Higher pulse energy possible for long pulses (ms), less for short pulses (ns).
- f. At 1064 nm, 10 W CW.

UP16-QED

16 mm Ø, 4 mW - 100 W, volume absorber



KEY FEATURES

- > **MODULAR CONCEPT**
Increase the power capability of your detector:
3 different cooling modules
- > **HIGH PEAK POWER VOLUME ABSORBER**
Perfect for pulsed beams with high energy density
- > **COMPACT DESIGN**
Only 24 mm thick (15S model)
- > **ENERGY MODE**
Measure single shot energy up to 500 J

OUTPUT OPTIONS

- > **SMART DB15 CONNECTOR**
Contains all the calibration data
- > **integra ALL-IN-ONE-METER**
Connects directly to a PC
Two models available:
 - USB output (-INT)
 - RS-232 output (-IDR)
- > **BLU WIRELESS METER** 
Connects via Bluetooth® to a smartphone, tablet or PC

COMPATIBLE DISPLAYS & PC INTERFACES



MIRO ALTITUDE



MAESTRO



TUNER



UNO



U-LINK and P-LINK



S-LINK and M-LINK

ACCESSORIES



Stand with steel post



Extension cables
(4, 15, 20 or 25 m)



Pelican carrying case



UP16-QED

Specifications



*Also traceable to NRC-CNRC



	UP16K-15S-QED-D0	UP16K-30H-QED-D0	UP16K-100W-QED-D0
MAX AVERAGE POWER (CONTINUOUS / 1 MINUTE)	15 W / 20 W	30 W / 35 W	100 W / 100 W
EFFECTIVE APERTURE	16 mm \emptyset	16 mm \emptyset	16 mm \emptyset
COOLING METHOD	Convection	Heatsink	Water-cooled
MEASUREMENT CAPABILITY			
Spectral range	0.266 - 2.5 μm	0.266 - 2.5 μm	0.266 - 2.5 μm
Calibrated spectral range ^a	0.532 - 2.1 μm	0.532 - 2.1 μm	0.532 - 2.1 μm
Noise equivalent power ^b	4 mW	4 mW	4 mW
Rise time (nominal) ^c	2.5 s	2.5 s	2.5 s
Calibration uncertainty ^d	$\pm 2.5\%$	$\pm 2.5\%$	$\pm 2.5\%$
Repeatability	$\pm 0.5\%$	$\pm 0.5\%$	$\pm 0.5\%$
Energy mode			
Maximum measurable energy ^e	500 J	500 J	500 J
Noise equivalent energy ^b	60 mJ	60 mJ	60 mJ
Minimum repetition period	4 s	4 s	4 s
Maximum pulse width	61 ms	61 ms	61 ms
Accuracy with energy calibration option	$\pm 5\%$	$\pm 5\%$	$\pm 5\%$
DAMAGE THRESHOLDS			
Maximum average power density ^f	100 kW/cm ²	100 kW/cm ²	100 kW/cm ²
Maximum energy density			
1064 nm, 360 μs , 5 Hz	300 J/cm ²	300 J/cm ²	300 J/cm ²
1064 nm, 7 ns, 10 Hz	8 J/cm ²	8 J/cm ²	8 J/cm ²
532 nm, 7 ns, 10 Hz	6 J/cm ²	6 J/cm ²	6 J/cm ²
266 nm, 7 ns, 10 Hz	1 J/cm ²	1 J/cm ²	1 J/cm ²
PHYSICAL CHARACTERISTICS			
Effective aperture	16 mm \emptyset	16 mm \emptyset	16 mm \emptyset
Absorber (volume absorber)	QED	QED	QED
Dimensions	50H x 50W x 23.6D mm	50H x 50W x 59D mm	50H x 50W x 38D
Weight (head only)	0.16 kg	0.21 kg	0.24 kg
ORDERING INFORMATION			
Available output options	DB15, USB, RS-232 or Bluetooth	DB15, USB, RS-232 or Bluetooth	DB15, USB, RS-232 or Bluetooth
Compatible stand	STAND-S-233	STAND-S-233	STAND-S-233
Product page			

- a. Calibration at 2.1 to 2.5 μm is available on special request.
- b. Nominal value, actual value depends on electrical noise in the measurement system.
- c. With anticipation.
- d. Including linearity with power.
- e. For 360 μs pulses. Higher pulse energy possible for long pulses (ms), less for short pulses (ns).
- f. At 1064 nm, 10 W CW.

Specifications are subject to change without notice

UP52-QED

52 mm Ø, 15 mW - 300 W, volume absorber



KEY FEATURES

- > **MODULAR CONCEPT**
Increase the power capability of your detector:
4 different cooling modules
- > **HIGH PEAK POWER VOLUME ABSORBER**
Perfect for pulsed beams with high energy density
- > **LARGE APERTURE**
52 mm Ø aperture accommodates large beams
- > **HIGH AVERAGE POWER**
Up to 300 W of continuous power with the
water-cooled unit
- > **ENERGY MODE**
Measure single shot energy up to 1000 J

OUTPUT OPTIONS

- > **SMART DB15 CONNECTOR**
Contains all the calibration data
- > **integra ALL-IN-ONE-METER**
Connects directly to a PC
Two models available:
 - USB output (-INT)
 - RS-232 output (-IDR)
- > **BLU WIRELESS METER** 
Connects via Bluetooth® to a smartphone, tablet or PC

COMPATIBLE DISPLAYS & PC INTERFACES



MIRO ALTITUDE



MAESTRO



TUNER



UNO



U-LINK and P-LINK



S-LINK and M-LINK

ACCESSORIES



Stand with steel post



Extension cables
(4, 15, 20 or 25 m)



12V power supply







Pelican carrying case

UP52-QED

Specifications



	UP52N-50S-QED-D0	UP52N-100H-QED-D0	UP52N-150F-QED-D0	UP52M-300W-QED-D0
MAX AVERAGE POWER (CONTINUOUS / 1 MINUTE)	50 W / 50 W	100 W / 100 W	150 W / 150 W	300 W ^f / 300 W ^f
EFFECTIVE APERTURE	52 mm Ø	52 mm Ø	52 mm Ø	52 mm Ø
COOLING METHOD	Convection	Heatsink	Fan-cooled	Water-cooled
MEASUREMENT CAPABILITY				
Spectral range	0.266 - 2.5 µm	0.266 - 2.5 µm	0.266 - 2.5 µm	0.266 - 2.5 µm
Calibrated spectral range^a	0.300 - 2.1 µm	0.300 - 2.1 µm	0.300 - 2.1 µm	0.300 - 2.1 µm
Noise equivalent power^b	15 mW	15 mW	15 mW	15 mW
Rise time (nominal)^c	4 s	4 s	4 s	4 s
Calibration uncertainty^d	± 2.5%	± 2.5%	± 2.5%	± 2.5%
Repeatability	±0.5%	±0.5%	±0.5%	±0.5%
Energy mode				
Maximum measurable energy ^e	1000 J	1000 J	1000 J	1000 J
Noise equivalent energy ^b	250 mJ	250 mJ	250 mJ	250 mJ
Minimum repetition period	9 s	9 s	9 s	9 s
Maximum pulse width	371 ms	371 ms	371 ms	371 ms
Accuracy with energy calibration option	± 5%	± 5%	± 5%	± 5%
DAMAGE THRESHOLDS				
Maximum average power density^g	100 kW/cm ²	100 kW/cm ²	100 kW/cm ²	100 kW/cm ²
Maximum energy density				
1064 nm, 360 µs, 5 Hz	300 J/cm ²	300 J/cm ²	300 J/cm ²	300 J/cm ²
1064 nm, 7 ns, 10 Hz	8 J/cm ²	8 J/cm ²	8 J/cm ²	6 J/cm ²
532 nm, 7 ns, 10 Hz	6 J/cm ²	6 J/cm ²	6 J/cm ²	6 J/cm ²
266 nm, 7 ns, 10 Hz	1 J/cm ²	1 J/cm ²	1 J/cm ²	1 J/cm ²
PHYSICAL CHARACTERISTICS				
Effective aperture	52 mm Ø	52 mm Ø	52 mm Ø	52 mm Ø
Absorber (volume absorber)	QED	QED	QED	QED
Dimensions	89H x 89W x 32D mm	89H x 89W x 106D mm	89H x 89W x 116D mm	89H x 89W x 43D mm
Weight (head only)	0.62 kg	0.93 kg	1.41 kg	0.84 kg
ORDERING INFORMATION				
Available output options	DB15, USB, RS-232 or Bluetooth	DB15, USB, RS-232 or Bluetooth	DB15, USB, RS-232 or Bluetooth	DB15, USB, RS-232 or Bluetooth
Compatible stand	STAND-S-443	STAND-S-443	STAND-S-443	STAND-S-443
Product page				

- a. Calibrations at 2.1 to 2.5 µm and 10.6 µm are available on special request.
 b. Nominal value, actual value depends on electrical noise in the measurement system.
 c. With anticipation.
 d. Including linearity with power.
 e. For 360 µs pulses. Higher pulse energy possible for long pulses (ms), less for short pulses (ns).
 f. Minimum cooling flow 1 liters/min, water temperature ≤ 22 °C, 1/8 NPT compression fittings for 1/4 inch semi-rigid tube. Contact Gentec-EO for clean deionized water cooling module option.
 g. At 1064 nm, 10 W CW.

IS

Integrating sphere detector for laser power measurement up to 1 kW

New product



KEY FEATURES

- **FASTEST RESPONSE**
With its silicon sensor, the integrating sphere is as fast as a photodiode.
- **WIDE POWER RANGE**
Very low noise level = wide power range with just one device
- **HIGH AVERAGE POWER**
Measure up to 1000 W of continuous power.
- **RESISTANT COATING**
Our proprietary coating is designed to be strong. Its damage thresholds are orders of magnitude higher than any other "white" coatings on the market.
- **PRECISE CALIBRATION**
The IS detectors have a NIST-traceable calibration for the entire calibrated spectral range.

OUTPUT OPTIONS

- **integra ALL-IN-ONE-METER**
Connects directly to a PC
Two models available:
 - USB output (-INT)
 - RS-232 output (-IDR)

COMPATIBLE PC INTERFACES



INTEGRA

ACCESSORIES



Stand with delrin post



Fiber adaptors & connectors
(for IS12L only)



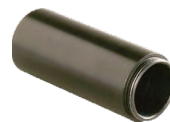

Pelican carrying case



Isolation tube
(for IS12L only)



	IS12L-9S-RSI-INT-DO	IS50A-1KW-RSI-INT-DO
MAXIMUM AVERAGE POWER	9 W	1000 W
EFFECTIVE APERTURE	12 mm \varnothing	50 mm \varnothing
COOLING METHOD	Convection	Water
MEASUREMENT CAPABILITY		
Spectral range	340 - 1100 nm	340 - 1100 nm
Calibrated spectral range	400 - 1070 nm	400 - 1070 nm
Maximum average power	9 W	1000 W
Noise equivalent power ^a	1 μ W at 1070 nm	10 μ W at 1070 nm
Maximum divergence	10° (half-angle)	10° (half-angle)
Maximum incidence angle	\pm 10°	\pm 25° for beam diameter < \varnothing 12mm \pm 5° for beam diameter > \varnothing 12mm
Typical rise time	< 0.2 s	< 0.2 s
Sampling rate	15 Hz	15 Hz
Calibration uncertainty	\pm 5.0% (400 - 499 nm) \pm 3.5% (500 - 1069 nm) \pm 2.5% (1070 nm)	\pm 5.0% (400 - 499 nm) \pm 3.5% (500 - 1069 nm) \pm 2.5% (1070 nm)
Back reflections ^b	6%	12%
Linearity with power	\pm 1%	\pm 1%
DAMAGE THRESHOLDS		
Maximum average power density ^c	2 kW/cm ²	5 kW/cm ²
Maximum energy density ^d	400 mJ/cm ²	400 mJ/cm ²
PHYSICAL CHARACTERISTICS		
Effective aperture	12 mm \varnothing	50 mm \varnothing
Mounting thread	SM1	SM2
Sphere inner diameter	50 mm \varnothing	100 mm \varnothing
Sensor	Silicon	Silicon
Dimensions	66H x 78W x 66D mm	127H x 140W x 115D mm
Weight	0.75 kg	4 kg
ORDERING INFORMATION		
Available output options	USB or RS-232	USB or RS-232
Compatible stand	STAND-S-443	STAND-S-443-C
Product page		

a. Nominal value. Actual value depends on environmental electromagnetic interference and wavelength. With anticipation.
 b. The backscattered power (also known as back reflections) is concentrated in a cone with an apex located at the back of the sphere. For IS12, the cone has a 7.5-degree half-angle. For IS50, the cone has a 15-degree half-angle.
 c. At 1064 - 1070 nm, CW.
 d. At 1064 - 1070 nm, 7 ns.

HP60

60 mm Ø with cone reflector, 300 W - 15 000 W



New product



KEY FEATURES

- > **HIGH POWER HANDLING**
Handles up to 15 kW of continuous power. Custom models available for higher powers. The new HP60A-15KW-GD-QBH is designed for use with QB/QBH high power fibers.
- > **LOW BACK REFLECTIONS**
The cone reflector traps most of the incident laser power inside the detector head. With its TUBE extension, the HP60A-15KW-GD-TUBE has the lowest back reflection rating: under 2%.
- > **AVAILABLE WITH YAG AND CO₂ CALIBRATIONS**
All HP models can be calibrated at YAG and CO₂ wavelengths with a calibration uncertainty of $\pm 5\%$
- > **DIRECT USB CONNECTION TO A PC**
Each head comes with both a DB15 connector (for use with a Gentec-EO display device) and a USB output for direct connection to a PC
- > **TRACK WATER PARAMETERS**
Water flow and temperature are monitored in real time and displayed continuously

OUTPUT OPTIONS

- > **SMART DB15 CONNECTOR**
Contains all the calibration data
- > **USB PORT**
 - Connects directly to a PC
 - Included in all HP models
- > **BLU WIRELESS METER** 
Connects via Bluetooth to a PC

COMPATIBLE DISPLAYS & PC INTERFACES



MIRO ALTITUDE



MAESTRO



TUNER



UNO

ACCESSORIES



Stand with steel post



Extension cables
(4, 15, 20 or 25 m)*



5 m USB cable
(Included)



Water filter
(Metric: 202984, Imperial: 202990)



Pelican carrying case

*A USB power adaptor will be necessary if the HP is used with a DB15 extension cable.



	HP60A-10KW-GD	HP60A-15KW-GD	HP60A-15KW-GD-TUBE	HP60A-15KW-GD-QBH
MAX AVERAGE POWER	10 kW	15 kW	15 kW	15 kW
EFFECTIVE APERTURE	60 mm Ø	60 mm Ø	70 mm Ø	QB/QBH fiber adaptor
COOLING METHOD	Water-cooled	Water-cooled	Water-cooled	Water-cooled

MEASUREMENT CAPABILITY				
Spectral range	0.8 - 12 µm	0.8 - 12 µm	0.8 - 12 µm	0.8 - 12 µm
Calibrated spectral range ^a	0.8 - 2.1 µm	0.8 - 2.1 µm	0.8 - 2.1 µm	0.8 - 2.1 µm
Noise equivalent power ^b	10 W	15 W	15 W	15 W
Minimum average power ^c	300 W	500 W	500 W	500 W
Rise time (nominal)	12 s	15 s	15 s	15 s
Back reflections	10%	5 - 10%	1 - 2%	1 - 2%
Calibration uncertainty	± 5% at 1064 nm & 1070 nm	± 5% at 1064 nm & 1070 nm	± 5% at 1064 nm & 1070 nm	± 5% at 1064 nm & 1070 nm
Repeatability	± 2%	± 2%	± 2%	± 2%
Linearity with power	± 2%	± 2%	± 2%	± 2%
Linearity with beam diameter	± 2.0%	± 2.5%	± 2.5%	± 2.5%
Linearity with beam position ^d	± 3.0%	± 4.0%	± 4.0%	± 4.0%

DAMAGE THRESHOLDS				
Maximum average power density ^e				
1 kW	70 kW/cm ²	70 kW/cm ²	70 kW/cm ²	70 kW/cm ²
5 kW	35 kW/cm ²	35 kW/cm ²	35 kW/cm ²	35 kW/cm ²
10 kW	20 kW/cm ²	20 kW/cm ²	20 kW/cm ²	20 kW/cm ²
15 kW		10 kW/cm ²	10 kW/cm ²	10 kW/cm ²

PHYSICAL CHARACTERISTICS				
Effective aperture	60 mm Ø	60 mm Ø	70 mm Ø tube aperture	QB/QBH fiber adaptor
Absorber	GD (cone reflector)	GD (cone reflector)	GD (cone reflector)	GD (cone reflector)
Cooling water				
Required cooling flow ^f	(6 - 8) LPM < ± 1 LPM/min	(8 - 10) LPM < ± 1 LPM/min	(8 - 10) LPM < ± 1 LPM/min	(8 - 10) LPM < ± 1 LPM/min
Temperature range	15 - 25 °C	15 - 25 °C	15 - 25 °C	15 - 25 °C
Rate of temperature change	< ± 3°C/min	< ± 3°C/min	< ± 3°C/min	< ± 3°C/min
Maximum water pressure (input)	413 kPa (60 psi)	413 kPa (60 psi)	413 kPa (60 psi)	413 kPa (60 psi)
Dimensions	127H x 127W x 95D mm	153H x 153W x 97D mm	153H x 153W x 302D mm	153H x 153W x 302D mm
Weight	6 kg	10 kg	15 kg	15 kg

ORDERING INFORMATION				
Available output options	DB15 & USB or Bluetooth & USB	DB15 & USB or Bluetooth & USB	DB15 & USB or Bluetooth & USB	DB15 & USB or Bluetooth & USB
Compatible stand	STAND-S-443-C	2x STAND-S-443-C	3x STAND-S-443-C	3x STAND-S-443-C
Product page				

a. Calibrations at 2.1 to 2.5 µm and 10.6 µm are available on special request.
 b. Nominal value, actual value depends on electrical noise in the measurement system.
 c. For lower powers, call your Gentec-EO representative.
 d. For a beam size of 20% of the aperture area, moved across 80% of the aperture area.
 e. At 1064 nm, 1.07-1.08 µm and 10.6 µm, for beams < 50 mm Ø.
 f. > 1 min. contact Gentec-EO for deionized water cooling module option.

HP100

Up to 125 x 125 mm, 100 W - 15 kW

New product



KEY FEATURES

- > **HIGH POWER HANDLING**
Handles up to 15 kW of continuous power with our standard models. Custom models available for higher powers (See SUPER HP)
- > **LARGE APERTURE**
Our standard HP models have very large effective apertures to accommodate large laser beams. Larger apertures with various shapes are available upon request (See SUPER HP)
- > **AVAILABLE WITH YAG AND CO₂ CALIBRATIONS**
All HP Models can be calibrated at YAG and CO₂ wavelengths with a calibration uncertainty of $\pm 5\%$
- > **DIRECT USB CONNECTION TO A PC**
Each head comes with both a DB15 connector (for use with a Gentec-EO display device) and a USB output for direct connection to a PC
- > **TRACK WATER PARAMETERS**
Water flow and temperature are monitored in real time and displayed continuously

OUTPUT OPTIONS

- > **SMART DB15 CONNECTOR**
Contains all the calibration data
- > **USB PORT**
 - Connects directly to a PC
 - Included in all HP models
- > **BLU WIRELESS METER** 
Connects via Bluetooth to a PC

COMPATIBLE DISPLAYS & PC INTERFACES



MIRO ALTITUDE



MAESTRO



TUNER



UNO

ACCESSORIES



Stand with steel post



Extension cables
(4, 15, 20 or 25 m)*



5 m USB cable
(Included)



Water filter
(Metric: 202984, Imperial: 202990)



Pelican carrying case

*A USB power adaptor will be necessary if the HP is used with a DB15 extension cable.



	HP100A-4KW-HE	HP100A-4KW-HE-TUBE	HP100A-12KW-HD	HP100A-12KW-HD-TUBE	HP125A-15KW-HD	HP125A-15KW-HD-TUBE
MAX AVERAGE POWER	4000 W	4000 W	12 000 W	12 000 W	15 000 W	15 000 W
EFFECTIVE APERTURE	100 mm ϕ	70 mm ϕ	100 mm ϕ	70 mm ϕ	125 x 125 mm	70 mm ϕ
COOLING METHOD	Water-cooled	Water-cooled	Water-cooled	Water-cooled	Water-cooled	Water-cooled

MEASUREMENT CAPABILITY

Spectral range	0.19 - 20 μm	0.19 - 20 μm	0.19 - 20 μm	0.19 - 20 μm	0.19 - 20 μm	0.19 - 20 μm
Calibrated spectral range ^a	0.248 - 2.1 μm	0.248 - 2.1 μm	0.248 - 2.1 μm	0.248 - 2.1 μm	0.248 - 2.1 μm	0.248 - 2.1 μm
Noise equivalent power ^b	± 3 W	± 3 W	± 10 W	± 10 W	± 15 W	± 15 W
Minimum average power ^c	100 W	100 W	300 W	300 W	500 W	500 W
Rise time (nominal)	7 s	7 s	9 s	9 s	15 s	15 s
Back reflections	10-15%	< 4%	10 - 15%	< 4%	10 - 15%	2 - 4%
Calibration uncertainty ^d	± 5	$\pm 5\%$	$\pm 5\%$	$\pm 5\%$	$\pm 5\%$	$\pm 5\%$
Repeatability	$\pm 2\%$	$\pm 2\%$	$\pm 2\%$	$\pm 2\%$	$\pm 2\%$	$\pm 2\%$
Linearity with power	$\pm 1.5\%$	$\pm 1.5\%$	$\pm 1.5\%$	$\pm 1.5\%$	$\pm 2\%$	$\pm 2\%$
Linearity vs beam diameter	$\pm 1\%$	$\pm 1\%$	$\pm 1\%$	$\pm 1\%$	$\pm 1\%$	$\pm 1\%$
Linearity vs beam position ^e	$\pm 1.7\%$	$\pm 1.7\%$	$\pm 1.7\%$	$\pm 1.7\%$	$\pm 1.0\%$	$\pm 1.0\%$

DAMAGE THRESHOLDS







Maximum average power density ^f

500 W	10 kW/cm ²	10 kW/cm ²	16 kW/cm ²	16 kW/cm ²	16 kW/cm ²	16 kW/cm ²
4 kW	4 kW/cm ²	4 kW/cm ²	---	---	---	---
5 kW	---	---	6.5 kW/cm ²	6.5 kW/cm ²	6.5 kW/cm ²	6.5 kW/cm ²
10 kW	---	---	3.5 kW/cm ²	3.5 kW/cm ²	3.5 kW/cm ²	3.5 kW/cm ²
15 kW	---	---	---	---	1.5 kW/cm ²	1.5 kW/cm ²

PHYSICAL CHARACTERISTICS

Effective aperture	100 mm ϕ	70 mm ϕ	100 mm ϕ	70 mm ϕ	125 x 125 mm	70 mm
Absorber (high damage threshold)	HE	HE	HD	HD	HD	HD
Cooling water						
Required cooling flow ^g	(4 - 6) LPM < ± 1 LPM/min	(4 - 6) LPM < ± 1 LPM/min	(6 - 10) LPM < ± 1 LPM/min	(6 - 10) LPM < ± 1 LPM/min	(8 - 10) LPM < ± 1 LPM/min	(8 - 10) LPM < ± 1 LPM/min
Temperature range	15 - 25 $^{\circ}\text{C}$	15 - 25 $^{\circ}\text{C}$	15 - 25 $^{\circ}\text{C}$	15 - 25 $^{\circ}\text{C}$	15 - 25 $^{\circ}\text{C}$	15 - 25 $^{\circ}\text{C}$
Rate of temperature change	< $\pm 3^{\circ}\text{C}/\text{min}$	< $\pm 3^{\circ}\text{C}/\text{min}$	< $\pm 3^{\circ}\text{C}/\text{min}$	< $\pm 3^{\circ}\text{C}/\text{min}$	< $\pm 3^{\circ}\text{C}/\text{min}$	< $\pm 3^{\circ}\text{C}/\text{min}$
Maximum water pressure (input)	413 kPa (60 psi)	413 kPa (60 psi)	413 kPa (60 psi)	413 kPa (60 psi)	413 kPa (60 psi)	413 kPa (60 psi)
Dimensions	127H x 127W x 74D mm	127H x 127W x 234D mm	127H x 127W x 70D mm	127H x 127W x 230D mm	153H x 153W x 70D mm	153H x 153W x 272D mm
Weight (head only)	1.8 kg	6.0 kg	3.3 kg	7.5 kg	5 kg	10 kg

ORDERING INFORMATION

Available output options	DB15 & USB or Bluetooth & USB	DB15 & USB or Bluetooth & USB	DB15 & USB or Bluetooth & USB	DB15 & USB or Bluetooth & USB	DB15 & USB or Bluetooth & USB	DB15 & USB or Bluetooth & USB
Compatible stand	STAND-S-443-C	2x STAND-S-443-C	STAND-S-443-C	2x STAND-S-443-C	2x STAND-S-443-C	3x STAND-S-443-C
Product page						

- a. Calibrations at 2.1 to 2.5 μm and 10.6 μm are available on special request.
- b. Nominal value, actual value depends on electrical noise in the measurement system.
- c. For lower powers, call your Gentec-EO representative.
- d. At 1064 nm and 1070 nm
- e. For a beam size of 20% of the aperture area, moved across 80% of the aperture area.
- f. At 1064 nm, 1.07-1.08 μm and 10.6 μm .
- g. >1 min. Contact Gentec-EO for deionized water cooling module option.

Specifications are subject to change without notice

SUPER HP

Custom sizes and shapes, up to 120 000 W upon request



KEY FEATURES

- > **THE HIGHEST POWER HANDLING**
Custom models handle up to 120 000 W of continuous power
- > **INFINITE CUSTOMIZATION CAPABILITIES**
 1. Choose YOUR size
 2. Choose YOUR maximum power
 3. We will customize one just for you!
- > **COMPACT AND LIGHT WEIGHT**
Lighter and more compact than any other high power detector on the market, thanks to our unique design
- > **AVAILABLE WITH YAG AND CO₂ CALIBRATIONS**
All HP models can be calibrated at YAG and CO₂ wavelengths with a calibration uncertainty of $\pm 5\%$
- > **DIRECT USB CONNECTION TO A PC**
Each head comes with both a DB15 connector (for use with a Gentec-EO display device) and a USB2.0 output for direct connection to a PC. Other connectors available upon request
- > **TRACK WATER PARAMETERS**
Water flow and temperature are monitored in real time and displayed continuously
- > **HIGH POWER NIST-TRACEABLE CALIBRATION WITH A 5 KW FIBER LASER**

OUTPUT OPTIONS

- > **SMART DB15 CONNECTOR**
Contains all the calibration data
- > **USB PORT**
 - Connects directly to a PC
 - Included in all HP models
- > **BLU WIRELESS METER** 
Connects via Bluetooth to a PC

COMPATIBLE DISPLAYS & PC INTERFACES



MIRO ALTITUDE



MAESTRO



TUNER



UNO

ACCESSORIES



Stand with steel post
For 30 kW model



Extension cables
(4, 15, 20 or 25 m)





5 m USB cable
(Included)

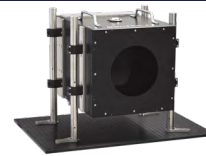

Pelican carrying case



HP280A-30KW-HD		CUSTOMIZATION CAPABILITIES
MAX AVERAGE POWER	30 000 W	Up to 120 000 W
EFFECTIVE APERTURE	280 x 280 mm	Up to 500 x 500 mm
COOLING METHOD	Water-cooled	Water-cooled
MEASUREMENT CAPABILITY		
Spectral range	0.19 - 20 μm	0.19 - 20 μm
Calibrated spectral range ^a	1.064 - 1.070 μm	1.064 - 1.070 μm
Noise equivalent power ^b	± 30 W	Adapted to maximum power
Minimum average power ^c	1000 W	Adapted to maximum power
Rise time (nominal)	25 s	≤ 45 s
Calibration uncertainty ^d	$\pm 5\%$	$\pm 5\%$
Repeatability	$\pm 2\%$	$\pm 2\%$
Linearity with power	$\pm 2\%$	$\pm 2\%$
DAMAGE THRESHOLDS		
Maximum average power density ^e		
10 kW	2.5 kW/cm ²	2.5 kW/cm ²
30 kW	0.2 kW/cm ²	0.2 kW/cm ²
PHYSICAL CHARACTERISTICS		
Effective aperture	280 x 280 mm	Square apertures up to 400 x 400 mm Rectangular and round apertures also available
Absorber (high damage threshold)	HD	HD
Cooling water		
Required cooling flow	0-30 kW: (15 - 18) LPM $\leq \pm 1$ LPM/min ^f 0-10 kW: (12-15) LPM $\leq \pm 1$ LPM/min ^f	Adapted to maximum power
Temperature range	15 - 25 °C	15 - 25 °C
Rate of temperature change	$\leq \pm 3^\circ\text{C}/\text{min}$	$\leq \pm 3^\circ\text{C}/\text{min}$
Dimensions	314H x 324W x 89D mm	
Weight (head only)	20 kg	
ORDERING INFORMATION		
Available output options	DB15 & USB or Bluetooth & USB	DB15 & USB or Bluetooth & USB
Compatible stand	STAND HP280A-30KW-HD	Ask
Product page		

a. Calibrations at 0.248 to 2.5 μm and 10.6 μm are available on special request.
 b. Nominal value, actual value depends on electrical noise in the measurement system.
 c. For lower powers, call your Gentec-EO representative.
 d. At 1064 nm and 1070 nm.
 e. At 1064 nm, 1.07-1.08 μm and 10.6 μm .
 f. > 1 min

HIGH-POWER PRONTO

1 W - 10 kW high power probes with touchscreen controls



KEY FEATURES

- **WIDE POWER RANGE**
Very low noise level = wide power range with just one device
- **CONTINUOUS READINGS AT LOW POWERS**
The PRONTO-500 includes a continuous power mode (CWP) for measurements up to 40 W.
- **NO-WAIT MEASUREMENTS**
5 seconds measurements allow for very short cooling time (all models except PRONTO-3K)
- **EASY TO USE**
The color LCD touchscreen allows for a friendly user interface. You can make a measurement with just the touch of a button!
- **DATA LOGGING**
Save your data to the internal memory and then transfer them to your PC over the USB connection.
- **LARGE APERTURE**
55 mm Ø aperture to accommodate large beams
- **RUGGED**
 - All-metal body
 - High damage thresholds
- **SERIAL COMMANDS**
Serial commands are available to let you take full control of your PRONTO from your PC.

USER INTERFACES (SSP MODE)

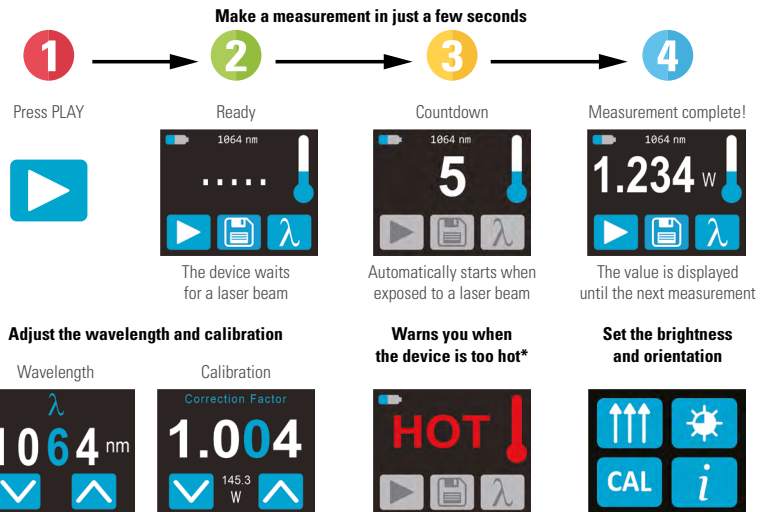

ACCESSORIES



Stand with steel post



Pelican carrying case

HIGH-POWER PRONTO

Specifications



*Also traceable to NRC-CNRC



	PRONTO-500	PRONTO-3K	PRONTO-6K	PRONTO-10K
MAX AVERAGE POWER				
SSP Mode (Measures Power in 5 s)	500 W	3000 W	6000 W	10 000 W
CWP Mode (Measures Power continuously)	40 W	N/A	N/A	N/A
EFFECTIVE APERTURE				
	55 mm \varnothing	55 mm \varnothing	55 mm \varnothing	55 mm \varnothing
COOLING METHOD				
	Convection	Convection	Convection	Convection
MEASUREMENT CAPABILITY				
Spectral range	0.19 - 20 μm	0.19 - 20 μm	0.19 - 20 μm	0.19 - 20 μm
Calibrated spectral range ^a	0.248 - 2.5 μm	0.248 - 2.5 μm	0.248 - 2.5 μm	0.248 - 2.5 μm
Noise equivalent power	0.1 W	5 W	20 W	30 W
Exposure time	5 s ^b	10 s	5 s	5 s
Calibration uncertainty	$\pm 3\%$ ($\pm 2.5\%$ in CWP mode)	$\pm 5\%$	$\pm 5\%$	$\pm 5\%$
Number of readings before cooling ^c (Maximum exposure time before cooling)	100 W	25 (200 s)	0.5 kW	6 (72 s)
	200 W	12 (100 s)	1 kW	3 (36 s)
	300 W	8 (60 s)	1.5 kW	2 (24 s)
	500 W	5 (40 s)	3 kW	1 (12 s)
	6 kW	1 (6 s)	10 kW	1 (6 s)
DAMAGE THRESHOLDS				
Maximum average power density				
1064 nm, 100 W, CW	25 kW/cm ²	---	---	---
1064 nm, 500 W, CW	5 kW/cm ²	7 kW/cm ²	---	---
1064 nm, 3000 W, CW	---	5 kW/cm ²	8 kW/cm ²	---
1064 nm, 6000 W, CW	---	---	7 kW/cm ²	7 kW/cm ²
1064 nm, 10 000 W, CW	---	---	-	5.5 kW/cm ²
Maximum allowable casing temperature				
	65 °C	65 °C	75 °C	75 °C
GENERAL SPECIFICATIONS				
Display type	Touchscreen color LCD	Touchscreen color LCD	Touchscreen color LCD	Touchscreen color LCD
Display size	28.0 x 35.0 mm (128 x 160 pixels)	28.0 x 35.0 mm (128 x 160 pixels)	28.0 x 35.0 mm (128 x 160 pixels)	28.0 x 35.0 mm (128 x 160 pixels)
Data storage	50 000 pts	50 000 pts	50 000 pts	50 000 pts
Battery type	Rechargeable Li-ion	Rechargeable Li-ion	Rechargeable Li-ion	Rechargeable Li-ion
Battery life	17 hours or 4 200 measurements (with brightness set at 25%)	17 hours or 4 200 measurements (with brightness set at 25%)	17 hours or 4 200 measurements (with brightness set at 25%)	17 hours or 4 200 measurements (with brightness set at 25%)
Battery recharge via	USB port	USB port	USB port	USB port
PHYSICAL CHARACTERISTICS				
Effective aperture	55 mm \varnothing	55 mm \varnothing	55 mm \varnothing	55 mm \varnothing
Dimensions (sensor head)	88W x 88L x 32D mm	88W x 88L x 43D mm	88W x 88L x 36D mm	88W x 88L x 46D mm
Dimensions (monitor)	41W x 140L x 16D mm	41W x 140L x 16D mm	41W x 140L x 16D mm	41W x 140L x 16D mm
Weight	930 g	1240 g	1520 g	2150 g
ORDERING INFORMATION				
Compatible stand	STAND-S-443	STAND-S-443	STAND-S-443	STAND-S-443
Product page				

a. For calibration at 10.6 μm , add C02-CAL-UP-2 to the order
 b. Response time in CWP mode is 2 s.
 c. Assuming an exposure time of 8 seconds and for 25°C starting temperature.

BD

Water-cooled beam dumps for high power lasers



KEY FEATURES

- > **EASY TO USE**
Just plug the water-cooling and you're done!
- > **2 MODELS TO CHOOSE FROM**
 - 4 kW : BD-4KW-HE
 - 12 kW : BD-12KW-HD
- > **VERY LARGE APERTURE**
The round aperture of 100 mm in diameter accommodates even the largest beams
- > **HIGH DAMAGE THRESHOLDS**
Up to 16 kW/cm² (at 500 W)
- > **ISOLATION TUBE IN OPTION**
It is possible to add an isolation tube to reduce back reflections

REDUCE BACK-REFLECTIONS

All BD models can be fitted with a water-cooled absorbing TUBE to reduce the back-reflections below 4%. The TUBE extension is backward-compatible so it can be added to your current BD unit.



ACCESSORIES



Stand with steel post





Pelican carrying case



Water filter
(Metric: 202984,
Imperial: 202990)



	BD-4KW-HE	BD-12KW-HD
MAX AVERAGE POWER (CONTINUOUS / 2 MINUTES)	4000 W / 4500 W	12 000 W / 12 000 W
EFFECTIVE APERTURE	100 mm ϕ	100 mm ϕ
COOLING METHOD	Water-cooled	Water-cooled
DAMAGE THRESHOLDS		
Maximum average power density ^a		
500 W	10 kW/cm ²	16 kW/cm ²
4 kW	4 kW/cm ²	---
5 kW	---	6.5 kW/cm ²
10 kW	---	3.5 kW/cm ²
PHYSICAL CHARACTERISTICS		
Effective aperture	100 mm ϕ	100 mm ϕ
Absorber (high damage threshold)	HE	HD
Cooling water		
Required cooling flow	(4 - 6) LPM	(6 - 10) LPM
Temperature range	(15 - 25) °C	(15 - 25) °C
Dimensions	127H x 127W x 74D mm	127H x 127W x 70D mm
Weight (head only)	1.8 kg	3.3 kg
ORDERING INFORMATION		
Compatible stand	STAND-S-443-C	STAND-S-443-C
Product page		

a. At 1064 nm, 1.07-1.08 μ m and 10.6 μ m.

ABSORPTION CURVES

XLP12-H, UP-H, PRONTO (all PRONTO except PRONTO-SI and PRONTO-50-W5)

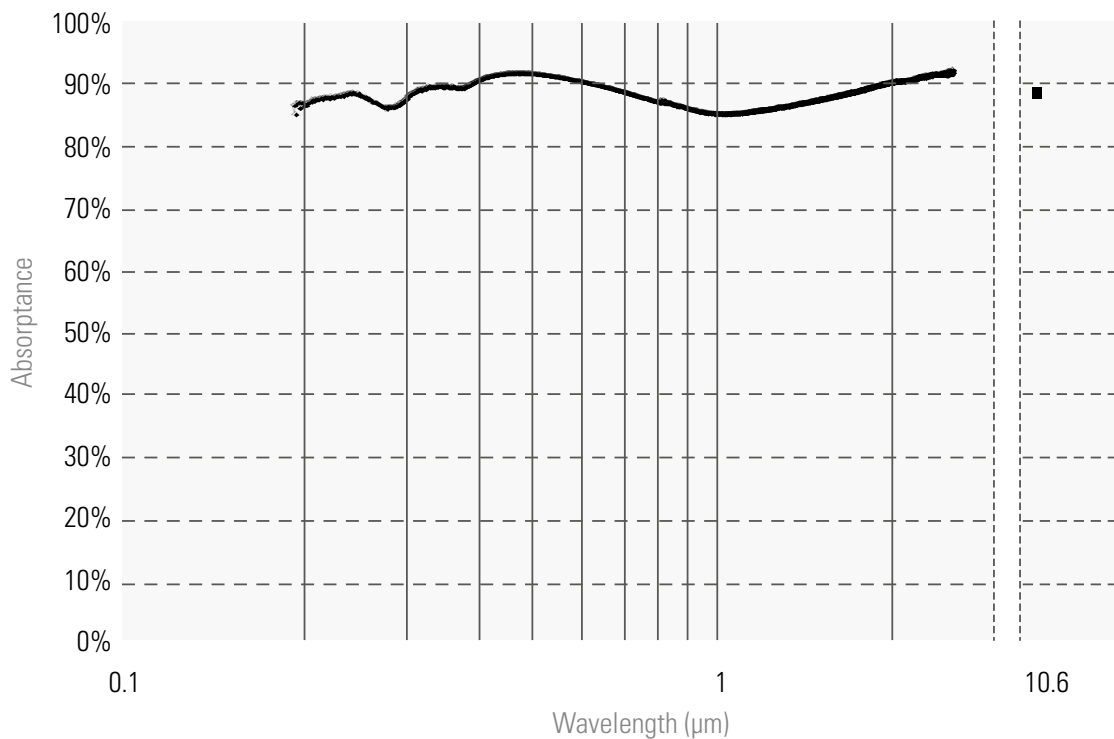

XLP12-VP

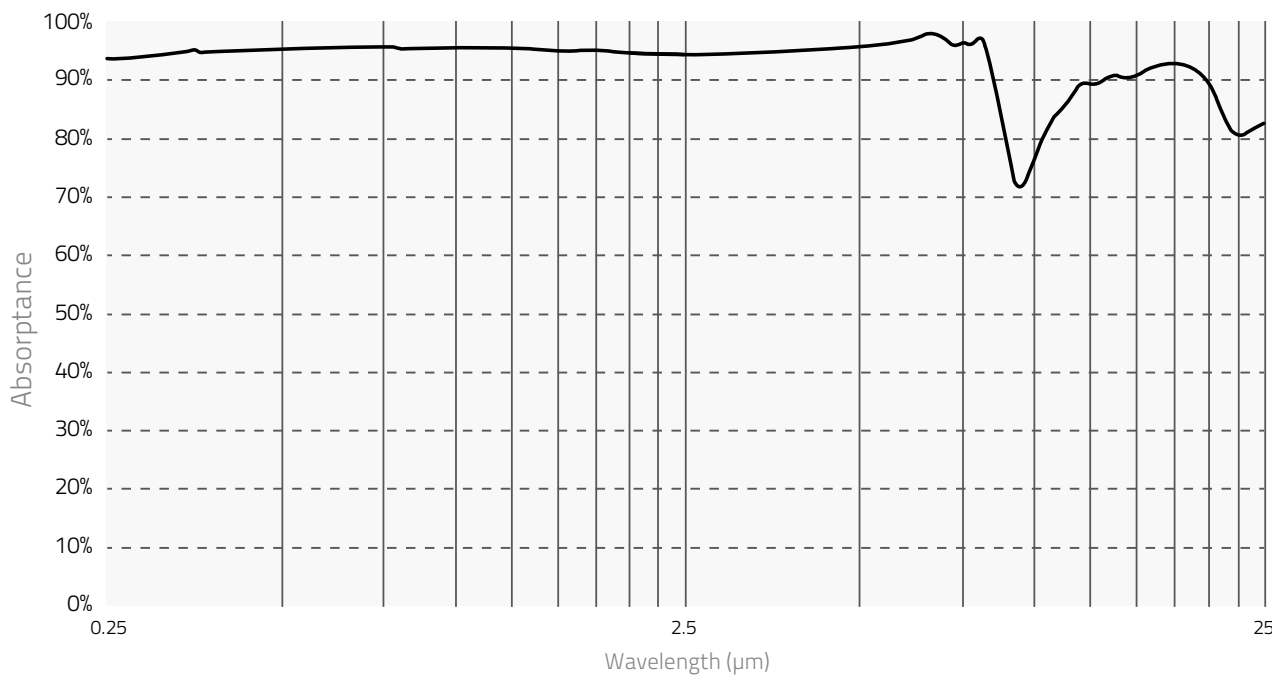

ABSORPTION CURVES

UP-W & PRONTO-50-W5



UP-QED

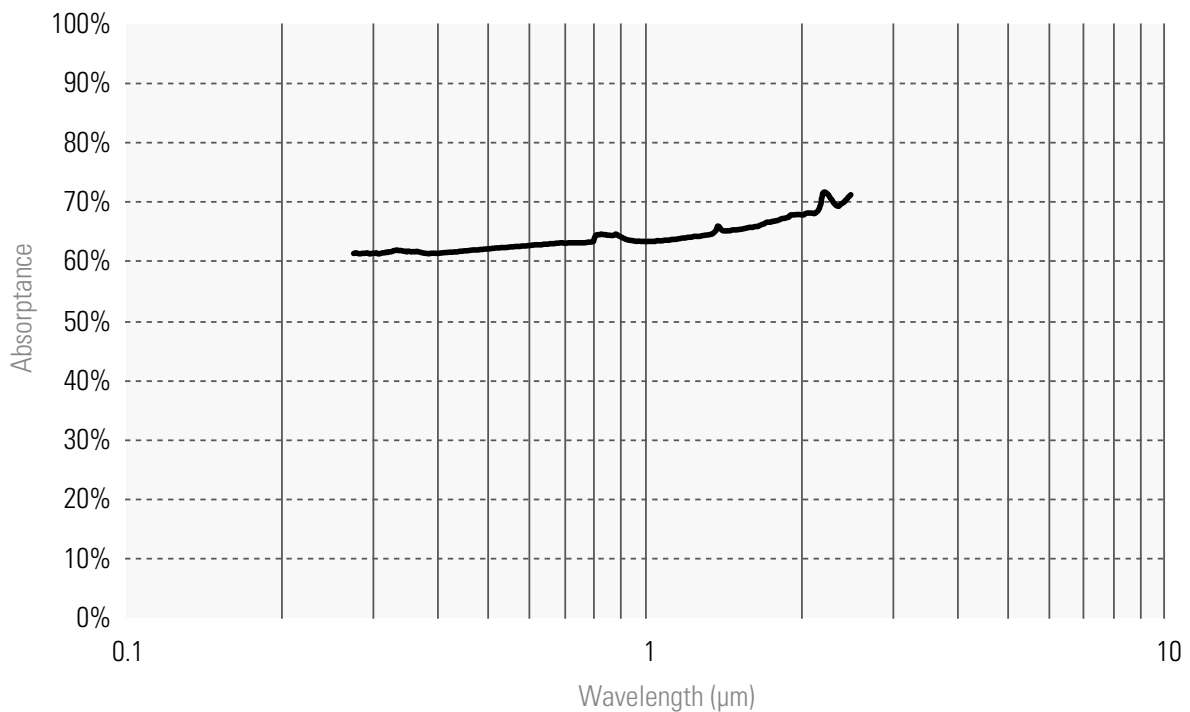

ABSORPTION CURVES

PH100-SI-HA sensitivity

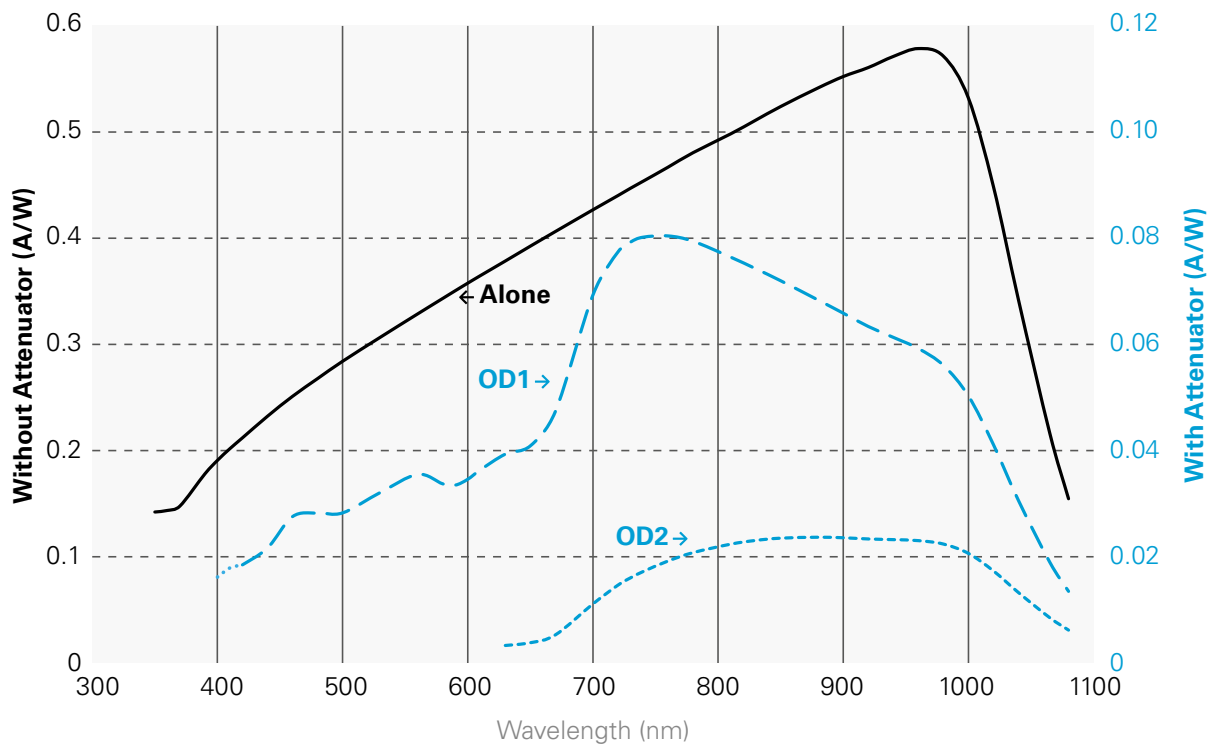

PH100-SI-HA maximum power

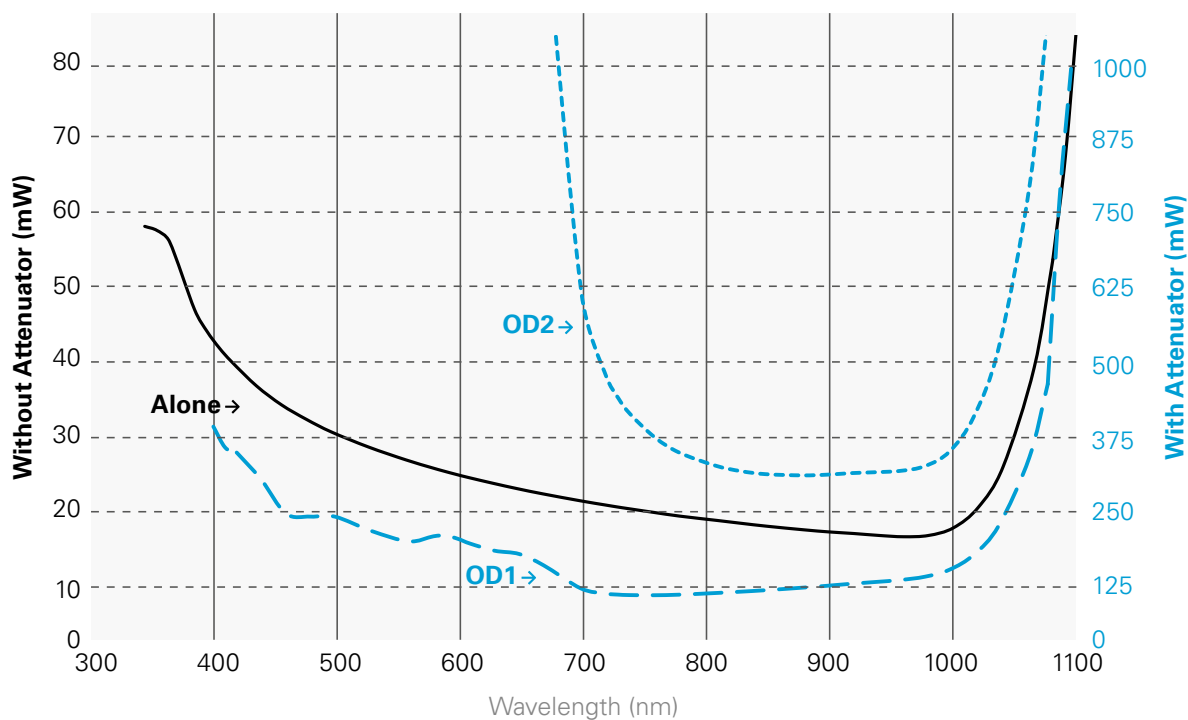

ABSORPTION CURVES

PH100-SIUV sensitivity

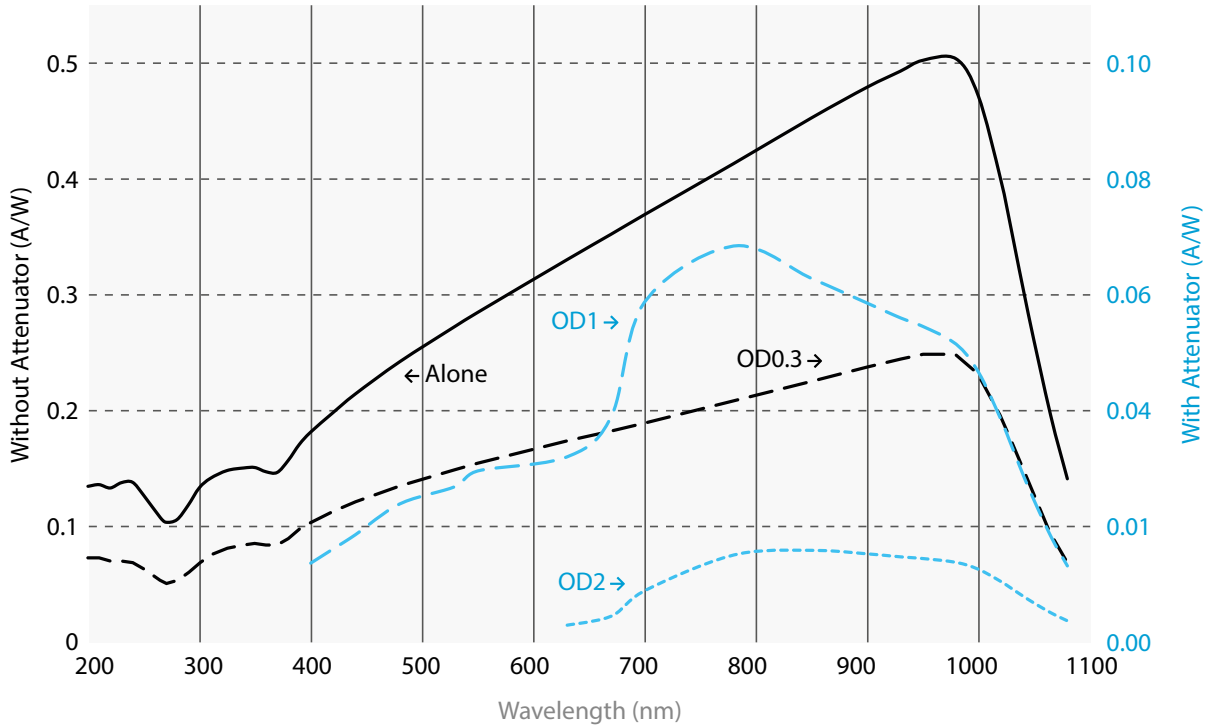

PH100-SIUV maximum power

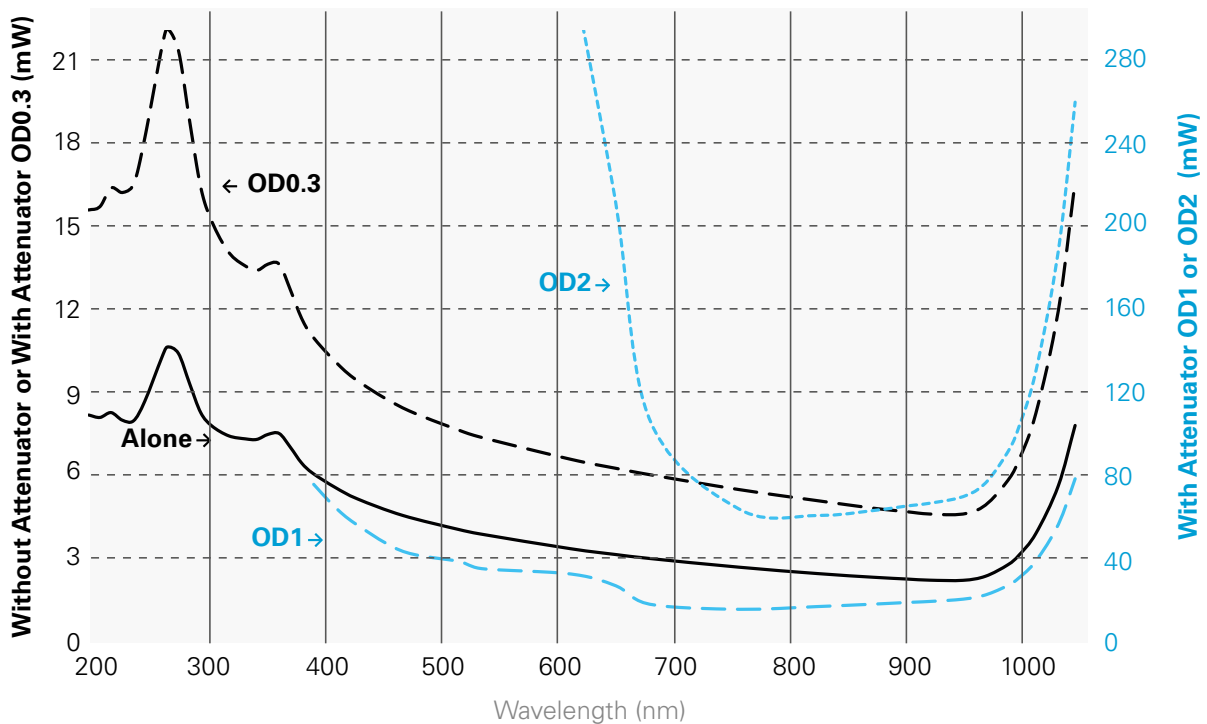

ABSORPTION CURVES

PH20-GE sensitivity

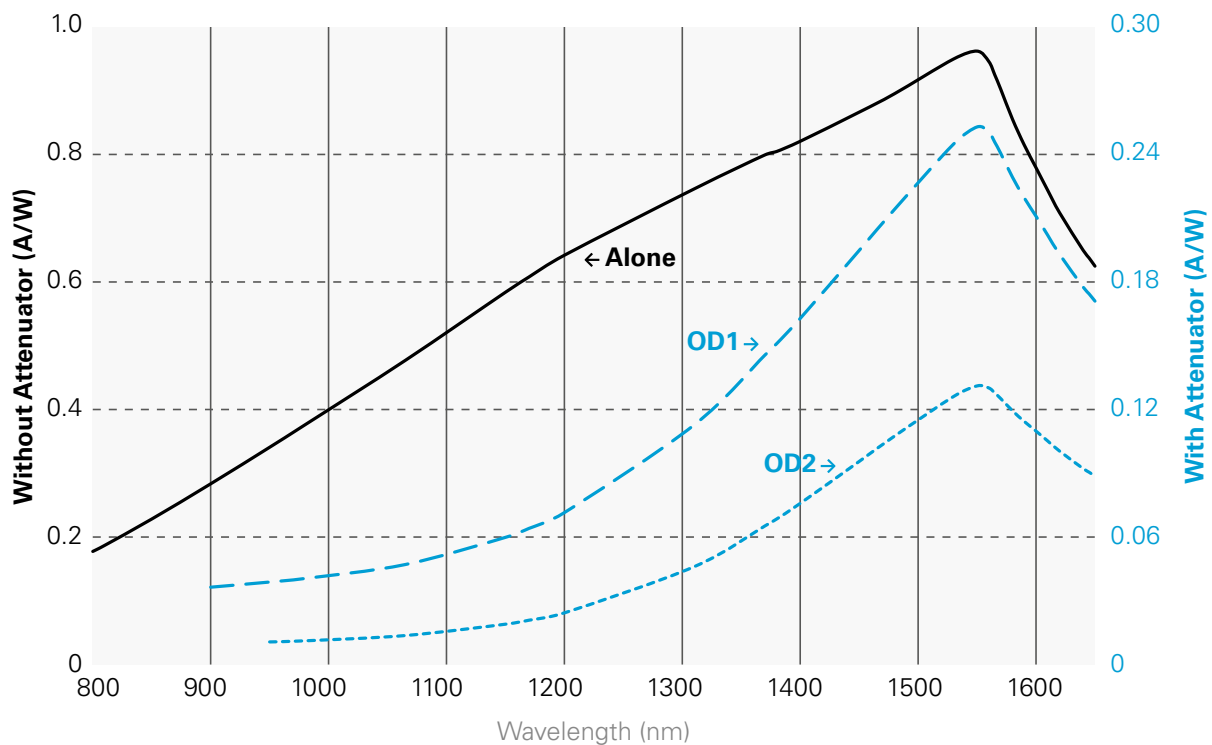

PH20-GE maximum power

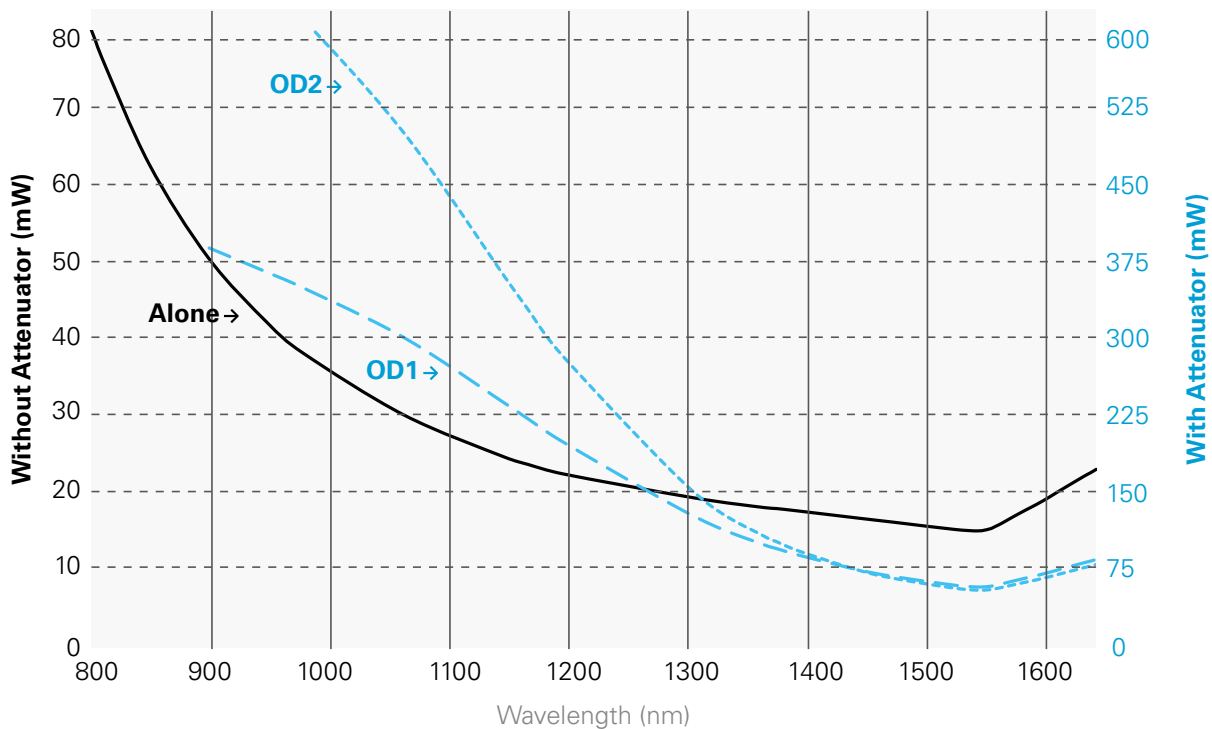

ABSORPTION CURVES

PRONTO-SI sensitivity

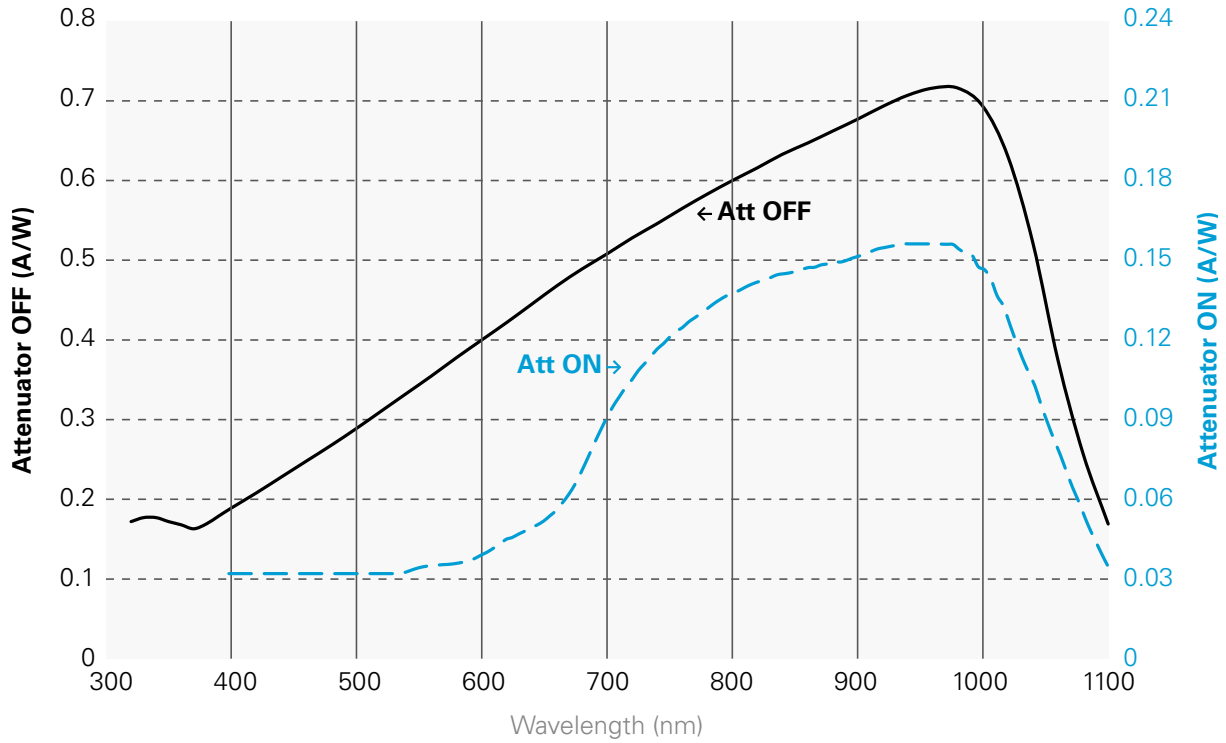

PRONTO-SI maximum power

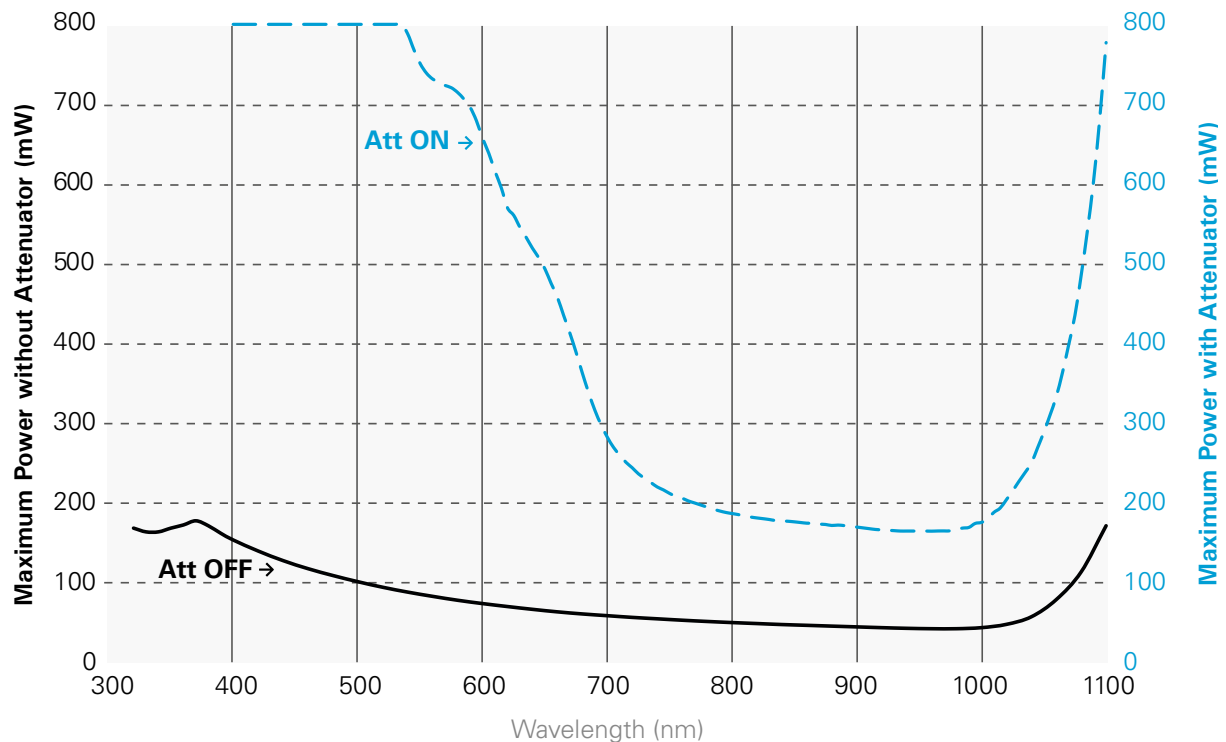

ENERGY DETECTOR

Low energy measurement

Available with

integra

PE: PHOTODETECTORS

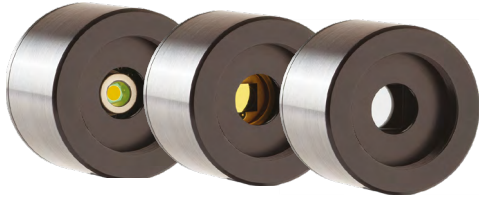

- Available in 3 sizes:
 - 3 mm \varnothing
 - 5 mm \varnothing
 - 10 mm \varnothing
- 3 choices of absorber for different wavelength ranges:
 - Silicon
 - Germanium
 - InGaAs
- Extremely low noise: as low as 8 fJ

■ LOWEST NOISE LEVEL OF ALL ENERGY DETECTORS

Available with

integra

QE-B: HIGH-SENSITIVITY PYROELECTRIC DETECTORS



Our pyroelectric energy detectors have very low noise levels combined with a large bandwidth. They have everything you need to accurately measure extremely low energy from the DUV to the FIR.

- 8 mm \varnothing aperture
- 2 choices of absorber:
 - MT: Fast response and high sensitivity
 - BL: Flat spectral response
- Broadband, from the DUV to the FIR
- Very low noise: as low as 50 nJ

■ MEASURE LOW ENERGY AT ANY WAVELENGTH

MACH 6: MEASURE ALL PULSES UP TO 200 KHZ



- High-speed digital joulemeter:
 - Measures EVERY PULSE at 200 kHz
- Capture and store up to 4 million pulses at the maximum repetition rate
- Track missing pulses and pulses below threshold
- Wide energy range: measure from pJ to mJ

■ 200 kHz ENERGY METER

ENERGY DETECTORS

General use energy detectors

New product

Available with
integra

QE-MB

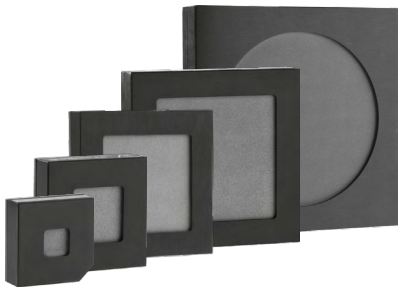

Pyroelectric energy meters cover a very wide range, going from nanojoules to several tens of joules per pulse. Our standard absorber offers high damage thresholds and a spectrally flat response, making this series of energy detectors a versatile solution that can cover most of your energy measurement needs.

- Broadband absorber with high damage thresholds
- Available in 5 sizes:
 - 12 x 12 mm 25 x 25 mm
 - 50 x 50 mm 65 x 65 mm
 - 95 mm Ø
- Available with 2 cooling modules:
 - Convection (S)
 - Heatsink (H)

■ THE WIDEST RANGE OF LASER ENERGY MEASUREMENT

New product

Available with
integra

QE-MT: HIGH REPETITION RATES



Designed for pulsed lasers with high repetition rates, these energy detectors feature an improved temporal response to accurately measure pulse-to-pulse energy at high repetition rates up to 10 kHz.

- Fast response, broadband absorber
- Available in 3 sizes:
 - 12 x 12 mm
 - 25 x 25 mm
 - 50 x 50 mm
- Available with 2 cooling modules:
 - Convection (S)
 - Heatsink (H)

■ UP TO 10 KHZ REPETITION RATE

ENERGY DETECTORS

QED attenuators

The QED attenuators increase the maximum energy, energy density, average power and average power density that the QE series detectors can handle. They are engineered to typically transmit 30-50% (at 1064 nm) of the incident radiation to the detector in a near Lambertian pattern (very wide diffusion pattern). Their slide-in casing make them easy to install and remove and they are held securely in place with the use of simple set screws. Since they become part of the detector, it is important to understand how they will affect the calibration.

CALIBRATION OPTIONS

Depending on how you plan to use a QE detector and QED attenuator, different purchasing and calibration options are available.

QE detector with QED attenuator included



Product name contains "-QED"

Ex: QE25LP-S-MB-QED-D0

This product is calibrated with the QED attenuator in place. You may remove the attenuator, but your measurements will not be calibrated with this configuration.

QE detector and QED attenuator purchased separately



OR



Product name does not contain "-QED"

Ex: QE25LP-S-MB-D0 and QED-25

Three calibration options are available when you purchase the QE detector and the QED attenuator separately.

FULL CALIBRATION

The detector is fully calibrated both with and without attenuator. This configuration comes with a DB15 adaptor.

• QED-CAL-3

PARTIAL CALIBRATION

The detector is fully calibrated without attenuator, and is calibrated at a single wavelength with the attenuator.

• QED-CAL-1

NO EXTRA CALIBRATION

The QE detector is fully calibrated without attenuator only. You may add the attenuator, but your measurements will not be calibrated with this configuration.

Detector alone	Fully calibrated	Fully calibrated	Fully calibrated
Detector with attenuator	Fully calibrated when using the DB15 adaptor	Calibrated at 1064 nm only	Not calibrated

SPECIFICATIONS

PHYSICAL CHARACTERISTICS	QED-12	QED-25	QED-50	QED-65	QED-95
Spectral range	266 - 2100 nm	266 - 2100 nm	266 - 2100 nm	266 - 2100 nm	266 - 2100 nm
Calibrated spectral range	532 - 2100 nm	308 - 2100 nm	308 - 2100 nm	308 - 2100 nm	308 - 2100 nm
Effective aperture	9 x 9 mm	22 x 22 mm	47 x 47 mm	62 x 62 mm	90 mm ϕ
Dimensions	30.5H x 41W x 12.5D mm	44H x 55W x 12.5D mm	69H x 80W x 12.5D mm	85H x 97W x 12.5D mm	115H x 127W x 12.5D mm
For use with	QE12	QE25	QE50	QE65	QE95

ENERGY DETECTORS

High energy detectors



PRONTO-500-IPL

- Compact energy meter for up to 350 J
- 55 mm Ø aperture
- Color touchscreen display
- Rugged device: all-metal body and protective window

■ IDEAL FOR IPL SOURCES: UP TO 350 J



CUSTOM CALORIMETERS

We work with a wide range of materials from surface coatings to the most robust volume absorbers to provide the best solution for your specific application.

- Outstanding signal-to-noise ratios
- High sensitivity
- Vacuum compatibility
- Attention to detail and workmanship

With over 50 years of experience in thermal-based energy measurement, Gentec-EO is the ideal choice for all your high energy measurement needs.

EXAMPLES OF CUSTOM CALORIMETERS

	SPECTRAL RANGE	MINIMUM ENERGY	MAXIMUM ENERGY*
RECTANGULAR APERTURES			
420 x 427 mm	1053 nm	500 J	16 000 J
420 x 427 mm	351/532/1053 nm	200 J	5000 J
110 x 110 mm	351/532/1053 nm	1 J	50 J
400 x 400 mm	351/532/1053 nm	200 J	5000 J
230 x 230 mm	532/1064 nm	100 J	1500 J
ROUND APERTURES			
310 mm Ø	351 nm	20 J	500 J
310 mm Ø	0.35 - 1.1 µm	200 J	1500 J
150 mm Ø	0.3 - 1.1 µm	1 J	500 J
50 mm Ø	0.19 - 10 µm	15 mJ	200 J
19 mm Ø	0.19 - 25 µm	1 mJ	2.3 J

* Maximum measurable energy depends on pulse width and wavelength.

PE

8 fJ - 150 nJ, our lowest energy measurements



KEY FEATURES

- > **VERY LOW NOISE LEVEL**
Take measurements with a noise level as low as 8 fJ (model PE3B-Si only) with the M-LINK, MAESTRO and S-LINK
- > **3 SENSORS AVAILABLE**
 - PE-B-SI family: 3 and 10 mm Ø silicon sensors for 0.21 to 1.08 µm
 - PE5B-GE: 5 mm Ø, germanium sensor for 0.8 to 1.65 µm
 - PE3B-IN: 3 mm Ø, InGaAs sensor for 0.9 to 1.7 µm

OUTPUT OPTIONS

- > **SMART INTERFACE**
Containing all the calibration data
- > **ANALOG OUTPUT**
When used with APM (D) analog power supply
- > **integra ALL-IN-ONE-METER**
Connects directly to a PC
Three models available:
 - USB output (-INT)
 - RS-232 output (-IDR)
 - USB with external trigger (-INE)

COMPATIBLE DISPLAYS & PC INTERFACES



MIRO ALTITUDE



MAESTRO



U-LINK



M-LINK



S-LINK

ACCESSORIES



Stand with delrin post



Fiber adaptors & connectors (FC, ST or SMA)



APM (D) analog power supply







Pelican carrying case



Isolation tube

This product cannot be used with DB15 extension cables



	PE3B-SI-D0	PE10B-SI-D0	PE5B-GE-D0	PE3B-IN-D0
MAX MEASURABLE ENERGY*	24 pJ	81 nJ	2.4 nJ	245 pJ
EFFECTIVE APERTURE	3 mm ϕ	10 mm ϕ	5 mm ϕ	3 mm ϕ
MEASUREMENT CAPABILITY				
Calibrated spectral range	210 - 1080 nm	210 - 1080 nm	800 - 1650 nm	900 - 1700 nm
Maximum measurable energy*				
With M-LINK	22 pJ at 634 nm	75 nJ at 634 nm	2.2 nJ at 1310 nm	223 pJ at 1310 nm
With S-LINK	24 pJ at 634 nm	81 nJ at 634 nm	2.4 nJ at 1310 nm	245 pJ at 1310 nm
With MAESTRO	20 pJ at 634 nm	69 nJ at 634 nm	2.0 nJ at 1310 nm	200 pJ at 1310 nm
With INTEGRA	24 pJ at 634 nm	81 nJ at 634 nm	2.4 nJ at 1310 nm	245 pJ at 1310 nm
Noise equivalent energy^a	8 fJ at 634 nm	1.5 pJ at 634 nm	1 pJ at 1310 nm	30 fJ at 1310 nm
Rise time (0-100%)	15 μ s	30 μ s	25 μ s	12 μ s
Max repetition rate	1000 Hz	1000 Hz	1000 Hz	1000 Hz
Max pulse width	10 μ s	10 μ s	10 μ s	10 μ s
Calibration uncertainty^b	$\pm 4\%$ ^c	$\pm 18\%$ (210 - 229 nm) $\pm 8.0\%$ (230 - 254 nm) $\pm 6.5\%$ (255 - 399 nm) $\pm 2.5\%$ (400 - 899 nm) $\pm 4.0\%$ (900 - 1009 nm) $\pm 7.5\%$ (1010 - 1080 nm)	$\pm 5\%$ (800 - 1049 nm) $\pm 3.5\%$ (1050 - 1559 nm) $\pm 7\%$ (1560 - 1629 nm) $\pm 10\%$ (1630 - 1650 nm)	$\pm 4\%$ ^d
DAMAGE THRESHOLDS				
Max energy density	N/A	5 μ J/cm ²	5 μ J/cm ²	N/A
Max average power density	N/A	65 mW/cm ² at 532 nm	320 mW/cm ² at 1064 nm	N/A
PHYSICAL CHARACTERISTICS				
Effective aperture	3 mm ϕ	10 mm ϕ	5 mm ϕ	3 mm ϕ
Distance to sensor face	13.7 mm	13.7 mm	10.5 mm	N/A
Sensor	UV-silicon	UV-silicon	Germanium	InGaAs
Dimensions	38.1 ϕ x 27.4D mm	38.1 ϕ x 27.4D mm	38.1 ϕ x 27.4D mm	38.1 ϕ x 27.4D mm
Weight	91 g	91 g	91 g	91 g
ORDERING INFORMATION				
Available output options	DB15, USB or RS-232	DB15, USB or RS-232	DB15, USB or RS-232	DB15, USB or RS-232
Compatible stand	STAND-D-233 or STAND-D-233-M	STAND-D-233 or STAND-D-233-M	STAND-D-233 or STAND-D-233-M	STAND-D-233 or STAND-D-233-M
Product page				

* See curves (p. 102-103) for maximum energy at other wavelengths

a. Nominal value. Depends on environmental electromagnetic interference and wavelength.

b. With Gentec-EO display or PC interface.

c. This detector is NIST Traceable at the calibration wavelength of 634 nm. Typical values are used at other wavelengths.

d. This detector is NIST Traceable at the calibration wavelength of 1310 nm. Typical values are used at other wavelengths.

QE-B

50 nJ - 3.6 mJ, ultra-low energy measurements



KEY FEATURES

- > **VERY LOW NOISE LEVELS**
Noise levels of a photodetector, but with the high energies of a pyroelectric:
 - 50 nJ with the MT coating
 - 100 nJ with the BL coating
- > **2 COATINGS AVAILABLE**
 - BL: Black coating, sensitivity of 900 V/J, readings up to 400 Hz
 - MT: Metallic coating, sensitivity of 2400 V/J, readings up to 1000 Hz

OUTPUT OPTIONS

- > **SMART INTERFACE**
Containing all the calibration data
- > **ANALOG OUTPUT**
When used with APM (D) analog power supply
- > **integra ALL-IN-ONE-METER**
Connects directly to a PC
Three models available:
 - USB output (-INT)
 - RS-232 output (-IDR)
 - USB with external trigger (-INE)

COMPATIBLE DISPLAYS & PC INTERFACES



MIRO ALTITUDE



MAESTRO



U-LINK



M-LINK



S-LINK

ACCESSORIES



Stand with delrin post



Fiber adaptors & connectors
(FC, ST or SMA)



APM (D) analog power supply





Pelican carrying case



Isolation tube

This product cannot be used with DB15 extension cables



	QE8SP-B-BL	QE8SP-B-MT
MAX MEASURABLE ENERGY	3.6 mJ	1.3 mJ
MAX REPETITION FREQUENCY	400 Hz	1000 Hz
EFFECTIVE APERTURE	7.8 X 7.8 mm	7.8 X 7.8 mm
MEASUREMENT CAPABILITY		
Spectral range	0.19 - 20 μm	0.19 - 20 μm
Calibrated spectral range ^a	0.248 - 2.1 μm	0.248 - 2.1 μm
Max measurable energy		
With U-LINK	3.6 mJ	1.3 mJ
With S-LINK	2.9 mJ	1.1 mJ
With MAESTRO	2.5 mJ	0.93 mJ
Noise equivalent energy		
With U-LINK	150 nJ	80 nJ
With S-LINK	100 nJ	50 nJ
With MAESTRO	150 nJ	80 nJ
Max repetition frequency	400 Hz	1000 Hz
Max pulse width	10 μs	10 μs
Risetime (0-100%)	30 μs	30 μs
Calibration uncertainty	$\pm 4.0\%$	$\pm 4.0\%$
Repeatability	< 0.5%	< 0.5%
DAMAGE THRESHOLDS		
Maximum average power	0.5 W	0.5 W
Maximum average power density		
1064 nm, 7 ns, 10 Hz	1 W/cm ²	1 W/cm ²
Maximum energy density		
1064 nm, 7 ns, 10 Hz	50 mJ/cm ²	50 mJ/cm ²
PHYSICAL CHARACTERISTICS		
Effective aperture	7.8 x 7.8 mm	7.8 x 7.8 mm
Absorber	Organic black	Metallic
Dimensions	38.1 \varnothing X 27.4D mm	38.1 \varnothing X 27.4D mm
Weight	91 g	91 g
ORDERING INFORMATION		
Available output options	DB15, USB or RS-232	DB15, USB or RS-232
Compatible stand	STAND-D-233 or STAND-D-233-M	STAND-D-233 or STAND-D-233-M
Product page		

a. Calibration at 2.1 to 2.5 μm is available on special request.

MACH 6

200 kHz energy meter



KEY FEATURES

- **UP TO 200 kHz PULSE-TO-PULSE**
Measure EVERY pulse, with no sampling, at high rep rates, up to 200 kHz
- **CAPTURE AND STORE UP TO 4 MILLION PULSES**
Store 40 seconds of data at 100 kHz
- **TRACK MISSING PULSES AND PULSES BELOW THRESHOLD**
Know how many pulses were missed or that didn't make the energy threshold with this unique pulse feature
- **SEVERAL HEADS TO CHOOSE FROM**
Silicon, InGaAs and pyroelectric heads for a broad wavelength and energy range
- **ANALOG MODULE AVAILABLE**
Use our fast M6 detectors with the APM and an oscilloscope for fast analog energy measurements
- **FULL-SPEED USB 2.0 CONNECTION**
Ensures high data rate transfer and fast operation
- **USER-FRIENDLY SOFTWARE WITH MANY DIAGNOSTIC FEATURES**
 - Live mode, strip chart, histogram and statistics displays
 - FFT display of pulse energy data for temporal diagnostics
 - Life test mode to automate laser testing

COMPATIBLE DISPLAYS & PC INTERFACES



MACH 6



APM

ACCESSORIES



Stand with delrin post



Additional 9V power supply



USB cable



APM analog power supply
(requires adaptor when used
with M6 heads)



M6-UV-QED
Relative measurements in UV









Pelican carrying case

MACH 6

Specifications



	M6-6-SI	M6-6-SI-L	M6-6-IN	M6-6-IN-L	M6-6-PY	M6-12.5-PY
MAX ENERGY^a	200 µJ	2 µJ	200 µJ	2 µJ	2 mJ	20 mJ
MAX AVERAGE POWER	5 W	5 W	5 W	5 W	5 W	25 W
MAX REP RATE	200 000 Hz	200 000 Hz	200 000 Hz	200 000 Hz	200 000 Hz	200 000 Hz
EFFECTIVE APERTURE	6 mm Ø	6 mm Ø	6 mm Ø	6 mm Ø	6 mm Ø	12.5 mm Ø
MEASUREMENT CAPABILITY						
Spectral range	0.35 - 1.1 µm	0.35 - 1.1 µm	0.9 - 1.6 µm	0.9 - 1.6 µm	0.35 - 2.5 µm	0.35 - 2.5 µm
Max measurable energy^a	200 µJ	2 µJ	200 µJ	2 µJ	2 mJ	20 mJ
Noise equivalent energy	2 nJ	20 pJ	2 nJ	20 pJ	0.2 µJ	0.2 µJ
Rise time (0-100%)	150 ns	150 ns	150 ns	150 ns	150 ns	150 ns
Max repetition rate	200 000 Hz	200 000 Hz	200 000 Hz	200 000 Hz	200 000 Hz	200 000 Hz
Max pulse width	100 ns	100 ns	100 ns	100 ns	100 ns	100 ns
Calibration uncertainty	± 4%	± 4%	± 4%	± 4%	± 4%	± 4%
Repeatability	± 1%	± 1%	± 1%	± 1%	± 1%	± 1%
DAMAGE THRESHOLDS						
Max average power (60 seconds)	5 W	5 W	5 W	5 W	5 W	25 W
Max energy (at 1064 nm)	200 µJ	2 µJ	200 µJ	2 µJ	20 mJ	20 mJ
PHYSICAL CHARACTERISTICS						
Effective aperture	6 mm Ø	6 mm Ø	6 mm Ø	6 mm Ø	6 mm Ø	12.5 mm Ø
Sensor	Silicon	Silicon	InGaAs	InGaAs	Pyroelectric	Pyroelectric
Dimensions	38.1 Ø x 58.4D mm	38.1 Ø x 58.4D mm	38.1 Ø x 58.4D mm	38.1 Ø x 58.4D mm	38.1 Ø x 58.4D mm	76H x 111W x 76D
Weight (head only)	150 g	150 g	150 g	150 g	150 g	N/A
COMPATIBLE METERS						
PC-based	Mach 6: see detailed specifications on next page					
Analog power supply	APM: see detailed specifications on next page (requires adaptor when used with M6 heads)					
ORDERING INFORMATION						
Compatible stand	STAND-D-233	STAND-D-233	STAND-D-233	STAND-D-233	STAND-D-233	STAND-D-233
Product page						

a. Maximum pulse energy reading will vary with wavelength and probe voltage responsivity (Rv). For more details, please read Application Note 121D-201932 and contact us at info@gentec-eo.com

MACH 6

Specifications



MACH 6 JOULEMETER

Measure every pulse at up to 200 kHz with MACH 6. Measure with 12-bit digital accuracy and capture up to 4 million pulses in real time. Our MACH 6 joulemeter is the only instrument in the world that performs at this speed, and with this precision. It is designed to support our full complement of fast energy probes that include silicon, InGaAs and pyroelectric detectors. Measure from pJ to mJ and from 0.35 to 2.5 μm . Using the M6-Si detector and the M6-UV-QED accessory, you can make relative measurements at 266 nm.

MACH 6
(rear view)



APM analog
power supply
(front view)



SPECIFICATIONS & FEATURES

	MACH 6	APM
Compatible detector heads	M6	M6 (with adaptor: P/N C201949), UM-B, QE8, THZ9D and PE detectors
Maximum repetition rate	200 000 Hz	Limited by oscilloscope and detector
Analog output	0 - 3 V	± 4.88 V, BNC
External trigger (TTL)	Optically coupled	None
Internal trigger	2 - 20%	None
Trigger delay	38 - 3825 ns (user-settable)	None
Digital output	USB 2.0	None
Power supply	External, 100/240 VAC 50 - 60 Hz	External, 100/240 VAC 50 - 60 Hz, and 9 V battery (both included)
Product number	202090	201848

INSTRUMENT CONTROL SCREEN

Our powerful LabVIEW application software includes many unique control and diagnostic features. The instrument control screen, shown on the left, is used to set up the operation of the MACH 6, including range, trigger, wavelength, and more. In addition, it is used to set a pulse batch size and to arm the instrument, which starts the data collection. It also gives you access to features like "Autoset", "Call Live Mode", "Run Life Test", "Save Instrument Setup" and the like. These features can be accessed by clicking directly on the feature or pushing the associated function key.

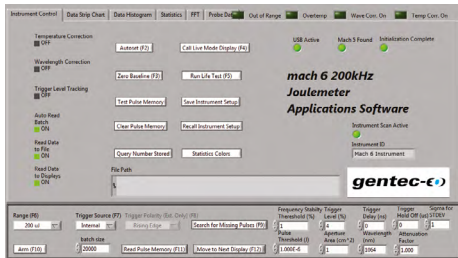

LIVE MODE DISPLAY

The live mode can be accessed from the instrument control screen, or by simply pressing the "F4" function key on your PC. This mode of operation is intended to act like your typical slower digital joulemeter, as it samples the laser pulses at a 10 Hz rate. It provides you with an energy strip chart, live energy reading, statistics and repetition rate. It is a very useful mode when setting up the Mach 6 with your laser. You can select "Auto Set", where the instrument runs through the ranges and trigger levels until it finds the correct range, or set them manually. When setup is complete, you will exit this screen and return to the "Control" screen where you will select a batch size, arm the instrument and start taking pulse energy data.

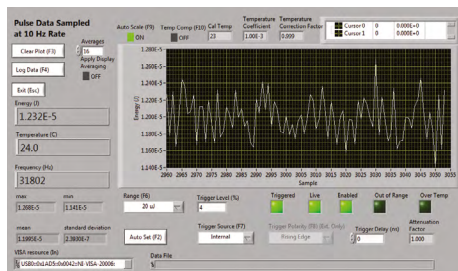

STRIP CHART

The strip chart display provides a quick graphical look at the pulse data batch just collected. The data can be displayed in full scale or in auto scale mode. You can also zoom-in on a portion of the data, like shown in the screen on the left. An ND0.3 filter has been dropped through the beam and you can see the effects on the pulse data collected. You can fit trend and min/max lines to the data. Just below the chart, you will find a complete set of statistics for the batch. At the top of this screen you will see tabs that will take you to the Histogram, Statistics, and FFT (Fast Fourier Transform) displays.

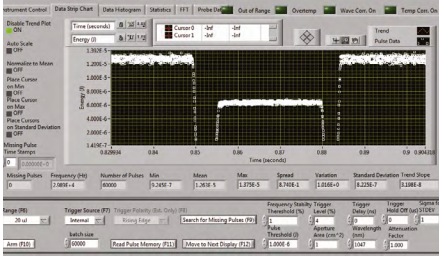

HISTOGRAM

Interested in viewing the statistical distribution of the pulse energy data set? The Histogram screen does this for you and fits a "best Gaussian curve" to the data. It displays complete statistical calculations along the bottom of the graph, along with pulse frequency. Just below the statistics, you will find instrument controls, like range and trigger. You are also given the ability to adjust trigger delay and hold off as needed.

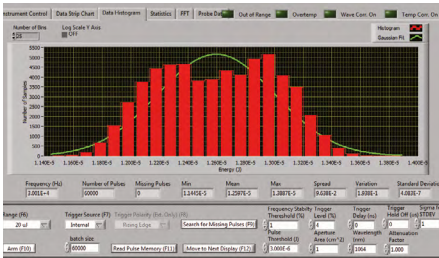

STATISTICS

The statistics display offers a very complete set of useful energy readings and calculated statistics. These include: minimum, maximum, average (mean), standard deviation, spread and variation. Some other very handy features include: windows displaying, average frequency, pulse jitter, pulses below trigger and pulses below threshold (a level set by you). In the screen on the left, you can see that there were 12 pulses below an energy threshold of 3 μW, and 147 missing pulses (or pulses below trigger).

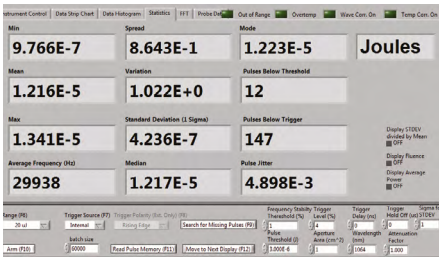

LIFE TEST MODE

Would you like to run a life test on your high repetition rate pulsed laser? How about a periodic test vs. an environmental change like temperature? We have included a great feature to accomplish this. In the life test screen, we give you the ability to select the statistics you want, a start time and date, a stop time and date, the number of pulses and a test interval. You simply identify a file, a place to put the data, and then click on start and walk away! When you come back, you have a data set that tracked the performance of your laser over time, temperature, shock, vibration or anything you chose.

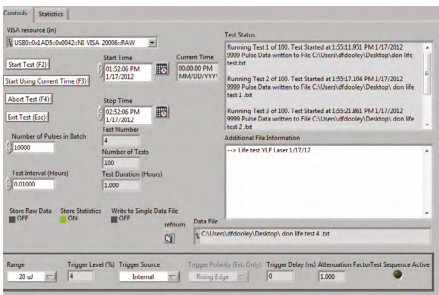

QE12-MB

12 x 12 mm, 0.7 μ J - 3.9 J

New product



KEY FEATURES

- > **MODULAR CONCEPT**
Increase the power capability of your detector:
2 different cooling modules
- > **LOW NOISE LEVEL**
- > **QED ATTENUATOR AVAILABLE**
 - Measure up to 5X higher energies
 - Available with optional calibration, all wavelengths between 532 & 1064 nm, or single wavelength
- > **HIGH REPETITION RATE OPTIONS**
 - QE12LP: 300 Hz
 - QE12HR: 1000 Hz
- > **TEST TARGET INCLUDED**

OUTPUT OPTIONS

- > **SMART INTERFACE**
Containing all the calibration data
- > **integra ALL-IN-ONE-METER**
Connects directly to a PC
Three models available:
 - USB output (-INT)
 - RS-232 output (-IDR)
 - USB with external trigger (-INE)

COMPATIBLE DISPLAYS & PC INTERFACES



MIRO ALTITUDE



MAESTRO



U-LINK



M-LINK



S-LINK

ACCESSORIES



Stand with delrin post



DB15 to BNC adaptor









QED-12 attenuator



Pelican carrying case



	QE12LP-S-MB	QE12LP-S-MB-QED	QE12LP-H-MB	QE12LP-H-MB-QED	QE12HR-H-MB	QE12HR-H-MB-QED
MAX MEASURABLE ENERGY^a	3.9 J	3.9 J	3.9 J	3.9 J	0.85 J	3.9 J
MAX REPETITION FREQUENCY^b	300 Hz	300 Hz	300 Hz	300 Hz	1 kHz	1 kHz
EFFECTIVE APERTURE	12 x 12 mm	9 x 9 mm	12 x 12 mm	9 x 9 mm	12 x 12 mm	9 x 9 mm
MEASUREMENT CAPABILITY						
Spectral range	0.19 - 20 μm	0.3 - 2.1 μm	0.19 - 20 μm	0.3 - 2.1 μm	0.19 - 20 μm	0.3 - 2.1 μm
Calibrated spectral range^c	0.248 - 2.1 μm	0.532 - 2.1 μm	0.248 - 2.1 μm	0.532 - 2.1 μm	0.248 - 2.1 μm	0.532 - 2.1 μm
Maximum measurable energy^a						
1064 nm, 7 ns	0.85 J	3.9 J	0.85 J	3.9 J	0.85 J	3.9 J
266 nm, 7 ns	0.70 J	0.81 J	0.70 J	0.81 J	0.70 J	0.81 J
Noise equivalent energy^d	0.7 μJ	1.4 μJ	0.7 μJ	1.4 μJ	1.4 μJ	2.8 μJ
Max repetition frequency^b	300 Hz	300 Hz	300 Hz	300 Hz	1 kHz	1 kHz
Maximum pulse width (typical)^e	400 μs	400 μs	400 μs	400 μs	40 μs	40 μs
Rise time (typical 0-100%)	550 μs	550 μs	550 μs	550 μs	70 μs	70 μs
Calibration uncertainty^f	$\pm 3\%$	$\pm 3\%$	$\pm 3\%$	$\pm 3\%$	$\pm 3\%$	$\pm 3\%$
Repeatability	< 0.5%	< 0.5%	< 0.5%	< 0.5%	< 0.5%	< 0.5%
DAMAGE THRESHOLDS						
Maximum average power	3 W	7.5 W	5 W	12.5 W	5 W	12.5 W
Maximum energy density						
1064 nm, 7 ns, single shot	0.6 J/cm ²	16 J/cm ²	0.6 J/cm ²	16 J/cm ²	0.6 J/cm ²	16 J/cm ²
1064 nm, 7 ns, 10 Hz	0.6 J/cm ²	8 J/cm ²	0.6 J/cm ²	8 J/cm ²	0.6 J/cm ²	8 J/cm ²
532 nm, 7 ns, 10 Hz	0.6 J/cm ²	6 J/cm ²	0.6 J/cm ²	6 J/cm ²	0.6 J/cm ²	6 J/cm ²
266 nm, 7 ns, 10 Hz	0.5 J/cm ²	1 J/cm ²	0.5 J/cm ²	1 J/cm ²	0.5 J/cm ²	1 J/cm ²
Maximum average power density^g	10 W/cm ²	600 W/cm ²	10 W/cm ² ^j	600 W/cm ²	10 W/cm ²	600 W/cm ²
PHYSICAL CHARACTERISTICS						
Effective aperture (with attenuator)	12 x 12 mm	9 x 9 mm	12 x 12 mm	9 x 9 mm	12 x 12 mm	9 x 9 mm
Absorber	MB	QED	MB	QED	MB	QED
Dimensions	36H x 36W x 14D mm	39H x 41W x 19D mm	36H x 36W x 33D mm	39H x 41W x 38D mm	36H x 36W x 33D mm	39H x 41W x 38D mm
Weight	87 g	87 g	117 g	117 g	117 g	117 g
ORDERING INFORMATION						
Available output options	DB15, USB or RS-232	DB15, USB or RS-232	DB15, USB or RS-232	DB15, USB or RS-232	DB15, USB or RS-232	DB15, USB or RS-232
Compatible stand	STAND-D-233	STAND-D-233	STAND-D-233	STAND-D-233	STAND-D-233	STAND-D-233
Product page						

a. Not exceeding maximum average power. Increasing pulse width increases the maximum measurable energy.
 b. With the IDR version, measured values are sampled when the repetition rate is > 200 Hz.
 c. Calibration at 2.1 to 2.5 μm is available on special request.
 d. Nominal value, actual value depends on electrical noise in the measurement system.
 e. Also available on special order: ELP (extra-long pulse) version.
 f. Excludes non-linearities.
 g. At maximum power.

QE25-MB

25 x 25 mm, 2 μ J - 23 J

New product



KEY FEATURES

- > **MODULAR CONCEPT**
Increase the power capability of your detector:
2 different cooling modules
- > **LOW NOISE LEVEL**
- > **QED ATTENUATOR AVAILABLE**
 - Measure up to 5X higher energies
 - Available with optional calibration, all wavelengths between 532 & 1064 nm, or single wavelength
- > **HIGH REPETITION RATE OPTIONS**
 - QE25LP: 300 Hz
 - QE25HR: 1000 Hz
- > **TEST TARGET INCLUDED**

OUTPUT OPTIONS

- > **SMART INTERFACE**
Containing all the calibration data
- > **integra ALL-IN-ONE-METER**
Connects directly to a PC
Three models available:
 - USB output (-INT)
 - RS-232 output (-IDR)
 - USB with external trigger (-INE)

COMPATIBLE DISPLAYS & PC INTERFACES



MIRO ALTITUDE



MAESTRO



U-LINK



M-LINK



S-LINK

ACCESSORIES



Stand with delrin post



DB15 to BNC adaptor



QED-25 attenuator









Pelican carrying case

QE25-MB

Specifications



	QE25LP-S-MB	QE25LP-S-MB-QED	QE25LP-H-MB	QE25LP-H-MB-QED	QE25HR-H-MB	QE25HR-H-MB-QED
MAX MEASURABLE ENERGY^a	3.8 J	23 J	3.8 J	23 J	3.8 J	23 J
MAX REPETITION FREQUENCY^b	300 Hz	300 Hz	300 Hz	300 Hz	1 kHz	1 kHz
EFFECTIVE APERTURE	25 x 25 mm	22 x 22 mm	25 x 25 mm	22 x 22 mm	25 x 25 mm	22 x 22 mm
MEASUREMENT CAPABILITY						
Spectral range	0.19 - 20 μm	0.3 - 2.1 μm	0.19 - 20 μm	0.3 - 2.1 μm	0.19 - 20 μm	0.3 - 2.1 μm
Calibrated spectral range^c	0.248 - 2.1 μm	0.308 - 2.1 μm	0.248 - 2.1 μm	0.308 - 2.1 μm	0.248 - 2.1 μm	0.308 - 2.1 μm
Maximum measurable energy^a						
1064 nm, 7 ns	3.8 J	23 J	3.8 J	23 J	3.8 J	23 J
266 nm, 7 ns	3.1 J	4.8 J	3.1 J	4.8 J	3.1 J	4.8 J
Noise equivalent energy^d	4 μJ	8 μJ	4 μJ	8 μJ	10 μJ	20 μJ
Max repetition frequency^b	300 Hz	300 Hz	300 Hz	300 Hz	1 kHz	1 kHz
Maximum pulse width (typical)^e	400 μs	400 μs	400 μs	400 μs	40 μs	40 μs
Rise time (typical 0-100%)	550 μs	550 μs	550 μs	550 μs	70 μs	70 μs
Calibration uncertainty^f	$\pm 3\%$	$\pm 3\%$	$\pm 3\%$	$\pm 3\%$	$\pm 3\%$	$\pm 3\%$
Repeatability	< 0.5%	< 0.5%	< 0.5%	< 0.5%	< 0.5%	< 0.5%
DAMAGE THRESHOLDS						
Maximum average power	5 W	15 W	10 W	30 W	10 W	30 W
Maximum energy density						
1064 nm, 7 ns, single shot	0.6 J/cm ²	16 J/cm ²	0.6 J/cm ²	16 J/cm ²	0.6 J/cm ²	16 J/cm ²
1064 nm, 7 ns, 10 Hz	0.6 J/cm ²	8 J/cm ²	0.6 J/cm ²	8 J/cm ²	0.6 J/cm ²	8 J/cm ²
532 nm, 7 ns, 10 Hz	0.6 J/cm ²	6 J/cm ²	0.6 J/cm ²	6 J/cm ²	0.6 J/cm ²	6 J/cm ²
266 nm, 7 ns, 10 Hz	0.5 J/cm ²	1 J/cm ²	0.5 J/cm ²	1 J/cm ²	0.5 J/cm ²	1 J/cm ²
Maximum average power density^g	10 W/cm ²	600 W/cm ²	10 W/cm ²	600 W/cm ²	10 W/cm ²	600 W/cm ²
PHYSICAL CHARACTERISTICS						
Effective aperture	25 X 25 mm	22 X 22 mm	25 X 25 mm	22 X 22 mm	25 X 25 mm	22 X 22 mm
Absorber	MB	QED	MB	QED	MB	QED
Dimensions	50H x 50W x 14D mm	53H x 55W x 19D mm	50H x 50W x 53D mm	53H x 55W x 58D mm	50H x 50W x 53D mm	53H x 55W x 58D mm
Weight	120 g	120 g	193 g	193 g	193 g	193 g
ORDERING INFORMATION						
Available output options	DB15, USB or RS-232	DB15, USB or RS-232	DB15, USB or RS-232	DB15, USB or RS-232	DB15, USB or RS-232	DB15, USB or RS-232
Compatible stand	STAND-D-233	STAND-D-233	STAND-D-233	STAND-D-233	STAND-D-233	STAND-D-233
Product page						

- a. Not exceeding maximum average power. Increasing pulse width increases the maximum measurable energy.
- b. With the IDR version, measured values are sampled when the repetition rate is > 200 Hz.
- c. Calibration at 2.1 to 2.5 μm is available on special request.
- d. Nominal value, actual value depends on electrical noise in the measurement system.
- e. Also available on special order: ELP (extra-long pulse) version
- f. Excludes non-linearities.
- g. At maximum power.

QE50-MB

50 x 50 mm, 10 μ J - 85 J



KEY FEATURES

- > **MODULAR CONCEPT**
Increase the power capability of your detector:
2 different cooling modules
- > **LOW NOISE LEVEL**
- > **QED ATTENUATOR AVAILABLE**
 - Measure up to 5X higher energies
 - Available with optional calibration,
all wavelengths between 532 & 1064 nm,
or single wavelength
- > **TEST TARGET INCLUDED**

OUTPUT OPTIONS

- > **SMART INTERFACE**
Containing all the calibration data
- > **integra ALL-IN-ONE-METER**
Connects directly to a PC
Three models available:
 - USB output (-INT)
 - RS-232 output (-IDR)
 - USB with external trigger (-INE)

COMPATIBLE DISPLAYS & PC INTERFACES



MIRO ALTITUDE



MAESTRO



U-LINK



M-LINK



S-LINK

ACCESSORIES



Stand with delrin post



DB15 to BNC adaptor

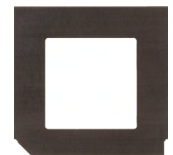





QED-50 attenuator



Pelican carrying case



	QE50LP-S-MB	QE50LP-S-MB-QED	QE50LP-H-MB	QE50LP-H-MB-QED
MAX MEASURABLE ENERGY ^a	15 J	85 J	15 J	85 J
MAX REPETITION FREQUENCY	200 Hz	200 Hz	200 Hz	200 Hz
EFFECTIVE APERTURE	50 x 50 mm	47 x 47 mm	50 x 50 mm	47 x 47 mm
MEASUREMENT CAPABILITY				
Spectral range	0.19 - 20 μm	0.3 - 2.1 μm	0.19 - 20 μm	0.3 - 2.1 μm
Calibrated spectral range ^b	0.248 - 2.1 μm	0.308 - 2.1 μm	0.248 - 2.1 μm	0.308 - 2.1 μm
Maximum measurable energy ^a				
1064 nm, 7 ns	15 J	85 J	15 J	85 J
266 nm, 7 ns	12.5 J	22 J	12.5 J	22 J
Noise equivalent energy ^c	10 μJ	20 μJ	10 μJ	20 μJ
Max repetition frequency	200 Hz	200 Hz	200 Hz	200 Hz
Maximum pulse width (typical) ^d	675 μs	675 μs	675 μs	675 μs
Rise time (typical 0-100%)	900 μs	900 μs	900 μs	900 μs
Calibration uncertainty ^e	$\pm 3\%$	$\pm 3\%$	$\pm 3\%$	$\pm 3\%$
Repeatability	< 0.5%	< 0.5%	< 0.5%	< 0.5%
DAMAGE THRESHOLDS				
Maximum average power	10 W	25 W	20 W	45 W
Maximum energy density				
1064 nm, 7 ns, single shot	0.6 J/cm ²	16 J/cm ²	0.6 J/cm ²	16 J/cm ²
1064 nm, 7 ns, 10 Hz	0.6 J/cm ²	8 J/cm ²	0.6 J/cm ²	8 J/cm ²
532 nm, 7 ns, 10 Hz	0.6 J/cm ²	6 J/cm ²	0.6 J/cm ²	6 J/cm ²
266 nm, 7 ns, 10 Hz	0.5 J/cm ²	1 J/cm ²	0.5 J/cm ²	1 J/cm ²
Maximum average power density ^f	10 W/cm ²	600 W/cm ²	10 W/cm ²	600 W/cm ²
PHYSICAL CHARACTERISTICS				
Effective aperture	50 x 50 mm	47 x 47 mm	50 x 50 mm	47 x 47 mm
Absorber	MB	QED	MB	QED
Dimensions	75H x 75W x 15D mm	78H x 80W x 20D mm	75H x 75W x 44D mm	78H x 80W x 49D mm
Weight	209 g	209 g	338 g	338 g
ORDERING INFORMATION				
Available output options	DB15, USB or RS-232	DB15, USB or RS-232	DB15, USB or RS-232	DB15, USB or RS-232
Compatible stand	STAND-D-233	STAND-D-233	STAND-D-233	STAND-D-233
Product page				

a. Not exceeding maximum average power. Increasing pulse width increases the maximum measurable energy.
 b. Calibration at 2.1 to 2.5 μm is available on special request.
 c. Nominal value, actual value depends on electrical noise in the measurement system.
 d. Also available on special order: ELP (extra-long pulse) version.
 e. Excludes non-linearities.
 f. At maximum power.

QE65-MB

65 x 65 mm, 10 μ J - 200 J



KEY FEATURES

- > **MODULAR CONCEPT**
Increase the power capability of your detector:
2 different cooling modules
- > **LARGE APERTURE**
Effective aperture of 65 x 65 mm
- > **QED ATTENUATOR AVAILABLE**
 - Measure up to 5X higher energies
 - Available with optional calibration,
all wavelengths between 532 & 1064 nm,
or single wavelength
- > **LOW NOISE LEVEL**
10 μ J for the MB coating
- > **TEST TARGET INCLUDED**
With the MB models

OUTPUT OPTIONS

- > **SMART INTERFACE**
Containing all the calibration data
- > **integra ALL-IN-ONE-METER**
Connects directly to a PC
Three models available:
 - USB output (-INT)
 - RS-232 output (-IDR)
 - USB with external trigger (-INE)

COMPATIBLE DISPLAYS & PC INTERFACES



MIRO ALTITUDE



MAESTRO



U-LINK



M-LINK



S-LINK

ACCESSORIES



Stand with delrin post
(200428, For -S model)



Stand with delrin post
(201284, For -H model)



DB15 to BNC adaptor



QED-65 attenuator







Pelican carrying case

QE65-MB

Specifications



	QE65LP-S-MB	QE65LP-S-MB-QED	QE65LP-H-MB	QE65LP-H-MB-QED	QE65ELP-H-MB
MAX MEASURABLE ENERGY ^a	25 J	200 J	25 J	200 J	50 J
MAX REPETITION FREQUENCY	100 Hz	100 Hz	100 Hz	100 Hz	20 Hz
EFFECTIVE APERTURE	65 x 65 mm	62 x 62 mm	65 x 65 mm	62 x 62 mm	65 x 65 mm
MEASUREMENT CAPABILITY					
Spectral range	0.19 - 20 μm	0.3 - 2.1 μm	0.19 - 20 μm	0.3 - 2.1 μm	0.19 - 20 μm
Calibrated spectral range ^b	0.248 - 2.1 μm	0.308 - 2.1 μm	0.248 - 2.1 μm	0.308 - 2.1 μm	0.248 - 2.1 μm
Maximum measurable energy ^a					
1064 nm, 150 μs	25 J	200 J	25 J	200 J	50 J
1064 nm, 7 ns	25 J	125 J	25 J	125 J	25 J
266 nm, 7 ns	20 J	35 J	20 J	35 J	20 J
Noise equivalent energy ^c	10 μJ	20 μJ	10 μJ	20 μJ	20 μJ
Max repetition frequency	100 Hz	100 Hz	100 Hz	100 Hz	20 Hz
Maximum pulse width (typical) ^d	0.7 ms	0.7 ms	0.7 ms	0.7 ms	5 ms
Rise time (typical 0-100%)	1 ms	1 ms	1 ms	1 ms	6 ms
Calibration uncertainty ^e	$\pm 3\%$	$\pm 3\%$	$\pm 3\%$	$\pm 3\%$	$\pm 3\%$
Repeatability	< 0.5%	< 0.5%	< 0.5%	< 0.5%	< 0.5%
DAMAGE THRESHOLDS					
Maximum average power	12 W	30 W	40 W	90 W	40 W
Maximum energy density					
1064 nm, 150 μs , 10 Hz	1.2 J/cm ²	14 J/cm ²	1.2 J/cm ²	14 J/cm ²	1.2 J/cm ²
1064 nm, 7 ns, single shot	0.6 J/cm ²	16 J/cm ²	0.6 J/cm ²	16 J/cm ²	0.6 J/cm ²
1064 nm, 7 ns, 10 Hz	0.6 J/cm ²	8 J/cm ²	0.6 J/cm ²	8 J/cm ²	0.6 J/cm ²
532 nm, 7 ns, 10 Hz	0.6 J/cm ²	6 J/cm ²	0.6 J/cm ²	6 J/cm ²	0.6 J/cm ²
266 nm, 7 ns, 10 Hz	0.5 J/cm ²	1 J/cm ²	0.5 J/cm ²	1 J/cm ²	0.5 J/cm ²
Maximum average power density ^f	10 W/cm ²	600 W/cm ²	10 W/cm ² ^h	600 W/cm ²	10 W/cm ²
PHYSICAL CHARACTERISTICS					
Effective aperture	65 x 65 mm	62 x 62 mm	65 x 65 mm	62 x 62 mm	65 x 65 mm
Absorber	MB	QED	MB	QED	MB
Dimensions	92H x 92W x 20D mm	95H x 97W x 25D mm	92H x 92W x 99D mm	95H x 97W x 104D mm	92H x 92W x 99D mm
Weight	440 g	440 g	900 g	900 g	900 g
ORDERING INFORMATION					
Available output options	DB15, USB or RS-232	DB15, USB or RS-232	DB15, USB or RS-232	DB15, USB or RS-232	DB15, USB or RS-232
Compatible stand	STAND-D-233	STAND-D-233	STAND-D-443	STAND-D-443	STAND-D-443
Product page					

a. Not exceeding maximum average power. Increasing pulse width increases the maximum measurable energy.
 b. Calibration at 2.1 to 2.5 μm is available on special request.
 c. Nominal value, actual value depends on electrical noise in the measurement system.
 d. Also available on special order: ELP (extra-long pulse) version.
 e. Excludes non-linearities.
 f. At maximum power.

QE95-MB

95 mm Ø, 15 µJ - 250 J



KEY FEATURES

- > **MODULAR CONCEPT**
Increase the power capability of your detector:
2 different cooling modules
- > **EXTRA LARGE APERTURE**
Effective aperture of 95 mm Ø
- > **QED ATTENUATOR AVAILABLE**
 - Measure up to 5X higher energies
 - Available with optional calibration,
all wavelengths between 532 & 1064 nm,
or single wavelength
- > **LOW NOISE LEVEL**
- > **TEST TARGET INCLUDED**

OUTPUT OPTIONS

- > **SMART INTERFACE**
Containing all the calibration data
- > **integra ALL-IN-ONE-METER**
Connects directly to a PC
Three models available:
 - USB output (-INT)
 - RS-232 output (-IDR)
 - USB with external trigger (-INE)

COMPATIBLE DISPLAYS & PC INTERFACES



MIRO ALTITUDE



MAESTRO



U-LINK



M-LINK



S-LINK

ACCESSORIES



Stand with delrin post
(200428, For -S model)



Stand with delrin post
(201284, For -H model)



DB15 to BNC adaptor



QED-95 attenuator



Pelican carrying case





QE95-MB

Specifications

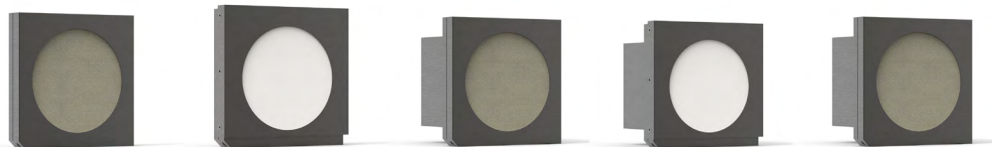

*Also traceable to NRC-CNRC



	QE95LP-S-MB	QE95LP-S-MB-QED	QE95LP-H-MB	QE95LP-H-MB-QED	QE95ELP-H-MB
MAX MEASURABLE ENERGY ^a	35 J	250 J	35 J	250 J	70 J
MAX REPETITION FREQUENCY	40 Hz	40 Hz	40 Hz	40 Hz	10 Hz
EFFECTIVE APERTURE	95 mm \emptyset	90 mm \emptyset	95 mm \emptyset	90 mm \emptyset	95 mm \emptyset
MEASUREMENT CAPABILITY					
Spectral range	0.19 - 20 μm	0.3 - 2.1 μm	0.19 - 20 μm	0.3 - 2.1 μm	0.19 - 20 μm
Calibrated spectral range ^b	0.248 - 2.1 μm	0.308 - 2.1 μm	0.248 - 2.1 μm	0.308 - 2.1 μm	0.248 - 2.1 μm
Maximum measurable energy ^a					
1064 nm, 150 μs	35 J	250 J	35 J	250 J	70 J
1064 nm, 7 ns	35 J	150 J	35 J	150 J	35 J
266 nm, 7 ns	30 J	50 J	30 J	50 J	30 J
Noise equivalent energy ^c	15 μJ	30 μJ	15 μJ	30 μJ	30 μJ
Max repetition frequency	40 Hz	40 Hz	40 Hz	40 Hz	10 Hz
Maximum pulse width (typical) ^d	1.5 ms	1.5 ms	1.5 ms	1.5 ms	5 ms
Rise time (typical 0-100%)	2 ms	2 ms	2 ms	2 ms	6 ms
Calibration uncertainty ^e	$\pm 3\%$	$\pm 3\%$	$\pm 3\%$	$\pm 3\%$	$\pm 3\%$
Repeatability	< 0.5%	< 0.5%	< 0.5%	< 0.5%	< 0.5%
DAMAGE THRESHOLDS					
Maximum average power	20 W	45 W	40 W	90 W	40 W
Maximum energy density					
1064 nm, 150 μs , 10 Hz	1.2 J/cm ²	14 J/cm ²	1.2 J/cm ²	14 J/cm ²	1.2 J/cm ²
1064 nm, 7 ns, single shot	0.6 J/cm ²	16 J/cm ²	0.6 J/cm ²	16 J/cm ²	0.6 J/cm ²
1064 nm, 7 ns, 10 Hz	0.6 J/cm ²	8 J/cm ²	0.6 J/cm ²	8 J/cm ²	0.6 J/cm ²
532 nm, 7 ns, 10 Hz	0.6 J/cm ²	6 J/cm ²	0.6 J/cm ²	6 J/cm ²	0.6 J/cm ²
266 nm, 7 ns, 10 Hz	0.5 J/cm ²	1 J/cm ²	0.5 J/cm ²	1 J/cm ²	0.5 J/cm ²
Maximum average power density ^f	10 W/cm ²	600 W/cm ²	10 W/cm ² ^h	600 W/cm ²	10 W/cm ²
PHYSICAL CHARACTERISTICS					
Effective aperture	95 mm \emptyset	90 mm \emptyset	95 mm \emptyset	90 mm \emptyset	95 mm \emptyset
Absorber	MB	QED	MB	QED	MB
Dimensions	122H x 122W x 20D mm	125H x 127W x 25D mm	122H x 122W x 99D mm	125H x 127W x 104D mm	122H x 122W x 99D mm
Weight	0.78 kg	0.78 kg	1.2 kg	1.2 kg	1.2 kg
ORDERING INFORMATION					
Available output options	DB15, USB or RS-232	DB15, USB or RS-232	DB15, USB or RS-232	DB15, USB or RS-232	DB15, USB or RS-232
Compatible stand	STAND-D-233	STAND-D-233	STAND-D-443	STAND-D-443	STAND-D-443
Product page					

- a. Not exceeding maximum average power. Increasing pulse width increases the maximum measurable energy.
- b. Calibration at 2.1 to 2.5 μm is available on special request.
- c. Nominal value, actual value depends on electrical noise in the measurement system.
- d. Also available on special order: ELP (extra-long pulse) version.
- e. Excludes non-linearities.
- f. At maximum power.

Specifications are subject to change without notice

QE12-MT

12 x 12 mm, 0.7 μ J - 3.9 J, tuned for high repetition rates

New product



KEY FEATURES

- > **MODULAR CONCEPT**
Increase the power capability of your detector:
2 different cooling modules
- > **LOW NOISE LEVEL**
- > **NEW MODELS FOR HIGH REPETITION RATES**
The QE12HR models are tuned for short pulses with
high repetition rates (up to 10 kHz)

OUTPUT OPTIONS

- > **SMART DB15 CONNECTOR**
Contains all the calibration data
- > **integra ALL-IN-ONE-METER**
Connects directly to a PC
Three models available:
 - USB output (-INT)
 - RS-232 output (-IDR)
 - USB with external trigger (-INE)

COMPATIBLE DISPLAYS & PC INTERFACES



MIRO ALTITUDE



MAESTRO



U-LINK



M-LINK



S-LINK

ACCESSORIES



Stand with delrin post



DB15 to BNC adaptor





QE12 attenuator



Pelican carrying case



	QE12SP-S-MT-D0	QE12SP-H-MT-D0	QE12HR-H-MT-D0
MAX MEASURABLE ENERGY ^a	0.70 J	0.70 J	0.70 J
MAX REPETITION FREQUENCY ^{b,c}	6 kHz	6 kHz	10 kHz
APERTURE	12 x 12 mm	12 x 12 mm	12 x 12 mm
MEASUREMENT CAPABILITY			
Spectral range	0.19 - 20 μm	0.19 - 20 μm	0.19 - 20 μm
Calibrated spectral range ^d	0.248 - 2.1 μm	0.248 - 2.1 μm	0.248 - 2.1 μm
Maximum measurable energy ^a			
1064 nm, 7 ns	0.70 J	0.70 J	0.70 J
266 nm, 7 ns	0.10 J	0.10 J	0.10 J
Noise equivalent energy ^e	0.8 μJ	0.8 μJ	1 μJ
Max repetition frequency ^{b,c}	6 kHz	6 kHz	10 kHz
Maximum pulse width (typical)	10 μs	10 μs	4 μs
Rise time width (typical 0-100%)	20 μs	20 μs	7 μs
Calibration uncertainty ^f	$\pm 3\%$	$\pm 3\%$	$\pm 3\%$
Repeatability	< 0.5%	< 0.5%	< 0.5%
DAMAGE THRESHOLDS			
Maximum average power	3 W	5 W	5 W
Maximum energy density			
1064 nm, 7 ns, single shot	0.50 J/cm ²	0.50 J/cm ²	0.50 J/cm ²
1064 nm, 7 ns, 10 Hz	0.50 J/cm ²	0.50 J/cm ²	0.50 J/cm ²
532 nm, 7 ns, 10 Hz	0.07 J/cm ²	0.07 J/cm ²	0.07 J/cm ²
266 nm, 7 ns, 10 Hz	0.07 J/cm ²	0.07 J/cm ²	0.07 J/cm ²
Maximum average power density ^g	10 W/cm ²	10 W/cm ²	10 W/cm ²
PHYSICAL CHARACTERISTICS			
Effective aperture	12 x 12 mm	12 x 12 mm	12 x 12 mm
Absorber	MT	MT	MT
Dimensions	36H x 36W x 14D mm	36H x 36W x 33D mm	36H x 36W x 33D mm
Weight	87 g	117 g	117 g
ORDERING INFORMATION			
Available output options	DB15, USB or RS-232	DB15, USB or RS-232	DB15, USB or RS-232
Compatible stand	STAND-D-233	STAND-D-233	STAND-D-233
Product page			

- a. Not exceeding maximum average power. Increasing pulse width increases the maximum measurable energy.
- b. With the IDR version, measured values are sampled when the repetition rate is > 200 Hz.
- c. Maximum 5.2 kHz with INT version.
- d. Calibration at 2.1 to 2.5 μm is available on special request.
- e. Nominal value, actual value depends on electrical noise in the measurement system.
- f. Excludes non-linearities.
- g. At maximum power.

QE25-MT

25 x 25 mm, 2 μ J - 23 J, tuned for high repetition rates

New product



KEY FEATURES

- > **MODULAR CONCEPT**
Increase the power capability of your detector:
2 different cooling modules
- > **LOW NOISE LEVEL**
- > **NEW MODELS FOR HIGH REPETITION RATES**
The QE25HR models are tuned for short pulses with
high repetition rates (up to 10 kHz)

OUTPUT OPTIONS

- > **SMART DB15 CONNECTOR**
Contains all the calibration data
- > **integra ALL-IN-ONE-METER**
Connects directly to a PC
Three models available:
 - USB output (-INT)
 - RS-232 output (-IDR)
 - USB with external trigger (-INE)

COMPATIBLE DISPLAYS & PC INTERFACES



MIRO ALTITUDE



MAESTRO



U-LINK



M-LINK



S-LINK

ACCESSORIES



Stand with delrin post



DB15 to BNC adaptor





QED-25 attenuator



Pelican carrying case



	QE25SP-S-MT-D0	QE25SP-H-MT-D0	QE25HR-H-MT-D0
MAX MEASURABLE ENERGY ^a	3.0 J	3.0 J	3.0 J
MAX REPETITION FREQUENCY ^{b,c}	6 kHz	6 kHz	10 kHz
EFFECTIVE APERTURE	25 x 25 mm	25 x 25 mm	25 x 25 mm
MEASUREMENT CAPABILITY			
Spectral range	0.19 - 20 μm	0.19 - 20 μm	0.19 - 20 μm
Calibrated spectral range ^d	0.248 - 2.1 μm	0.248 - 2.1 μm	0.248 - 2.1 μm
Maximum measurable energy ^a			
1064 nm, 7 ns	3.0 J	3.0 J	3.0 J
266 nm, 7 ns	0.44 J	0.44 J	0.44 J
Noise equivalent energy ^e	2 μJ	2 μJ	3 μJ
Max repetition frequency ^{b,c}	6 kHz	6 kHz	10 kHz
Maximum pulse width (typical)	10 μs	10 μs	4 μs
Rise time (typical 0-100%)	20 μs	20 μs	7 μs
Calibration uncertainty ^f	$\pm 3\%$	$\pm 3\%$	$\pm 3\%$
Repeatability	< 0.5%	< 0.5%	< 0.5%
DAMAGE THRESHOLDS			
Maximum average power	5 W	10 W	10W
Maximum energy density			
1064 nm, 7 ns, single shot	0.50 J/cm ²	0.50 J/cm ²	0.50 J/cm ²
1064 nm, 7 ns, 10 Hz	0.50 J/cm ²	0.50 J/cm ²	0.50 J/cm ²
532 nm, 7 ns, 10 Hz	0.07 J/cm ²	0.07 J/cm ²	0.07 J/cm ²
266 nm, 7 ns, 10 Hz	0.07 J/cm ²	0.07 J/cm ²	0.07 J/cm ²
Maximum average power density ^g	10 W/cm ²	10 W/cm ²	10 W/cm ²
PHYSICAL CHARACTERISTICS			
Effective aperture	25 x 25 mm	25 x 25 mm	25 x 25 mm
Absorber	MT	MT	MT
Dimensions	50H x 50W x 14D mm	50H x 50W x 53D mm	50H x 50W x 53D mm
Weight	193 g	193 g	193 g
ORDERING INFORMATION			
Available output options	DB15, USB or RS-232	DB15, USB or RS-232	DB15, USB or RS-232
Compatible stand	STAND-D-233	STAND-D-233	STAND-D-233
Product page			

- a. Not exceeding maximum average power. Increasing pulse width increases the maximum measurable energy.
- b. With the IDR version, measured values are sampled when the repetition rate is > 200 Hz.
- c. Maximum 5.2 kHz with INT version.
- d. Calibration at 2.1 to 2.5 μm is available on special request.
- e. Nominal value, actual value depends on electrical noise in the measurement system.
- f. Excludes non-linearities.
- g. At maximum power.

QE50-MT

50 x 50 mm, 10 μ J - 85 J



KEY FEATURES

- > **MODULAR CONCEPT**
Increase the power capability of your detector:
2 different cooling modules
- > **LOW NOISE LEVEL**
- > **QED ATTENUATOR AVAILABLE**
Measure up to 5X higher energies
Available with optional calibration, all
wavelengths between 532 & 1064 nm, or single
wavelength
- > **HIGH REPETITION RATE**
Measure each pulse at up to 4000 Hz

OUTPUT OPTIONS

- > **SMART DB15 CONNECTOR**
Contains all the calibration data
- > **integra ALL-IN-ONE-METER**
Connects directly to a PC
Three models available:
 - USB output (-INT)
 - RS-232 output (-IDR)
 - USB with external trigger (-INE)

COMPATIBLE DISPLAYS & PC INTERFACES



MIRO ALTITUDE



MAESTRO



U-LINK



M-LINK



S-LINK

ACCESSORIES



Stand with delrin post



DB15 to BNC adaptor

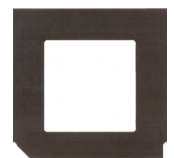



QED-50 attenuator



Pelican carrying case



	QE50SP-S-MT-D0	QE50SP-H-MT-D0
MAX MEASURABLE ENERGY ^a	13 J	13 J
MAX REPETITION FREQUENCY ^{b,c}	4000 Hz	4000 Hz
EFFECTIVE APERTURE	50 x 50 mm	50 x 50 mm
MEASUREMENT CAPABILITY		
Spectral range	0.19 - 20 μm	0.19 - 20 μm
Calibrated spectral range ^d	0.248 - 2.1 μm	0.248 - 2.1 μm
Maximum measurable energy ^a		
1064 nm, 7 ns	13 J	13 J
266 nm, 7 ns	1.8 J	1.8 J
Noise equivalent energy ^e	10 μJ	10 μJ
Max repetition frequency ^{b,c}	4000 Hz	4000 Hz
Maximum pulse width (typical)	10 μs	10 μs
Rise time (typical 0-100%)	20 μs	20 μs
Calibration uncertainty ^f	$\pm 3\%$	$\pm 3\%$
Repeatability	< 0.5%	< 0.5%
DAMAGE THRESHOLDS		
Maximum average power	10W	20W
Maximum energy density		
1064 nm, 7 ns, single shot	0.50 J/cm ²	0.50 J/cm ²
1064 nm, 7 ns, 10 Hz	0.50 J/cm ²	0.50 J/cm ²
532 nm, 7 ns, 10 Hz	0.07 J/cm ²	0.07 J/cm ²
266 nm, 7 ns, 10 Hz	0.07 J/cm ²	0.07 J/cm ²
Maximum average power density ^g	10 W/cm ²	10 W/cm ²
PHYSICAL CHARACTERISTICS		
Effective aperture	50 x 50 mm	50 x 50 mm
Absorber	MB	MB
Dimensions	75H x 75W x 15D mm	75H x 75W x 44D mm
Weight	209 g	338 g
ORDERING INFORMATION		
Available output options	DB15, USB or RS-232	DB15, USB or RS-232
Compatible stand	STAND-D-233	STAND-D-233
Product page		

- a. Not exceeding maximum average power. Increasing pulse width increases the maximum measurable energy.
- b. With the IDR version, measured values are sampled when the repetition rate is > 200 Hz.
- c. Maximum 5.2 kHz with INT version.
- d. Calibration at 2.1 to 2.5 μm is available on special request.
- e. Nominal value, actual value depends on electrical noise in the measurement system.
- f. Excludes non-linearities.
- g. At maximum power.

PRONTO-500-IPL

Portable laser probe for IPL sources, 2 - 350 J per pulse



KEY FEATURES

- > **HIGH ENERGY PER PULSE**
Accurate readings up to 350 J/pulse!
- > **EASY TO USE**
The touchscreen color LCD allows for a friendly user interface. You can make a measurement with just the touch of a button!
- > **DATA LOGGING**
Save your data to the internal memory and then transfer them to your PC over the USB connection.
- > **LARGE APERTURE**
55 mm Ø aperture to accommodate large beams
- > **RUGGED**
 - All-metal body
 - High damage thresholds
- > **PROTECTIVE WINDOW**
 - For measurements with gel-coupled IPL heads.
 - Protects the absorber, easy to clean
- > **SERIAL COMMANDS**
Serial commands are available to let you take full control of your PRONTO from your PC.

USER INTERFACE (SSE MODE)

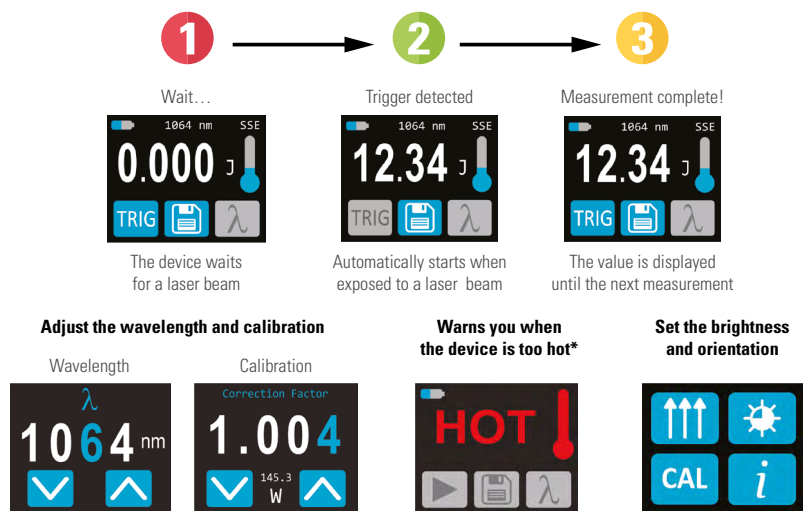

* Device may get hot, it is not recommended for handheld use when making a measurement

ACCESSORIES



Stand with steel post



Pelican carrying case

PRONTO-500-IPL

Specifications



*Also traceable to NRC-CNRC



PRONTO-500-IPL

MAX PULSE ENERGY (SINGLE SHOT)	350 J
EFFECTIVE APERTURE	55 mm \emptyset
APERTURE TYPE	Full aperture with protective window

MEASUREMENT CAPABILITY

Spectral range	0.19 - 2.5 μm
Calibrated spectral range	1064 nm
Energy range	2 - 350 J
Noise equivalent energy	500 mJ
Sensitivity	0.013 mV/J
Response time	2 s
Minimum repetition period	15 s (= time between measurements)
Maximum pulse width	433 ms
Accuracy	$\pm 5\%$

DAMAGE THRESHOLDS

Maximum average power density	45 kW/cm ² (1064 nm, 10 W, CW)
Pulsed laser damage threshold	175 J/cm ² (10 ms pulses)
Maximum allowable absorber temperature	65 °C

GENERAL SPECIFICATIONS

Display type	Touchscreen color LCD
Display size	28.0 x 35.0 mm (128 x 160 pixels)
Data storage	50 000 pts
Battery type	Rechargeable Li-ion
Battery life	17 hours or 4 200 measurements (with brightness set at 25%)
Battery recharge via	USB port

PHYSICAL CHARACTERISTICS

Effective aperture	55 mm \emptyset
Dimensions (sensor head)	88W x 88L x 32D mm (194L with handle)
Dimensions (monitor)	41W x 136L x 16D mm
Weight	930 g

ORDERING INFORMATION

Compatible stand	STAND-S-443
Product page	

POWER DETECTORS

ENERGY DETECTORS

BEAM PROFILING

TERAHERTZ DETECTORS

DISPLAYS & PC INTERFACES

CUSTOM / OEM PRODUCTS

CALORIMETERS

Measuring the highest energy laser beams

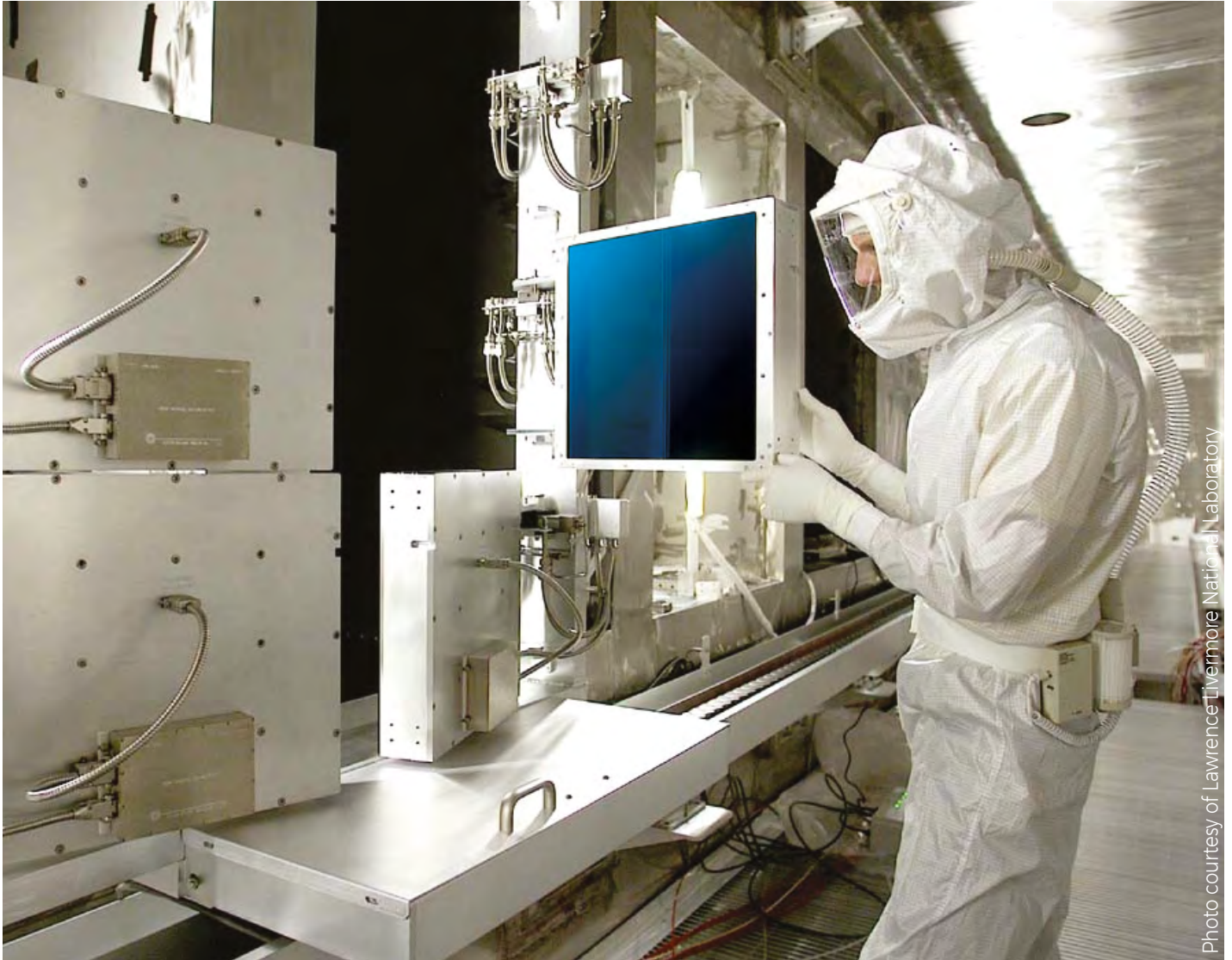

Photo courtesy of Lawrence Livermore National Laboratory

A Gentec-EO calorimeter is the only reliable solution available for the largest and highest energy laser beams. Through cooperation with several leading research facilities around the world, Gentec-EO has become the expert in manufacturing, calibrating and servicing calorimeters for use in high energy inertial confinement fusion calorimetric measurement.



STATE-OF-THE-ART

We work with a wide range of materials from surface coatings to the most robust volume absorbers to provide the best solution for your specific application.

- OUTSTANDING SIGNAL-TO-NOISE RATIO
- HIGH SENSITIVITY
- VACUUM COMPATIBILITY
- ATTENTION TO DETAILS AND WORKMANSHIP

With over 50 years of experience in thermal-based energy measurement, Gentec-EO is the ideal choice for all your high energy measurement needs.



ACCURATE

Using NIST traceable sources and proven calibration techniques, your Gentec-EO calorimeter is always the most accurate large aperture measurement device on the market.

With calibration uncertainties of $\pm 3\%$, and repeatabilities better than $\pm 2\%$ even for very large beams, Gentec-EO offers the very best solution for extreme energy measurements.



CUSTOMIZED

We have designed calorimeters for 16 kJ beams with apertures as large as 420 x 427 mm, and able to withstand pulse energy densities of more than 15 J/cm².

We have also provided smaller, highly-sensitive calorimeters for beam energies as low as 50 mJ for the most delicate applications.

Our calorimeters range from 190 nm to 20 microns. Moreover, we are happy to push these limits even further. We work with a wide range of materials from surface coatings to the most robust volume absorbers to provide the best solution for your specific application.

CALORIMETERS

Applications

LASER FUSION EXPERIMENTS

Inertial confinement fusion (ICF) is a process where nuclear fusion reactions are initiated by heating and compressing a fuel target, typically in the form of a pellet that most often contains a mixture of deuterium and tritium. To compress and heat the fuel, energy is delivered to the outer layer of the target using high-energy beams of laser light. ICF is said to reproduce the energy generation process taking place in the core of the sun.

Several laser fusion projects are underway around the world right now, their main goal is to produce a clean, reliable and nearly unlimited source of energy. All these laser fusion experiments use very high energy lasers of several kJ per pulse for which a Gentec-EO calorimeter is the ONLY reliable measuring device available on the market. Over the years, we have been presented with increasingly large and energetic laser pulses to be measured and we have kept pace with the world's most demanding lasers.

LASER FUSION MECHANISM

Schematic of the stages of inertial confinement fusion using lasers. The blue arrows represent radiation; orange is blowoff; purple is inwardly transported thermal energy.

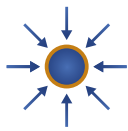

1.

Laser beams or laser-produced X-rays rapidly heat the surface of the fusion target, forming a surrounding plasma envelope.

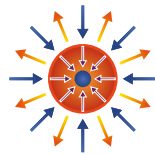

2.

Fuel is compressed by the rocket-like blowoff of the hot surface material.

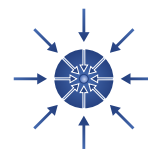

3.

During the final part of the capsule implosion, the fuel core reaches 20 times the density of lead and ignites at 100 000 000 °C.



4.

Thermonuclear burn spreads rapidly through the compressed fuel, yielding many times the input energy.

EXTREME PEAK POWER APPLICATIONS

Ultrashort pulsed lasers are developing at a very fast pace. Some lasers now feature peak powers in the petawatts (10^{15} W). Furthermore, the beam sizes can be fairly small, which results in peak power densities too high for a standard detector. Typically, pulse values for these lasers are in the range:

Beam sizes: up to 160 mm Ø

Energy range: 1 J to 100 J

Pulse widths: femtosecond & picosecond

Wavelengths: UV to NIR

For these, a Gentec-EO calorimeter is the only reliable solution. Furthermore, it can sometimes be used in power mode.

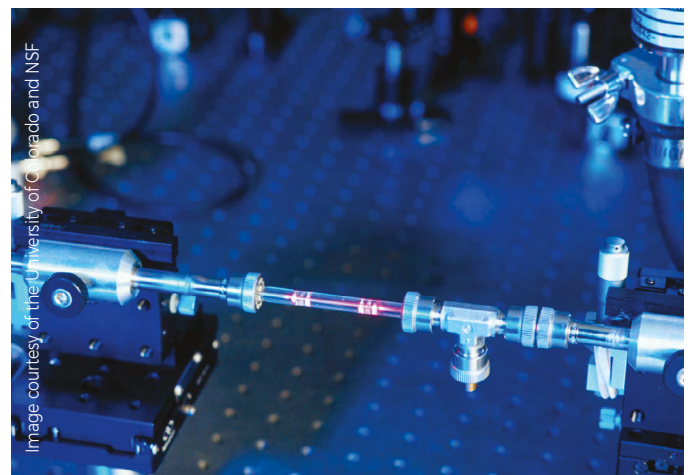

CALORIMETERS

Technical aspects

EXAMPLES OF CUSTOM CALORIMETERS

	SPECTRAL RANGE	MINIMUM ENERGY	MAXIMUM ENERGY *
RECTANGULAR APERTURES			
420 x 427 mm	1053 nm	500 J	16 000 J
420 x 427 mm	351/532/1053 nm	200 J	5000 J
110 x 110 mm	351/532/1053 nm	1 J	50 J
400 x 400 mm	351/532/1053 nm	200 J	5000 J
230 x 230 mm	532/1064 nm	100 J	1500 J
ROUND APERTURES			
310 mm Ø	351 nm	20 J	500 J
310 mm Ø	0.35 - 1.1 µm	200 J	1500 J
150 mm Ø	0.3 - 1.1 µm	1 J	500 J
50 mm Ø	0.19 - 10 µm	15 mJ	200 J
19 mm Ø	0.19 - 25 µm	1 mJ	2.3 J

* Maximum measurable energy depends on pulse width and wavelength.

MONITORING

PC
INTERFACE



Single-channel power & energy
PC interface (USB or RS-232)

The P-LINK is the perfect PC interface to be integrated into your system and used remotely. You have the choice between USB or RS-232 connection. The P-LINK comes with a complete acquisition software (PC-CALO).

ACQUISITION
SOFTWARE

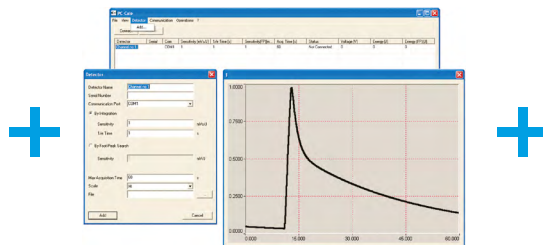

Can handle several calorimeters saves data
to the PC graphic display

The PC-CALO is a user-friendly PC interface that reads and controls several channels simultaneously. It reads the voltage outputs of the PC interface, saves the data in a spreadsheet, displays the data graphically and analyzes the measured energy. The parameters are entered separately and the data can be treated individually or simultaneously.

REMOTE
SYSTEM DIAGNOSTICS



Validation of the calibration
Verification of the signal response

Do the on-site monitoring of your calorimeter using our special diagnostic tool. The verification is done remotely so you can control it from another location. The diagnostic includes the verification of the calorimeter's calibration and of the signal response and data acquisition.

ABSORPTION CURVES

QE-MT & QE-MB

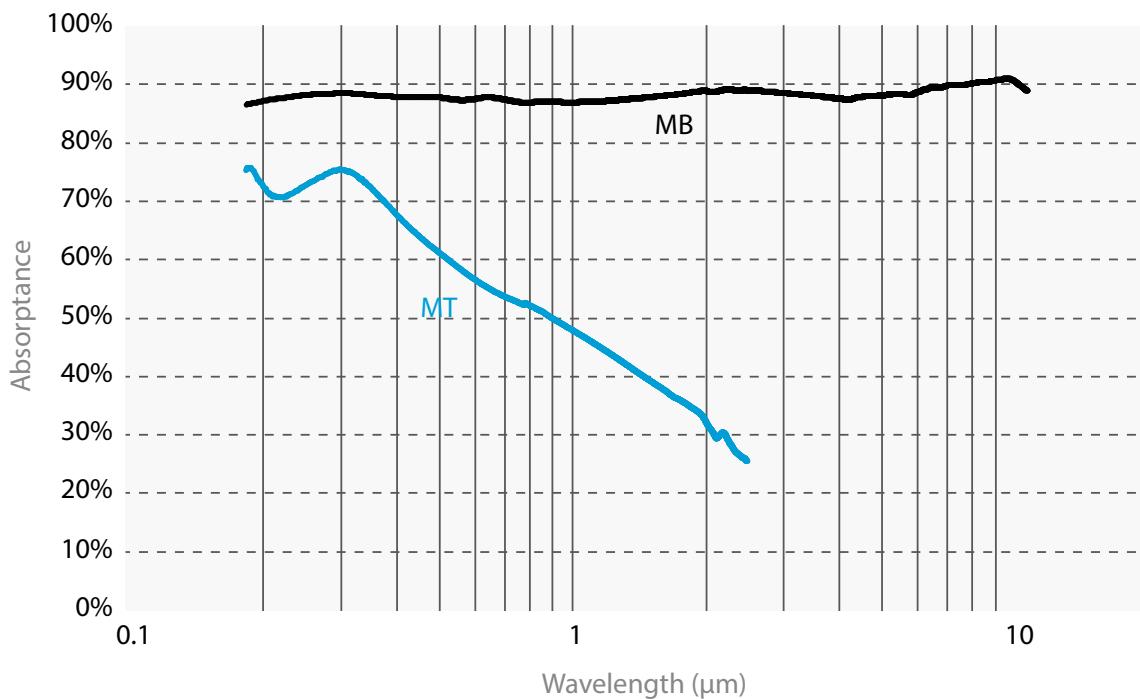

M6-Si & M6-IN

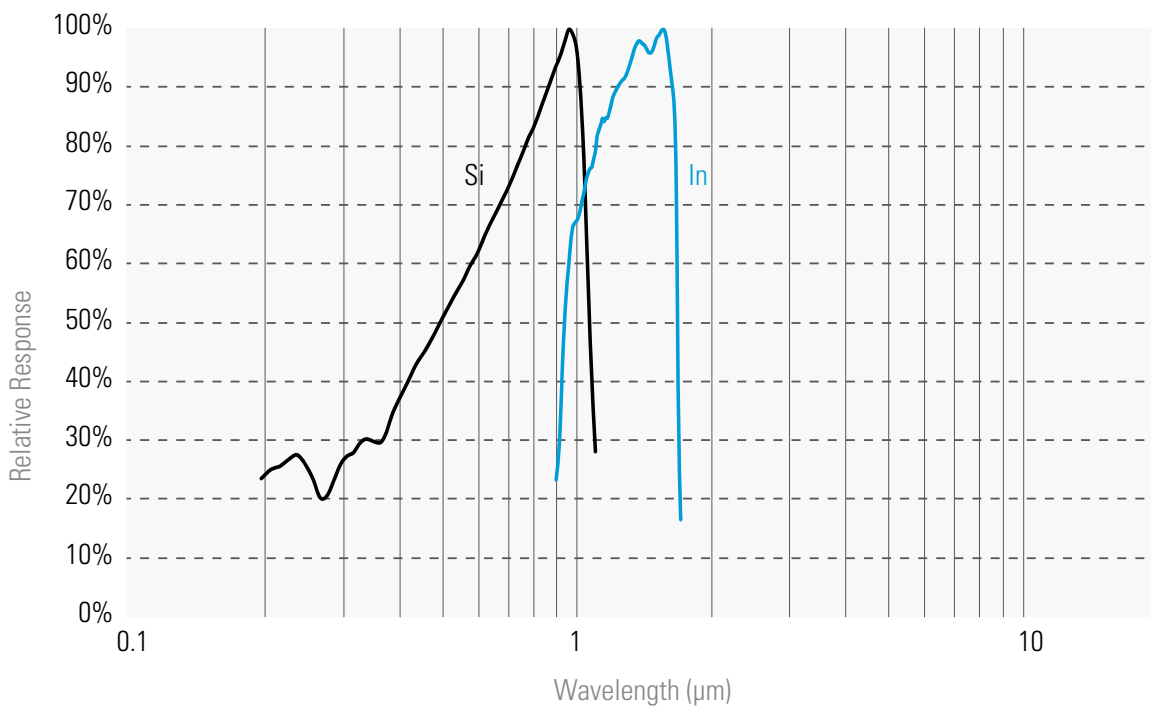

ABSORPTION CURVES

QED attenuators

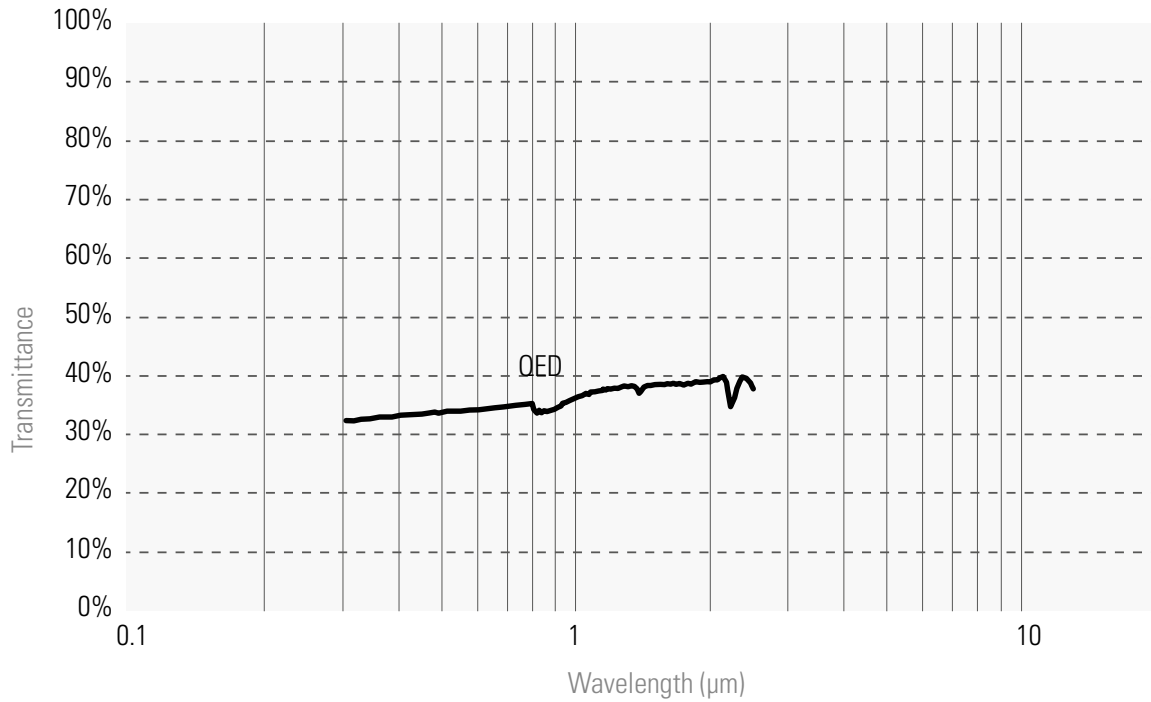

QE-B & UM-B

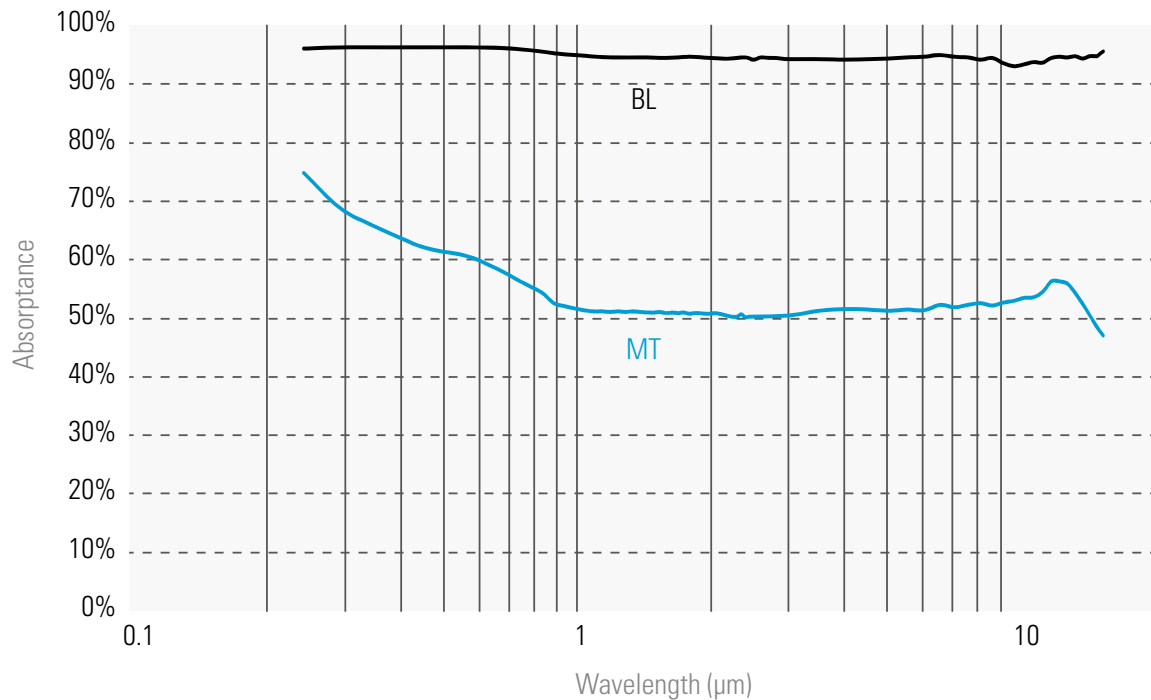

ABSORPTION CURVES

PE10B-Si sensitivity

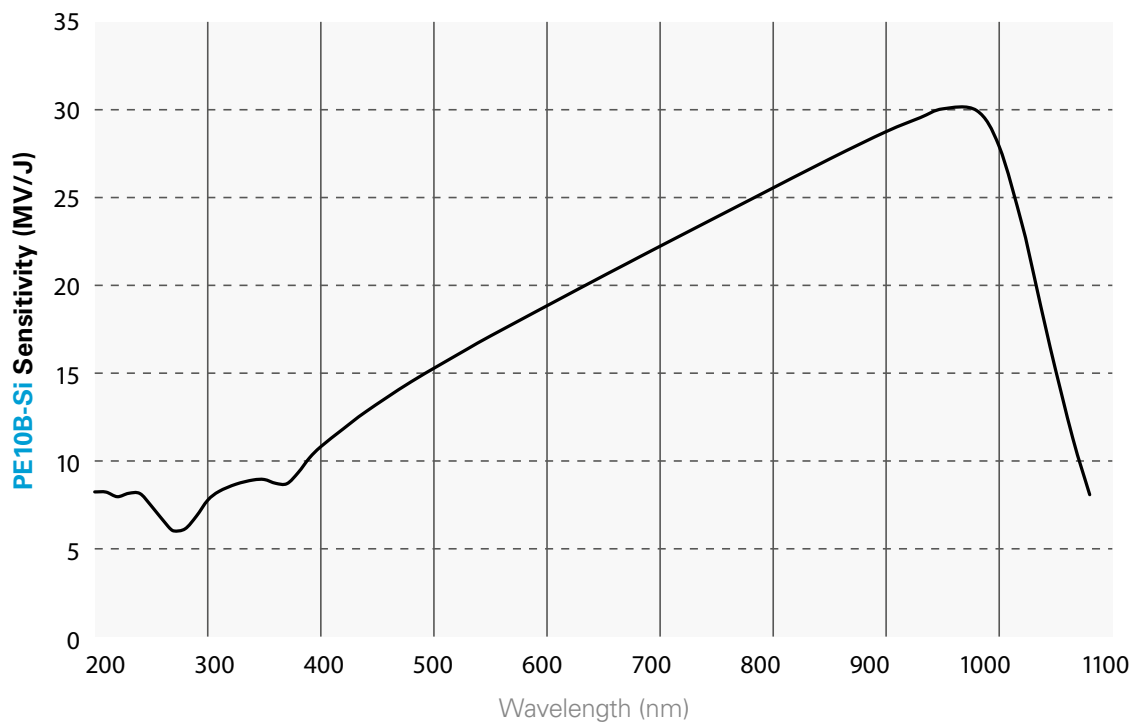

PE10B-Si maximum energy

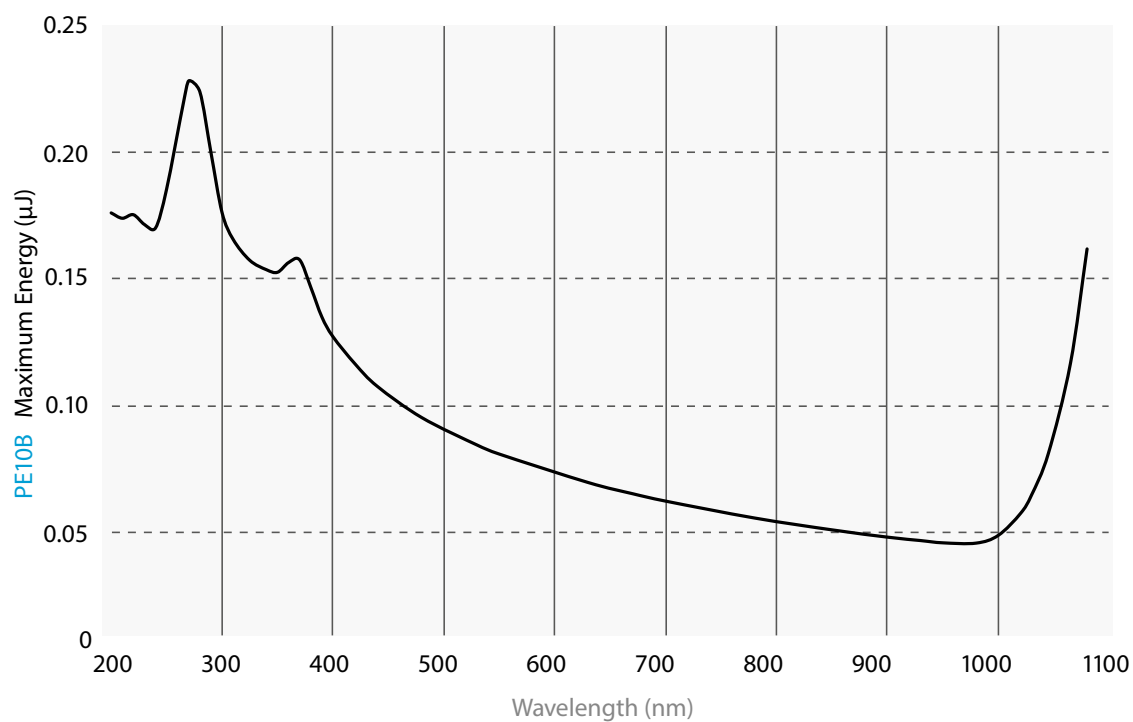

ABSORPTION CURVES

PE5B-GE sensitivity

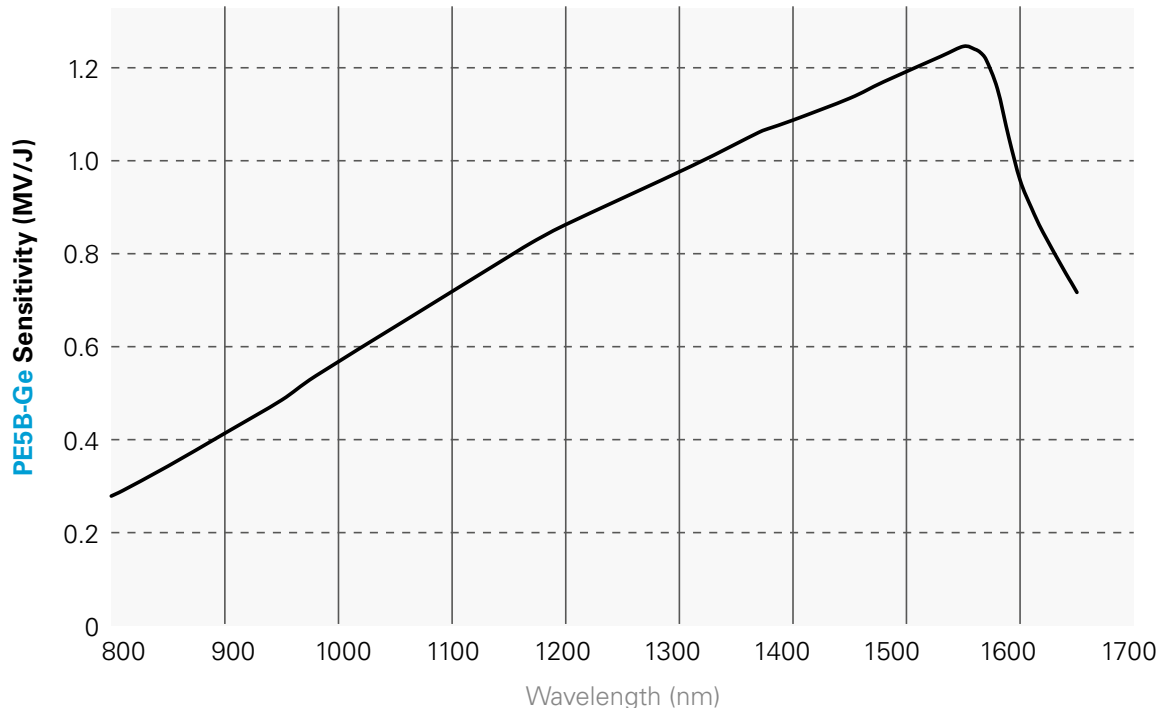

PE5B-GE maximum energy

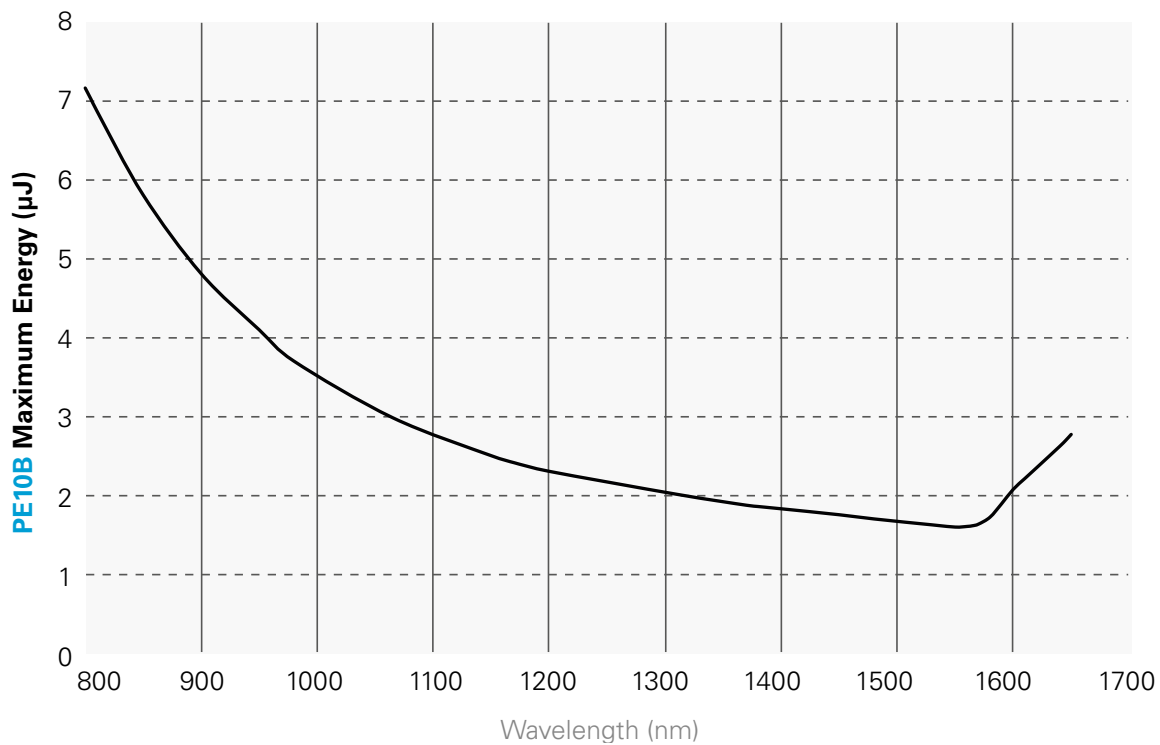

BEAM PROFILING

Overview of the different models



BEAM PROFILING CAMERAS

Profiling a laser beam is a convenient complement to the measurement of its power or energy because it provides very useful additional information, like spatial energy or intensity distribution, beam widths, centroid, ellipticity and orientation, that may help you determine if your laser-based systems are operating optimally.

The Beamage is the most cost-effective USB3.0 Beam Profiling Camera on the market. It is available for UV to IR wavelengths and in 2 sizes. It comes with an intuitive and complete software that features an array of useful tools and functions. Its calculations are ISO compliant.

MAIN SPECIFICATIONS

	BEAMAGE-4M	BEAMAGE-4M-IR	BEAMAGE-4M-FOCUS
Wavelength range			
Camera only	350 - 1150 nm	1495 - 1595 nm	350 - 1150 nm
With UG11-UV filter	250 - 370 nm	---	---
With B3-IR-Filter	1250 - 1350 nm	---	---
Pixel count	4.2 MPixels	4.2 MPixels	4.2 MPixels
H x V	2048 x 2048	2048 x 2048	2048 x 2048
Sensor size	11.3 x 11.3 mm	11.3 x 11.3 mm	20.5 x 20.5 mm
Frame rate (full frame)	6.2 fps	6.2 fps	6.2 fps

BEAM QUALITY MEASUREMENT

The performance of a laser in practical applications is critical in the design of optical systems and focusing applications, and it can be quantified by measuring M2, the laser beam quality factor, which indicates how close a laser is to being an ideal Gaussian beam.

The Beamage-M2 acquires a sequence of beam profile measurements to automatically perform beam quality measurements within a few seconds. It is equipped with the largest optics on the market for easy alignment and fast measurements that you can trust. Its software is both intuitive and ISO compliant.



ACCESSORIES

Specifications



IF YOUR **LASER SPECIFICATIONS EXCEED THE LIMITS** IN TERMS OF

- > **WAVELENGTH**
- > **BEAM SIZE**
- > **LASER POWER**

YOU CAN MANAGE THEM WITH THE ACCESSORIES PRESENTED BELOW

MANAGE THE WAVELENGTH



Since CMOS sensors are not sensitive to every frequency of the electromagnetic spectrum, we offer several wavelength management solutions to enhance the capabilities of the Beamage beam profiling cameras.

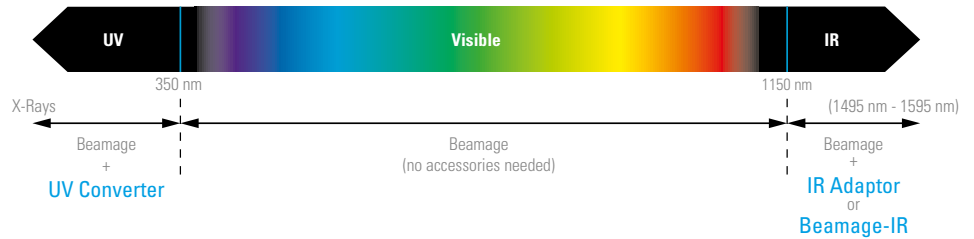

MANAGE THE BEAM SIZE



A simple solution is offered to those who need to profile beams that are larger than the CMOS sensor (> 11.3 mm x 11.3 mm). This solution is a beam reducing optical component called camera lens. It works either by indirectly imaging the transmission of the beam after it has passed through a diffusing element or by directly imaging the beam that is incident on a Gentec-EO detector or beam dump.

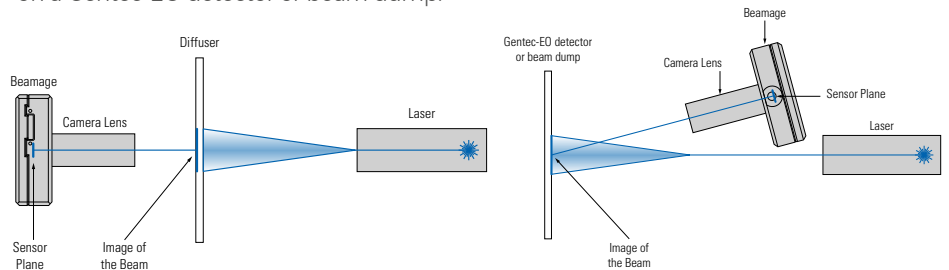

MANAGE THE LASER POWER



CMOS sensors have low saturation levels as well as low damage thresholds. It is thus very important that you control your laser power to get the best measurement possible and avoid damaging the Beamage camera.

- For laser power under 1 W, you can attenuate the beam with ND filters
- For laser power up to 1000 W, you can sample a small fraction of the beam with a BA optical sampler

BEAMAGE

CMOS beam profiling cameras



KEY FEATURES

- > **USB 3.0 FOR THE FASTEST TRANSFER RATES**
Up to 10X faster than regular USB 2.0 connections
- > **HIGH RESOLUTION**
4.2 Mpixels resolution gives accurate profile measurements of very small beams
- > **LARGE APERTURES**
 - 11.3 x 11.3 mm for the Beamage-4M
 - 20.5 x 20.5 mm for the Beamage-4M-FOCUS
- > **AVAILABLE WITH IR COATING**
Beamage 4M-IR cameras have a special phosphor coating for IR wavelengths (1495-1595 nm)
- > **ISO COMPLIANT**
D4 definition of diameter, centroid, ellipticity and orientation are ISO 11146:2004 and 11146:2005 compliant
- > **EXTERNAL TRIGGER**
To synchronize the camera with a pulsed laser

INTUITIVE SOFTWARE INTERFACE

Easy to navigate interface, with many displays and control features:

- 2D, 3D and XY Displays
- Background Subtraction Function
- Unique "Animate" Function
- Gaussian Fit
- Semi-Log Graph

ACCESSORIES



Stand with delrin post



BA series optical attenuators



Stackable ND filters (0.5, 1.0, 2.0, 3.0, 4.0 & 5.0)



UV and IR filters



Pelican carrying case



Fiber adaptors & connectors (FC, ST and SMA)



UV converters & IR adaptors



	BEAMAGE-4M	BEAMAGE-4M-IR	BEAMAGE-4M-FOCUS
SENSOR TECHNOLOGY	CMOS	CMOS (with phosphor coating)	CMOS (with fiber optic taper)
EFFECTIVE APERTURE	11.3 x 11.3 mm	11.3 x 11.3 mm	20.5 X 20.5 mm ^a
MEASUREMENT CAPABILITY			
Wavelength range			
Camera only	350 - 1150 nm	1495 - 1595 nm	350 - 1150 nm
With UG11-UV filter	250 - 370 nm	---	---
With B3-IR-filter	1250 - 1350 nm	---	---
Pixel count	4.2 MPixels	4.2 MPixels	4.2 MPixels
H x V	2048 x 2048	2048 x 2048	2048 x 2048
Minimum measurable beam	55 μm	70 μm	120 μm
Frame rate		6.2 fps at 4.2 MPixels (Full Frame) 11.4 fps at 2.1 MPixels (2048 x 2048) 18.6 fps at 1.1 MPixels (2048 x 544) 32 fps at 0.066 MPixels (256 x 256)	
RMS noise	1000:1 (60 dB)	1000:1 (60 dB)	1000:1 (60 dB)
DAMAGE THRESHOLDS			
Maximum average power	1 W with ND filter	1 W with ND filter	1 W with ND filter
Maximum density (1064 nm)	10 W/cm ² 0.1 J/cm ²	10 W/cm ² 0.1 J/cm ²	10 W/cm ² 0.1 J/cm ²
SOFTWARE			
Displays	2D, 3D, XY and Beam Tracking		
Display Features	2D: Print Screen, Reset View, Show/Hide Beam Diameter 3D: Print Screen, Reset View, Top View XY: Save Data, Zoom, Gaussian Fit, Semi-Log, Show/Hide Cursor, Show/Hide FWHM, Show/Hide 1/e ² Beam Tracking: Save Data, Print Screen, Reset View, Zoom		
Beam Diameter Definitions	D4σ (ISO compliant), 1/e ² along crosshairs (13.5%) FWHM along crosshairs (50%) Custom (%)		
Buffer Controls	Open File, Save Current Data, Save All Data, Previous/Next Image, Clear Buffer, Animate		
Printing and Reports	Full Report in Print Ready Format (2D, 3D, XY, Measures, Parameters) Print Screen in BMP format (2D and 3D)		
PHYSICAL CHARACTERISTICS			
Sensor size	11.3 x 11.3 mm	11.3 x 11.3 mm	11.3 x 11.3 mm
Sensor area	1.28 cm ²	1.28 cm ²	1.28 cm ²
Effective aperture	Same as sensor	Same as sensor	20.5 x 20.5 mm
Dimensions (not including filter)	61H x 81.1W x 19.7D mm	61H x 81.1W x 19.7D mm	61H x 81.1W x 46.5D mm
Weight (head only)	138 g	138 g	235 g
ORDERING INFORMATION			
Compatible stand	STAND-D-233	STAND-D-233	STAND-D-233
Product page			

a. With a typical pixel multiplication factor (PMF) of 1.8.

BEAMAGE

Software features

Capture Controls:

Start/Stop,
Subtract Background

Buffer Controls:

View Data Offline

Data:

Computation

File Controls:

Save and Open Data

Startup Configuration:

Save and Load Settings

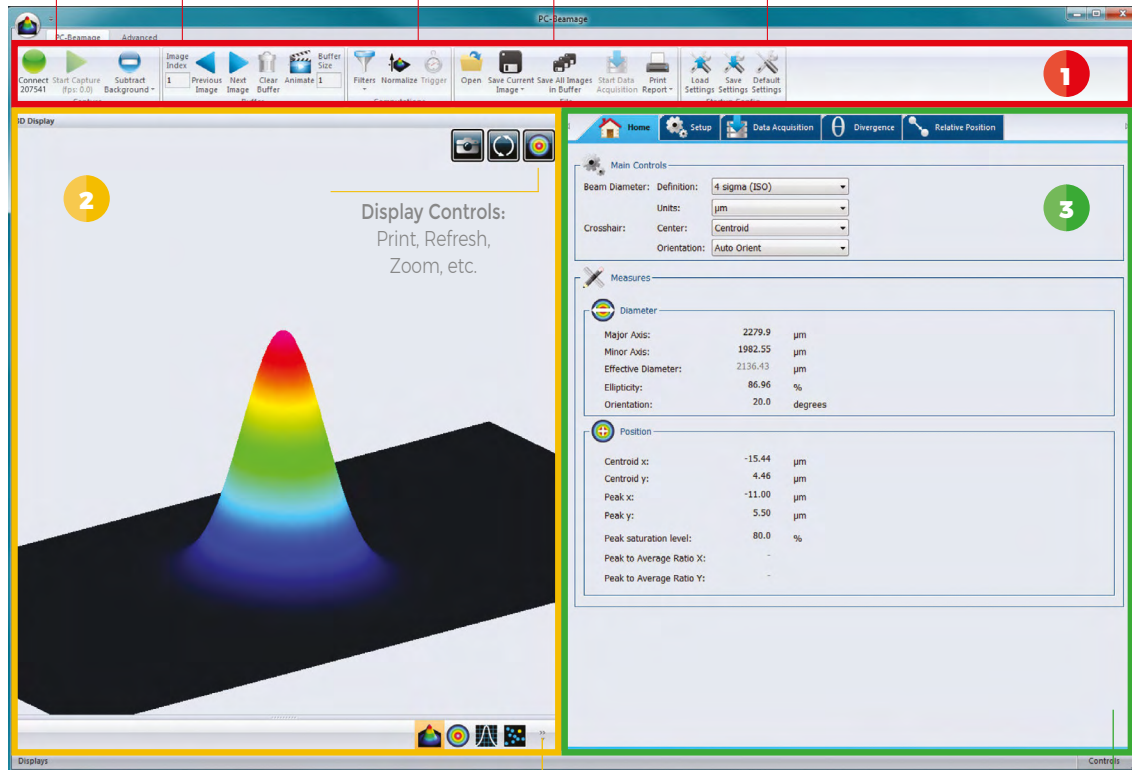

Displays:
3D, 2D, XY Graphs and Beam Tracking

Home, Setup and Acquisition Tabs:
Set your capture parameters and get the resulting measurements

1

MAIN CONTROLS

The upper part of the software includes all the main controls in a ribbon format. These controls are grouped by family: Capture Controls, File Controls, Buffer Controls, M2 Controls and Data Computations. The last includes very useful filters and a normalization function.

2

DISPLAYS

The left-hand side of the software is the display panel. Four displays are available: 3D, 2D, XY (cross-sectional graphs along the crosshairs) and Beam Tracking. The desired display is selected by clicking on the corresponding icon at the bottom of the panel. Print screen controls are available for the 3D, 2D and Beam Tracking displays. They allow the user to save an image of the current view in BMP format.

3

HOME AND SETUP TABS

The right-hand side of the software contains the Home, Setup and Data Acquisition tabs. The Home tab allows the user to select the main controls for his measurements (Beam Diameter Definition, Crosshair Center and Orientation) and displays the resulting measurements below. The Setup tab allows the user to set the measurement parameters (Exposure Time, Image Orientation and Averaging, Active Area, etc.) and the Data Acquisition tab allows the user to save measurements with or without full images, to enter the Sampling Rates and a Total Duration for the Acquisition. More tabs with advanced controls are available when clicking on the Show/Hide Options button in the Computations panel.

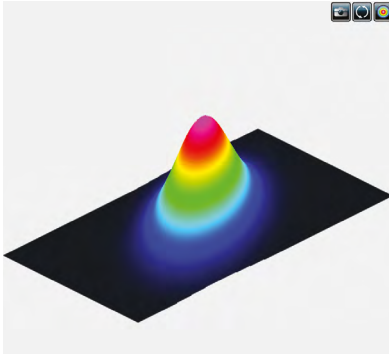

3D DISPLAY

The 3D display shows the actual shape of the beam. It is possible to easily zoom, pan and rotate the image. The Reset button puts the data back in its original configuration. This display also features a Print Screen button to save the latest image in BMP format.

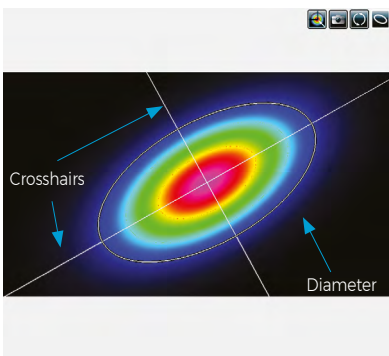

2D DISPLAY

The 2D display features the crosshairs (set to the major and minor axis or along a specific angle) and the measured diameters of the beam. These diameters vary with the chosen definition (4-sigma, FWHM, 1/e², etc.) and the display can be turned ON or OFF. The Print Screen button allows to save a picture of the current screen in BMP format.

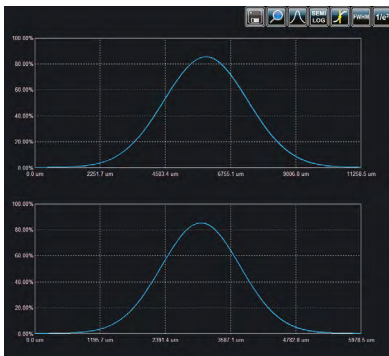

XY DISPLAY

The XY display plots cross-sectional graphs of the beam along the crosshairs. This display features many useful tools like zoom, cursor, and FWHM and 1/e² level bars. It is also possible to display the graphs in semi-log format to enhance the details in the low intensity parts of the beam.

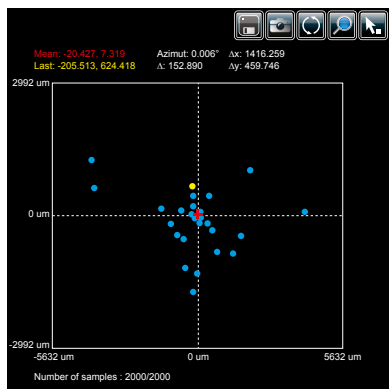
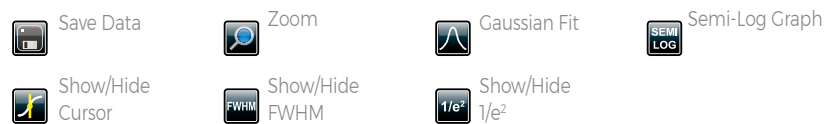

BEAM TRACKING DISPLAY

The Beam Tracking Display allows the user to visualize the variation of the beam's centroid position on the sensor. This display shows the latest calculated position as well as the previous ones, until the user resets the view. The display also shows the mean position of all computed values and gives information regarding position stability for both X and Y axes. This tool is great to monitor the beam pointing stability over time.

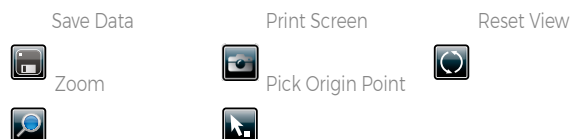

BEAMAGE-M2

Automated M² measurement system



KEY FEATURES

- **LARGE APERTURES**
The only M² system on the market equipped with a complete set of 50mm (2") optics. Also, the sensor is 11.3 x 11.3mm
- **SIMPLE ALIGNMENT**
Two beam-steering mirrors are included for quick and easy alignment of your laser into the system.
- **COMPACT**
The low-profile ingenious mechanics make it easy to fit the device on any optical table
- **ISO COMPLIANT**
The calculations are fully compliant to the ISO 11146 and 13694 standards
- **FAST ACQUISITION**
Make a complete, ISO-compliant measurement in only 20 seconds with the ROI feature and in less than a minute with full-frame acquisition
- **FLEXIBLE & INTUITIVE SOFTWARE**

AUTOMATED MEASUREMENTS

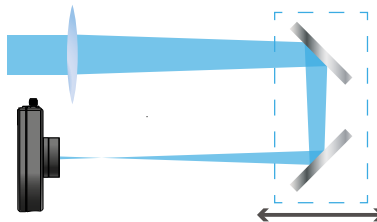

Inside the BEAMAGE-M2, a computer-controlled motorized rail allows precise positioning of two mirrors, which in turn allow a 400 mm beam path difference. At each position of the translation stage, a beam profile is acquired and the beam diameter is measured. The automation of the translation stage allowed by the software is the key to a fast measurement.

PRACTICAL ALIGNMENT TOOL



Each BEAMAGE-M2 system includes an alignment tube that helps you set up the system faster. Simply use the two alignment mirrors to center your laser beam onto both irises, and you will be ready to start measuring in no time!

The fluorescent material around the pinholes also helps to align beams that are in the NIR range without having to use an IR viewer.

BEAMAGE-M2

Specifications



BEAMAGE-M2

SENSOR TECHNOLOGY	Beamage-4M included
EFFECTIVE APERTURE	Ø 48 mm optics - 11.3 x 11.3 mm sensor
MEASUREMENT CAPABILITY	
System wavelength range	350 - 1100 nm
Attenuation range	3 Flip-mount attenuators for 8 levels of attenuation: no attenuation, ND0.5, ND1, ND2, ND1.5, ND2.5, ND3, ND3.5
Beam diameter range ^a	55 µm to 11.3/3 mm
Translation stage	
Mechanical travel range	200 mm
Effective optical path range	400 mm
Lens focal length	5 AR-coated lenses included: 200 mm, 250 mm, 300 mm, 400 mm and 500 mm
Typical M ² accuracy ^b	± 5%
Typical M ² repeatability ^b	± 2%
Applicable light sources	CW and quasi-CW
Typical measurement time	45 s with full-frame acquisition
DAMAGE THRESHOLDS ^c	
Maximum average power	1 W with ND filter
Maximum density (1064 nm)	CW: 10 W/cm ² ; Pulsed: 0.1 J/cm ²
PHYSICAL CHARACTERISTICS	
Dimensions	
Main enclosure	357 mm (L) x 165 mm (W) x 135 mm (H)
Total (including external mirrors)	602 mm (L) x 193 mm (W) x 172 mm (H)
Optical axis height	86 mm
Weight	6.6 kg
Power supply	48 VDC, 1.25A out
SOFTWARE	
Displays	2D, 3D, XY, Beam Tracking and M ²
Beam diameter definitions	D4σ 1/e ² along crosshairs (13.5%) FWHM along crosshairs (50%) Custom (%)
Beam quality definitions	Laser beam quality M ² : M ² _x , M ² _y (ISO compliant) Beam Propagation Factor: BPP _x , BPP _y Width at waist: W _x , W _y Waist location and offset: Z _x , Z _y , ΔZ Divergence angle: θ _x , θ _y Rayleigh length: Z _{Rx} , Z _{Ry} Astigmatism
Printing and reports	Full report in print-ready format
ORDERING INFORMATION	
Product page	

Specifications in the table above are for the use with a Beamage-4M beam profiler (included in the Beamage-M2 kit)

- a. At the Beamage sensor
- b. Depending on the beam quality and optical configuration
- c. With ND4 filter at the Beamage

Specifications are subject to change without notice

BEAMAGE-M2

Software features

Select which set of Rayleigh range boundaries to display on the graph: X, Y or both

M2 Results tab:
View and understand all the measured parameters quickly, for both the initial laser beam and the beam inside the BEAMAGE-M2 system

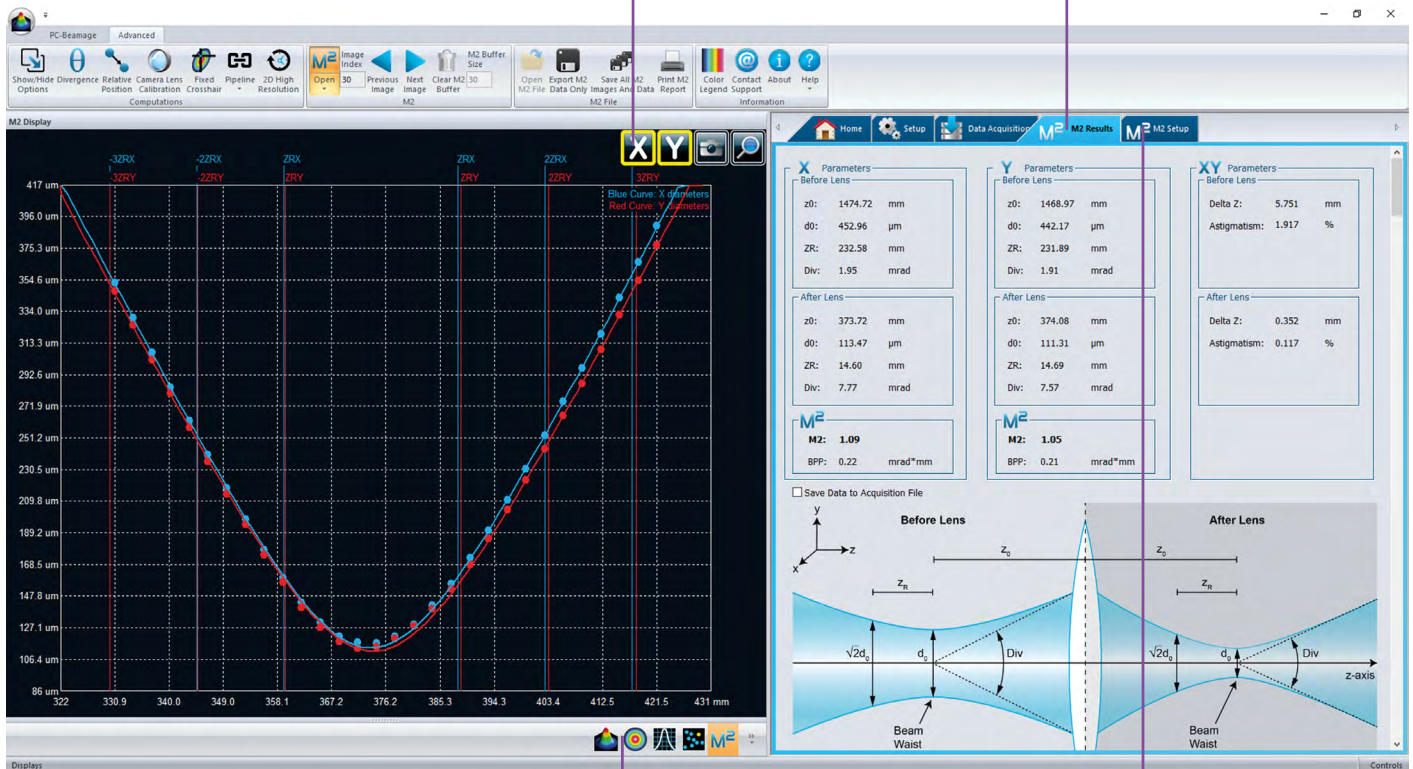

Switch to 3D or 2D displays to see each of the measured profiles

M2 Setup tab:
Control your acquisition parameters

BEAMAGE-M2

Software features

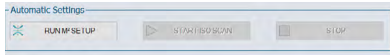

ISO COMPLIANCE MADE SIMPLE

With the “RUN M2 SETUP” button, the software automatically defines new parameters for a more precise M² measurement. The “ISO SCAN” data set complies with the ISO-11146 M² measurement standard, being spread between $-3Z_R$ and $+3Z_R$.

The automatic settings are updated after each calculation, considering the values of Z_0 and Z_R from the latest measurement.

By default, the results graph always shows the calculated positions of the first three Rayleigh distances on each side of the waist.

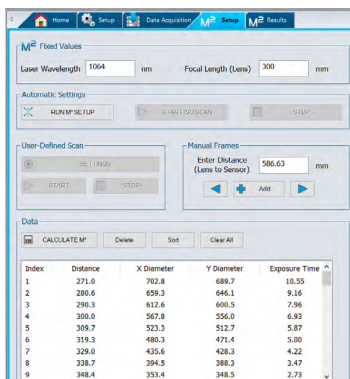

FULL CONTROL ON YOUR DATA

During an M² scan, each of the measured profiles is saved and the flexible software gives you complete control on your acquired data.

- View each acquired profile in 2D display or 3D display.
- Add measurement points to a data set at the position of your choice with the “ADD” button.
- Remove unwanted profiles from your data set & recalculate the measurements.



FAST ATTENUATION

Add or remove attenuation with the flick of a finger. The software adjusts the exposure time at each frame during an acquisition, and advises the user on the required attenuation.

ND

Neutral density (ND) filters - up to 1 W



KEY FEATURES

> FOR ALL BEAMAGE MODELS

We offer various SM1-threaded absorptive ND filters that can be fixed directly on the aperture of the Beamage camera via a SM1 to C-mount adaptor. We also offer SM2-threaded filters that can be fixed on the Beamage-4M-FOCUS via a SM2 to T-Mount adaptor.

> HIGH-QUALITY OPTICS

These filters reduce the intensity of all wavelengths without affecting the wavefront of the beam or distorting the image.

> STACKABLE ATTENUATION

Subsequent filters can be stacked directly on each other. Sets of 3 filters or 6 filters as well as individual filters are available.

COMPATIBLE PRODUCTS



BEAMAGE-4M



BEAMAGE-4M-FOCUS



PH series

OVERVIEW OF THE MODELS

MODEL NAME		EQUIVALENT ATTENUATION	TRANSMITTANCE AT 633 NM
SM1 FILTERS	SM2 FILTERS		
ND0.5	ND0.5-FOCUS	(1/3.16)	~32%
ND1.0	ND1.0-FOCUS	(1/10)	~10%
ND2.0	ND2.0-FOCUS	(1/100)	~1%
ND3.0	ND3.0-FOCUS	(1/1000)	~0.1%
ND4.0	ND4.0-FOCUS	(1/10 000)	~0.01%
ND5.0	ND5.0-FOCUS	(1/100 000)	~0.001%
NDSET-6 (Set of 6 filters)			
NDSET-3 (Set of 3 filters: ND1, ND2, ND3)			
ND-H (ND filter holder)			



ND0.5 TO ND5.0

Spectral range	400 nm ^a - 1595 nm
Filter diameter	25 mm Ø
Clear aperture	22.5 mm Ø (90% of diameter)
Dimensional tolerance	+0.0/-0.25 mm
Optical density tolerance	± 5%
Parallelism	< 10 arcsec
Transmitted wavefront error	< $\lambda/10$ at 633 nm
Surface flatness	< $\lambda/4$
Surface quality	40 - 20 Scratch-Dig
Maximum power	1 W
Damage thresholds	100 W/cm ² or 3 J/cm ²
Product page	

* Data specified at 633 nm
 a. For ND4.0 filter, lower limit with other models.

SPECTRAL TRANSMISSION OF ALL FILTERS

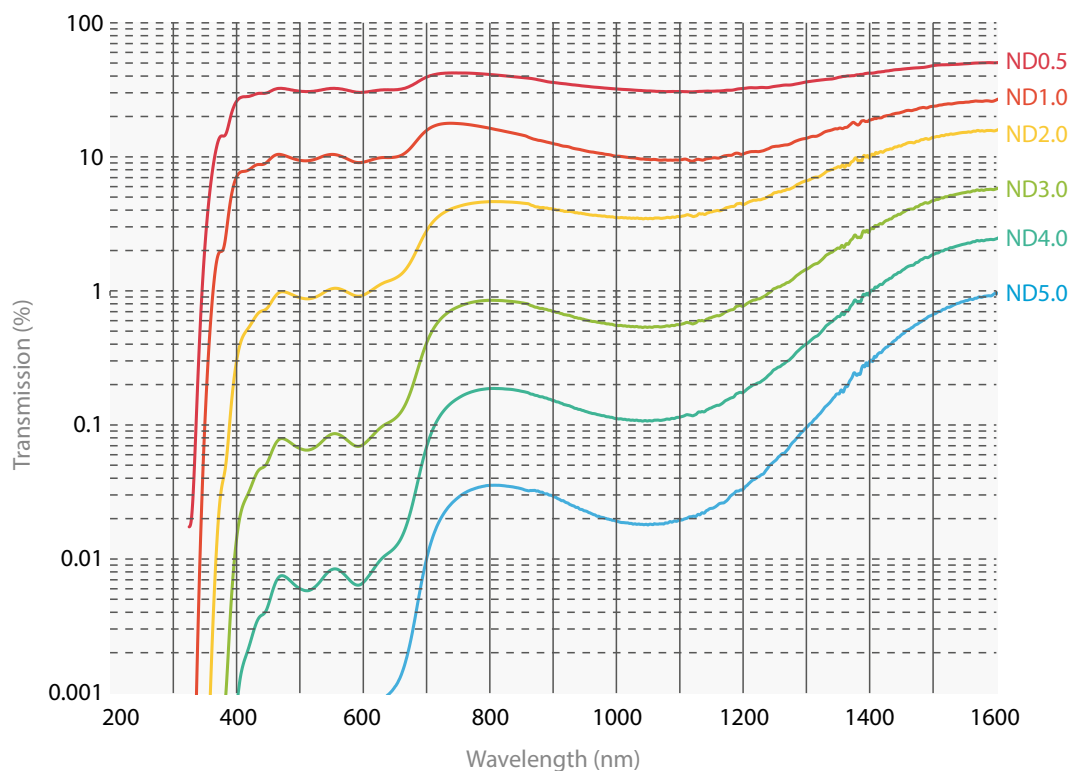

Specifications are subject to change without notice

BA

Optical attenuators - up to 1 kW

New product



KEY FEATURES

- > **MANAGE THE LASER POWER**
CMOS sensors have low saturation levels as well as low damage thresholds. It is thus very important that you control your laser power to get the best measurement possible and avoid damaging the BEAMAGE camera.
- > **SAMPLE YOUR LASER BEAM**
The BA series optical attenuators use Fresnel reflections on two orthogonal wedges to pick off a small fraction of the input beam. The incoming beam polarization state and irradiance are preserved.

MULTIPLES USES

- > Monitor power and beam profile simultaneously
- > Polarization insensitive beam-splitter with no back-reflections
- > Optical pick-off for use with our energy or power detectors
- > Attenuator for our high sensitivity detectors like M6 series and PH series

COMPATIBLE PRODUCTS



BEAMAGE-4M



BEAMAGE-4M-FOCUS
(for BA32-1KW only)



UP55N-40S-H9
(for BA32-1KW only)



PH series



M6 series

ACCESSORIES



BA32 mounting kit for
BEAMAGE-4M



BA32 mounting kit for
BEAMAGE-4M-FOCUS



BA32 mounting kit for
UP55N-40S-H9



	BA16-60S	BA16K-150S-H5-D0	BA16K-500F-H9-D0	BA32-1KW
MAXIMUM POWER	60 W	150 W	500 W	1000 W
EFFECTIVE APERTURE	16 mm ϕ	16 mm ϕ	16 mm ϕ	32 mm ϕ
COOLING METHOD	Convection	Convection	Fan	Water

MEASUREMENT CAPABILITY

Spectral range	200 - 2100 nm	200 - 2100 nm	200 - 2100 nm	200 - 2100 nm
Integrated power detector	N/A	UP19K-15S-H5-D0	UP19K-110F-H5-D0	Compatible with UP55 series (not included)
Fan input voltage	N/A	N/A	12 VDC	N/A
Equivalent attenuation	1/1700 @ 1064 nm	1/1700 @ 1064 nm	1/1700 @ 1064 nm	1/1900 @ 1064 nm
Optical wedges material	UV fused silica (uncoated)	UV fused silica (uncoated)	UV fused silica (uncoated)	UV fused silica (uncoated)
Residual beam deviation	5.6°	5.6°	5.6°	3.6° @ 1064 nm
Polarization correction	Yes (pair of orthogonal wedges)	Yes (pair of orthogonal wedges)	Yes (pair of orthogonal wedges)	Yes (pair of orthogonal wedges)

DAMAGE THRESHOLDS

Maximum power	60 W	150 W	500 W	1000 W
Maximum average power density	10 MW/cm ²	10 MW/cm ²	10 MW/cm ²	10 MW/cm ²
Maximum energy density	10 J/cm ²	10 J/cm ²	10 J/cm ²	10 J/cm ²

PHYSICAL CHARACTERISTICS

Aperture diameter	16 mm ϕ	16 mm ϕ	16 mm ϕ	32 mm ϕ
Dimensions	45H x 47W x 81D mm	54H x 50W x 91D mm	54H x 54H x 126D mm	145H x 250W x 132D mm
Weight	0.26 kg	0.37 kg	0.46 kg	5.5 kg
Mounting thread	SM1	SM1	SM1	SM2
Included adaptor	SM1 external threaded tube	SM1 external threaded tube	SM1 external threaded tube	N/A

ORDERING INFORMATION

Compatible Stand	STAND-S-233	STAND-S-233	STAND-S-233	2x STAND-S-443-C-M
Product Page				

POWER DETECTORS

ENERGY DETECTORS

BEAM PROFILING

TERAHERTZ DETECTORS

DISPLAYS & PC INTERFACES

CUSTOM / OEM PRODUCTS

UV CONVERTERS

Wavelength management



UV Converters take advantage of a phenomenon called fluorescence to extend the performance range of the Beamage beam profiling camera to ultraviolet wavelengths. A fluorescent crystal located at the entrance of the converter absorbs UV wavelengths and reemits longer wavelengths (in the visible spectrum), which are less energetic and detected by the CMOS sensor.

MAIN CHARACTERISTICS

- Transforms wavelengths contained between X-rays and 400 nm to visible and near-IR wavelengths.
- Images larger beams due to the magnification properties of the optics.
- Built with an iris at the output port for a control of the exposure on the CMOS sensor.
- Removable extension tube that is easily fixed onto the entrance port of the Beamage camera.
- Ready to use within minutes

SPECIFICATIONS

	BSF23C11.3N	BSF23P11.3N	BSF23R11.3N	BSF23G11.3N
Input Aperture \varnothing	23 mm	23 mm	23 mm	23 mm
Overall Length (OAL)	97 mm	97 mm	97 mm	97 mm
Magnification	1.4	1.4	1.4	1.4
Crystal Type	C	P	R	G
Wavelength range	110 - 225 nm	10 - 350 nm	110 - 532 nm	X-ray - 400 nm
Saturation level				
193 nm	400 mJ/cm ²	30 mJ/cm ²	50 mJ/cm ²	10 mJ/cm ²
248 nm	N/A	30 mJ/cm ²	400 mJ/cm ²	10 mJ/cm ²
308 nm	N/A	50 mJ/cm ²	400 mJ/cm ²	50 mJ/cm ²
Decay time	3 - 5 μ s	5 μ s	4000 μ s	0.1 μ s
Max repetition rate	20 - 30 kHz	20 kHz	25 Hz	20 kHz
Product page				

A complete procedure on how to choose the appropriate UV Converter (UV Converter Application Note) is available on our website at www.gentec-eo.com.

IR ADAPTOR

Wavelength management



Typically, a CMOS silicon sensor is operating at its full potential when imaging lasers with wavelengths between 350 nm and 1150 nm. If you want to extend the performance range of your Beamage beam profiling camera to the near-IR telecom wavelengths band, you can use the IR Adaptor. This ideal solution takes advantage of a multi-photon absorption process to extend the sensitivity range of the camera sensor to a portion of the near-IR spectrum (1495 nm - 1595 nm).

MAIN CHARACTERISTICS

- Converts wavelengths between 1495 nm and 1595 nm to shorter wavelengths between 950 nm and 1075 nm.
- Images larger beams due to the convergent properties of the optics (3.29X).
- Built with a high quality coated anti-reflection input window that allows wavelength conversion with low distortion and maximum image resolution.
- Removable and easily C-mounted onto the entrance port of the camera.
- Ready to use within minutes.

SPECIFICATIONS

IR ADAPTOR	
Active area	27.5 mm \varnothing
IR spectral range	1495 nm - 1595 nm
Peak IR sensitivity	1510 nm and 1540 nm
Converted wavelengths	950 nm - 1075 nm
Pixel Multiplication Factor	3.29
Minimum beam size	230 μ m
Maximum beam size	19 mm
Maximum resolution	12 lp/mm over active area 40 lp/mm at sensor focal plane
Distortion	-1.0% barrel distortion (inverted image)
Linearity	Non-Linear, IR converted output \sim IR input intensity ¹⁴¹
Spectral transmission	360 nm - 2000 nm at F30.8
Damage threshold	1 W/cm ²
Dimensions	46 mm \varnothing x 97 mm L
Operating temperature	-10°C to +40°C
Weight	210 g
Product page	

EXCITATION SPECTRUM

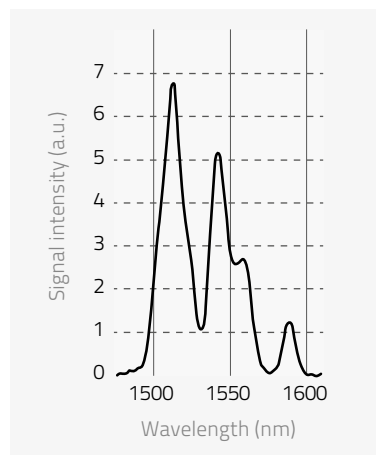

FILTERS

Wavelength management

UV BANDPASS FILTER

We also offer a color glass filter specially designed for the UV spectrum. Depending on the wavelength, the UG11-UV filter transmits 20% to 70% of the input beam power. It is particularly useful for applications with wavelengths contained between 250 nm and 370 nm. Other wavelengths are blocked by the filter. The UG11-UV is SM1 threaded and comes with a SM1 to C-mount adaptor.

SPECIFICATIONS

MODEL	UG11-UV
Spectral range	250 nm - 370 nm
Diameter	25 mm \varnothing
Clear aperture	80% of area
Dimensional tolerance	+0.0 / -0.2 mm
Thickness	3 mm
Thickness tolerance	+0.0 / -0.2 mm
Parallelism	< 3 arcmin
Surface flatness	< $\lambda/4$
Maximum power	1 W
Surface quality	40 - 20 Scratch-Dig
Damage threshold	30 W/cm ² (typical)
Product page	

* Data specified at 633 nm

SPECTRAL TRANSMISSION

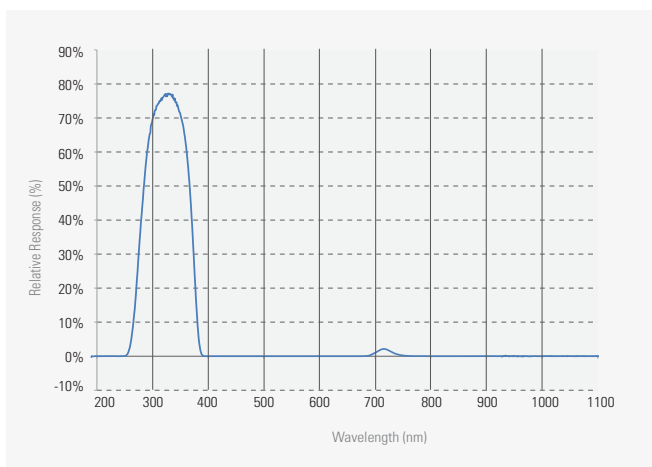

IR FILTER

The B3-IR-FILTER is a color glass filter specifically designed for IR applications. Acting as a longpass filter, the B3-IR-FILTER cuts all the wavelengths below 1250 nm and only lets the IR wavelengths pass. It transmits approximately 70% of the incident light. The B3-IR-FILTER is SM1 threaded and comes with a SM1 to C-mount adaptor so you can mount it on the Beamage camera.

SPECIFICATIONS

MODEL	B3-IR-FILTER
Spectral range	1250 - 1350 nm
Diameter	25 mm \varnothing
Clear aperture	80% of area
Dimensional tolerance	+0.0/-0.2 mm
Thickness	6.3 mm max
Parallelism	< 3 arcmin
Surface flatness	< $\lambda/4$
Maximum power	1 W
Surface quality	80-50 Scratch-Dig
Damage threshold	30 W/cm ² (Typical)
Product page	

SPECTRAL TRANSMISSION

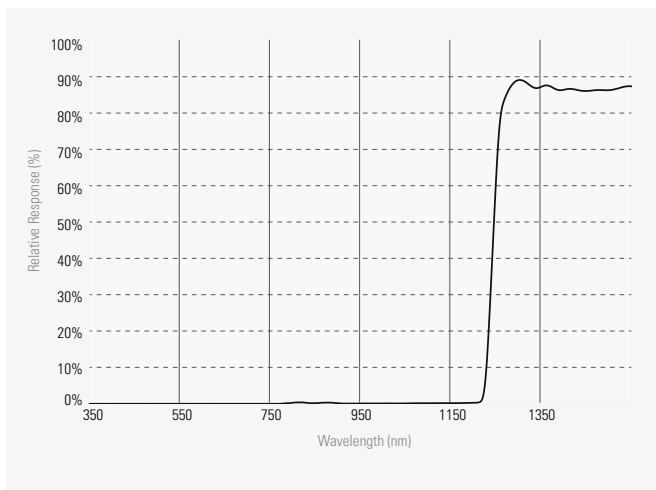

CAMERA LENSES

Camera lenses work by indirectly imaging on the sensor the reflection or the transmission of a beam that previously went through a diffusing material such as glass (see diagrams below).

It is necessary to use a camera lens to image beams that are larger than the CMOS sensor (11.3 mm X 11.3 mm) of the Beamage beam profiling camera. A camera lens can be directly C-mounted onto the aperture of the Beamage camera.



SPECIFICATIONS

	CL-25	CL-50
Focal length	25 mm	50 mm
Horizontal FOV	14°	7°
FOV at 1m	245 mm	120 mm
Minimum working distance	0.5 m	1 m
Maximum beam size	2000 mm X 2000 mm (not a limiting factor)	2000 mm X 2000 mm (not a limiting factor)
Maximum measurable intensity / energy	Very high because of indirect mechanism	Very high because of indirect mechanism
Inverted image	Yes	Yes
Beam distortion	Setup, lens aberration and speckles from diffusing glass	Setup, lens aberration and speckles from diffusing glass
Diffusing material needed	Yes	Yes
Magnification calibration needed	Yes	Yes
Possibility of wavelength conversion	Yes	Yes
Optical filter needed	Rarely to never	Rarely to never
Removable	Yes	Yes
Product page		

IMAGING A TRANSMITTED BEAM

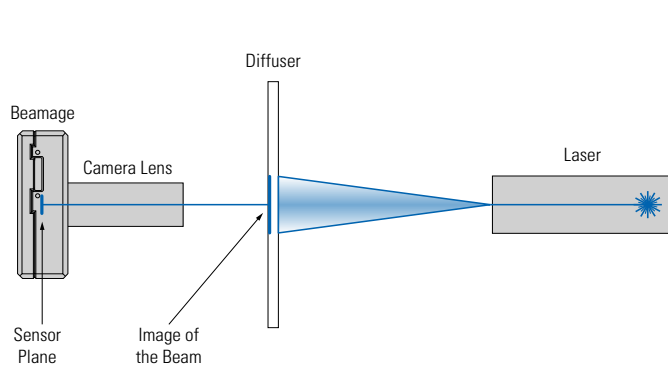

IMAGING A REFLECTED BEAM

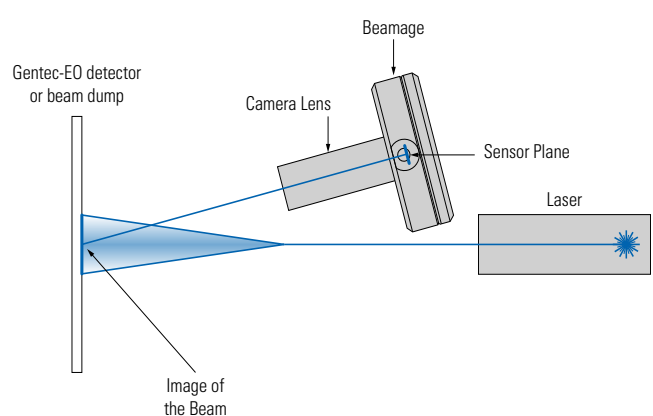

ABSORPTION CURVES

Specifications

Beamage relative response

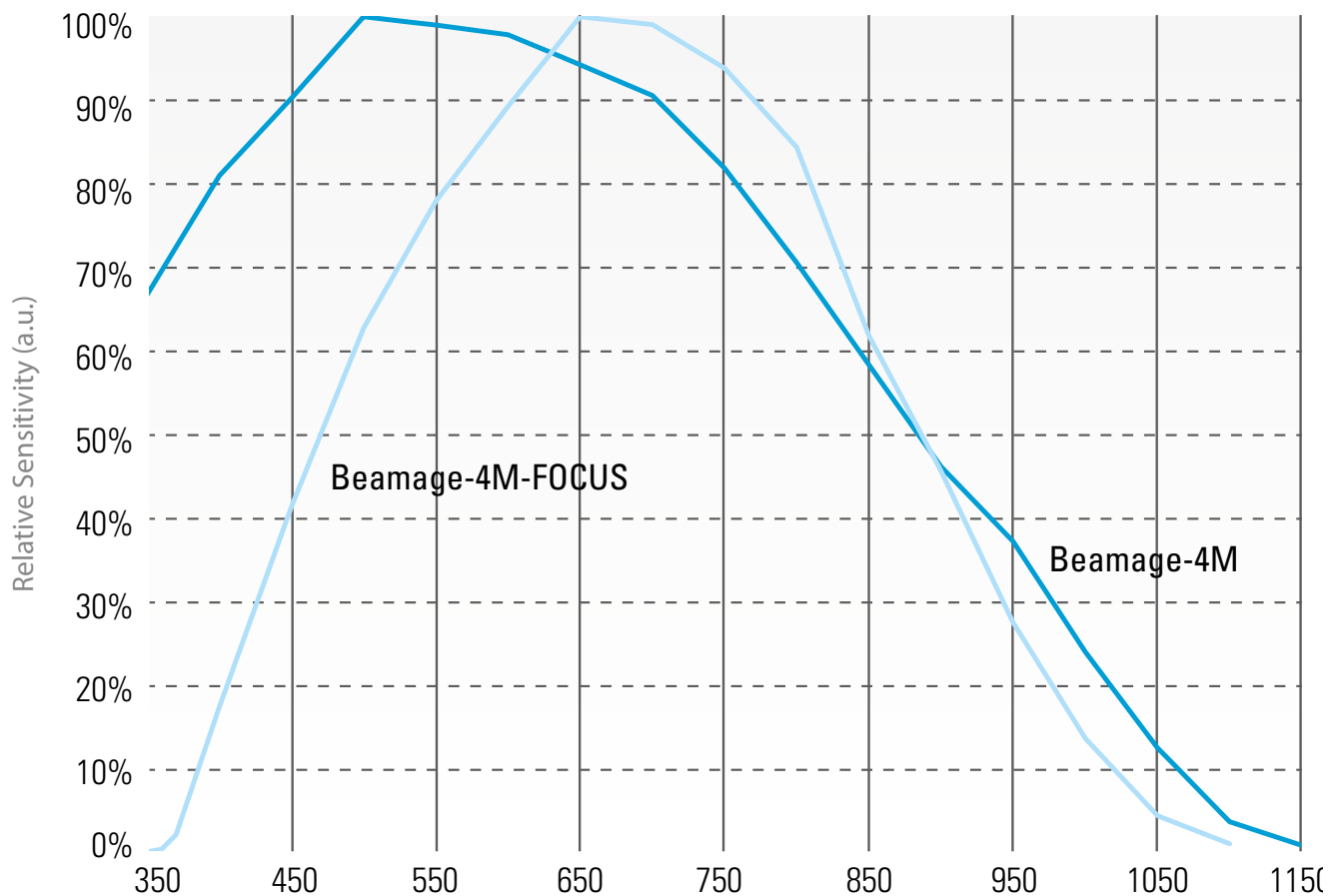

ABSORPTION CURVES

Specifications

Beamage operating range

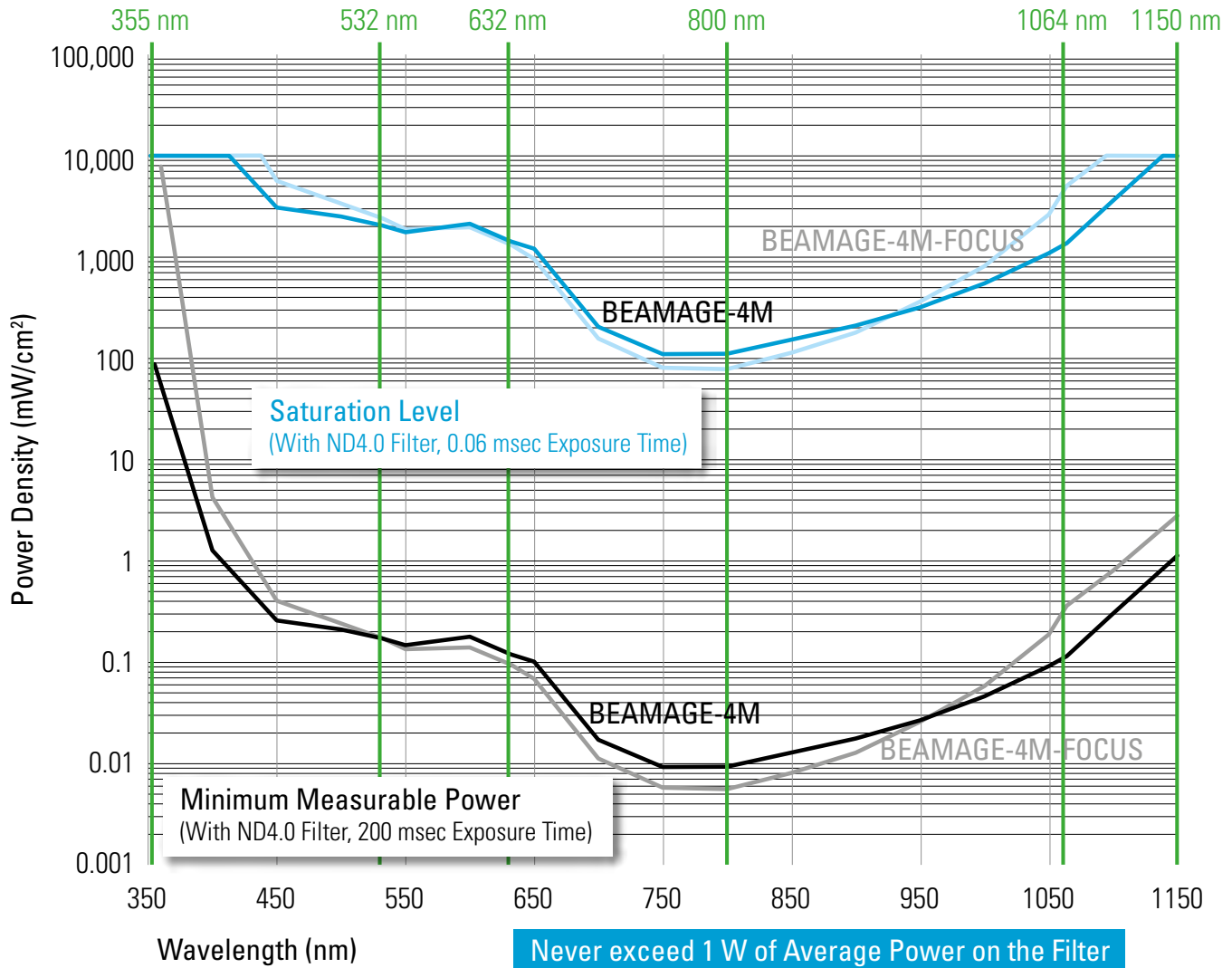

TERAHERTZ DETECTORS

Overview of the different models

WHAT IS TERAHERTZ RADIATION?

The THz portion of the electromagnetic spectrum fills the gap between the far infrared and the microwaves. More precisely, it is nestled between the high-frequency edge of the microwave band, 300 GHz (3×10^{11} Hz), and the long-wavelength edge of far-infrared light, 3000 GHz (3×10^{12} Hz or 3 THz). In wavelengths, this range corresponds to 0.1 mm (or 100 μm) infrared to 1.0 mm microwave. The THz band is set in the region where electromagnetic physics can best be described by its wave-like characteristics (microwave) and its particle-like characteristics (infrared).

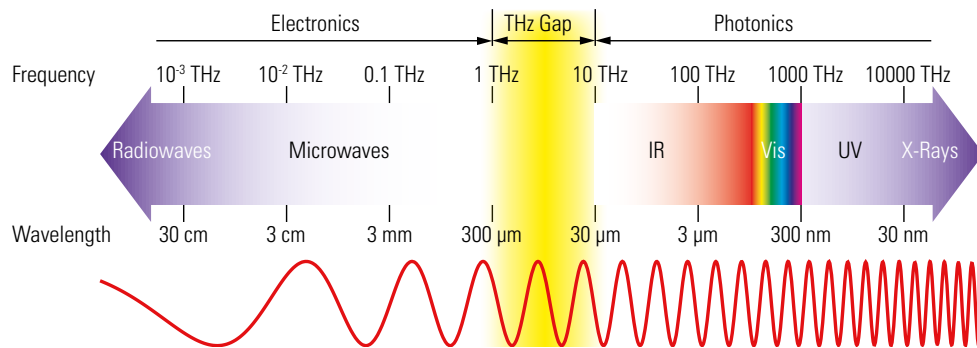

WHAT IS IT USED FOR?

THz radiation is interesting because of the way it interacts with matter:

- It can penetrate things like wood, plastics, clothing, and other materials.
- It is also absorbed by water, or a material that contains water, like human skin.
- It is non-ionizing and therefore not harmful to humans like X-rays can be.

One of the first uses is the "full body scan" used at airports. It also has uses in medical applications for early detection of cancer cells.

HOW IS IT MEASURED?

THz sources range in power from nW to mW and in energy from nJ to mJ. Like most electromagnetic sources, they must be characterized for performance and/or control.

Older THz detection methods include:

- Golay cells
- Microbolometers
- Electronic antennas

Newer THz detection methods include:

- Pyroelectric detectors
- Schottky diode detectors
- Photoacoustic detectors

WHY ARE GENTEC-EO PRODUCTS BETTER?

Golay cells are large, fragile, costly and have a limited measurement range.

Pyroelectric detectors (like the ones used in our THz detectors) are small, sensitive, durable and less costly. Some of their advantages are:

- High performance in a small package
- Broad spectral response (from 0.25 to 3000 μm)
- Wide dynamic range (from nW to mW)
- Rugged and durable
- Very cost-effective

TERAHERTZ DETECTORS

Overview of the different models

We have a unique line of sensors and meters for the terahertz region. You can choose either a standalone device with on-board electronics or go with our T-Rad meter and a separate sensor. We also have small terahertz detectors that come as discrete pyroelectric units for integration.



THZ-B

- Large apertures: 5 mm and 9 mm \varnothing
- Wide dynamic range: 10 nW to 20 mW
- Choice between analog and digital versions
- User-friendly software (when used with the T-Rad module)

■ WORKS WITH OUR T-RAD AND T-RAD-ANALOG MODULES



THZ-I-BNC

- Sensitive 5-mm detector integrated with low-noise amplifier
- Wide dynamic range from nW to μ W
- Battery or AC powered
- Compatible with an oscilloscope or lock-in amplifier

■ INTEGRATED BNC MODULE



THZ-D

- Flat spectral response: Get the best precision across the entire THz range
- Works with our standard universal displays & PC interfaces.
- Large apertures of 9 and 12 mm \varnothing

■ FLATEST SPECTRAL RESPONSE IN THE THZ

■ WORKS WITH OUR STANDARD DISPLAYS & PC INTERFACES

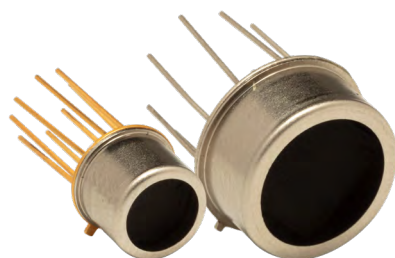

QS-THZ

- Easily integrated into a THz measurement instrument or set-up
- Small TO5/TO8 packages
- Available in 2 sizes: 5 and 9 mm \varnothing apertures
- Wide dynamic range from nW to mW
- Plug-and-play with QS-I-TEST evaluation test box

■ DISCRETE PYROELECTRIC DETECTORS

THZ-B

THz-B detectors and T-Rad modules



KEY FEATURES

- > **COVERS THE ENTIRE THZ SPECTRUM**
Get the best precision across the entire wavelength range and relative measurements from 30 THz to 0.1 THz.
- > **ROOM TEMPERATURE OPERATION**
Easier to use and less expensive than a Goly cell.
- > **MEASURE POWER FROM nW TO mW**
With state of the art pyroelectric sensors, measure down to 10 nW with 1 nW NEP
- > **USE WITH T-RAD THZ MODULE OR T-RAD-ANALOG POWER MODULE**
Each head can be connected to an oscilloscope using the analog power module (T-Rad-Analog) or directly to a PC with the digital power module (T-Rad)
- > **SEVERAL SENSOR SIZES AVAILABLE**
Choice of 5 mm and 9 mm diameter
- > **CALIBRATED AT 0.63 μm**
All THz detectors are calibrated at a single wavelength (0.63 μm) and include a typical wavelength correction data from 0.25 to 440 μm . They are used for relative measurements outside that range.
- > **SDC-500 OPTICAL CHOPPER**
All THz-B detectors require the use of an optical chopper, like our SDC-500, to sync the signal at either 5 Hz (DA models) or 25 Hz (DZ models)

OUTPUT OPTIONS

- > **SMART DB15 CONNECTOR**
Contains all the calibration data
- > **TWO DETECTOR TYPES AVAILABLE:**
 - "DZ": digital output, used with T-RAD digital power module
 - "DA": analog output, used with T-RAD-ANALOG analog power module

COMPATIBLE DISPLAYS & PC INTERFACES



T-RAD
(for "-DZ" models only)



T-RAD-ANALOG
(for "-DA" models only)

ACCESSORIES



Stand with delrin post



Removable IR windows
(Various types available)



SDC-500 digital
optical chopper



Winston cone



Pelican carrying case



	THZ5B-BL-DZ	THZ5B-BL-DA	THZ9B-BL-DZ	THZ9B-BL-DA
MAX AVERAGE POWER	20 mW	25 μ W	20 mW	125 μ W
EFFECTIVE APERTURE	5 mm \emptyset	5 mm \emptyset	9 mm \emptyset	9 mm \emptyset
COMPATIBLE MODULES	T-Rad	T-RAD-ANALOG	T-Rad	T-RAD-ANALOG

MEASUREMENT CAPABILITY

Spectral range ^a				
Frequency	0.1 - 30 THz	0.1 - 30 THz	0.1 - 30 THz	0.1 - 30 THz
Wavelength	3000 - 10 μ m	3000 - 10 μ m	3000 - 10 μ m	3000 - 10 μ m
Max measurable power	20 mW	25 μ W	20 mW	125 μ W
Noise equivalent power (NEP)	5 nW	1 nW	50 nW	3 nW
Rise time (0-95%)	\leq 0.2s	\leq 0.2s	\leq 0.2s	\leq 0.2s
Sensitivity (Typical)	N/A	140 kV/W	N/A	20 kV/W
Chopping frequency ^b	25 Hz	5 Hz	25 Hz	5 Hz

DAMAGE THRESHOLDS

Max average power density (at 1064 nm)	10 mW/cm ²	10 mW/cm ²	10 mW/cm ²	10 mW/cm ²
---	-----------------------	-----------------------	-----------------------	-----------------------

PHYSICAL CHARACTERISTICS

Effective aperture	5 mm \emptyset	5 mm \emptyset	9 mm \emptyset	9 mm \emptyset
Sensor	Pyroelectric	Pyroelectric	Pyroelectric	Pyroelectric
Absorber	BL	BL	BL	BL
Dimensions	66.0 \emptyset x 46.5D mm	66.0 \emptyset x 46.5D mm	66.0 \emptyset x 46.5D mm	66.0 \emptyset x 46.5D mm
Weight	227 g	227 g	227 g	227 g

ORDERING INFORMATION

Compatible stand	STAND-D-233	STAND-D-233	STAND-D-233	STAND-D-233
Product page				

- a. Projected spectral range.
From 10 to 440 μ m, spectrometer measurement.
From 440 to 3000 μ m, relative measurement only.
This spectral range is subject to change.
- b. SDC-500 digital optical chopper sold separately.



T-Rad
(rear view)



T-Rad-Analog
(front view)



T-Rad

The T-Rad is a microprocessor-based digital radiometer that includes a 12-bit ADC and unique DSP Lock-In Software. It is powered by a USB connection, which also acts as a Virtual COM port. When a THZ-B Terahertz Pyroelectric detector is plugged into the T-Rad module, the module reads the content of the head's EEPROM, which identifies the detector and provides calibration and wavelength correction data. The LabVIEW Software supplied with the device makes it very easy to set up the radiometer, measure a THz or broadband source and record data. The software is compatible with Windows 7, 8 & 10.

SPECIFICATIONS & FEATURES

	T-RAD	T-RAD-ANALOG
Compatible detector heads	THZ-B-DZ	THZ-B-DA
Full scale ranges	200 nW - 200 mW*	N/A
Power on light	Green	Green
Analog output	0 to 3.6V, BNC	± 4.88 V, BNC
PC connection	USB 2.0	None
Trigger input (TTL)	BNC connector	None
Power supply	USB 2.0	External, 100/240 VAC 50 - 60 Hz, and 9V battery (both included)
Product number	201849	202306

* Actual ranges vary based on the THZ-B detector selected

INSTRUMENT CONTROL AND STRIP CHART

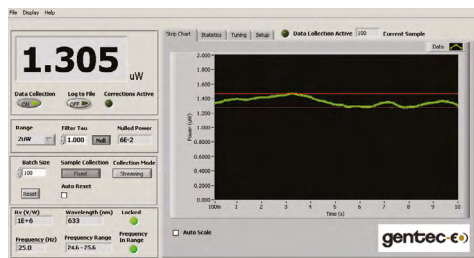

Instrument controls and the radiant power measurement are always visible, making it easy to change the radiometer settings, no matter which display tab is selected. Instrument controls include: Range, Filter Tau, Batch Size, Data Collection Mode, Reset Options, and a Null button for background cancellation. In addition, there are more set up and operation status indicators including: detector Rv, Wavelength, Frequency (actual), Locked and Frequency in Range lights. The Strip Chart displays the Radiant Power measurement in Watts, either continuously or by the batch. Select full scale, auto scale or use our manual scaling option.

INSTRUMENT CONTROL AND TUNING NEEDLE

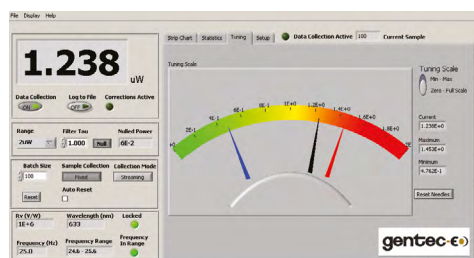

The "TUNE" tab selects the very useful "Tuning Needle" display. This is a simulated analog meter whose speed is determined by the "filter tau" setting. It is expected to be used during the set-up of a radiometer with a source. The "tau" value is usually set to a small value when aligning the probe to the source (i.e. when peaking the reading). There is a button control to select "full scale", "min-max" or "reset". In the "min-max" mode, the indicators are "blue" for the minimum power and "red" for the maximum power.



INSTRUMENT CONTROL AND STATISTICS

In the "Statistics" tab there are 4 large windows that contain the statistics for the selected batch, including: Minimum, Maximum, Standard Deviation and Mean, expressed in Engineering Notation. Standard Deviation can be displayed in Watts or as a % that is user-selectable. There is also a window that shows the bandwidth of the Digital Band Pass Filter based on the user selected "Filter Tau" (0.100 to 100 seconds). A lower time constant is helpful when setting up, and a longer one when making measurements, especially on the lower ranges of the instrument.

THZ-B-DA DETECTOR AND OSCILLOSCOPE

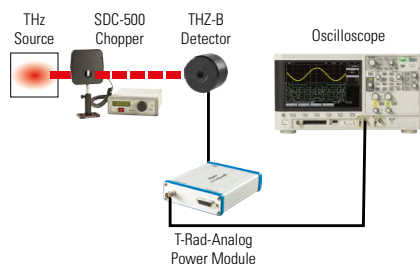

Here is a basic analog set up that would be useful if the optical power of the source was about $5 \mu\text{W}$ or greater. The output of the THZ5B-BL-DA detector would be approximately 600 mV at 5 Hz chopping frequency, giving plenty of signal for an oscilloscope. Simply read the voltage output and divide by the R_v factor (V/W) of the detector to measure the intensity of the source in Watts. Also consider applying a wavelength correction factor under certain circumstances.

THZ-B-DA DETECTOR AND LOCK-IN AMPLIFIER

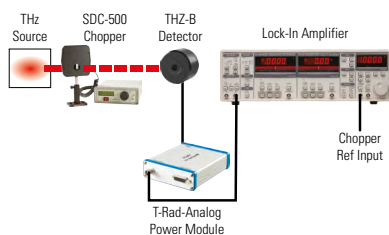

This is another analog set-up option that we recommend if you have to measure very low power levels (i.e. less than $5 \mu\text{W}$) where the signal may be buried in the broadband noise. The voltage output of the analog THZ-B-DA detector, powered by our T-Rad-Analog, is routed to the Lock-In Amplifier input, and the Sync Output of our SDC-500 Chopper is connected to the reference input. The Lock-In Amplifier will lock on the chopping frequency and you can dial in a long integrating time and measure a very low RMS voltage. The voltage divided by our Voltage Responsivity (V/W) equals the power of the source.

THZ-B-DZ DETECTOR AND T-Rad MODULE

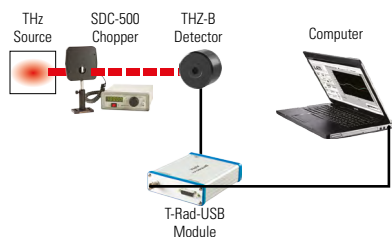

Although analog solutions are available, for simplicity, convenience and sensitivity, we recommend you choose our THZ-B-DZ detectors and the T-Rad Digital Radiometer. Our unique DSP Lock-In Amplifier software provides a function much like the Analog Lock-In, but is so much easier to use. It also addresses thermal drift of the sensor and allows you to display the power measurement and complete statistics directly in digital and graphic formats. Set the range, null the background, set the filter tau (bandwidth) and make the measurement. It's that easy!

THZ-I-BNC

THz detectors with integrated analog module



KEY FEATURES

- > **COVERS THE ENTIRE THZ SPECTRUM**
Measure accurately from 0.25 to 15 μm and from 30 THz to 0.1 THz in relative terms
- > **MEASURE POWER FROM nW TO μW**
Make low-level measurements with an NEP of 1.0 nW
- > **MEASURE ENERGY FROM nJ TO μJ**
Can be used with low repetition rate pulsed THz sources to measure pulse energy up to 40 Hz
- > **INTEGRATED ANALOG MODULE**
Plug the device directly into your oscilloscope or Lock-In Amplifier
- > **BATTERY OR EXTERNAL POWER**
Includes 9V battery and an external power supply
- > **CALIBRATED AT 0.63 μm**
All THz detectors are calibrated at a single wavelength (0.63 μm) and include typical wavelength correction data from 0.25 to 440 μm . They are used for relative measurements outside that range.
- > **SDC-500 OPTICAL CHOPPER**
The THZ-I-BNC models require the use of an optical chopper, like our SDC-500, running at 5 Hz.

OUTPUT OPTIONS

- > **ANALOG OUTPUT**
Plug the device directly into your oscilloscope or lock-in amplifier with the BNC output

ACCESSORIES



Stand with delrin post



Removable IR Windows
(Various types available)



SDC-500 digital
optical chopper



Pelican carrying case

THZ-I-BNC

Specifications



*Also traceable to NRC-CNRC



THZ51-BL-BNC	
MAX AVERAGE POWER	62.5 μ W
EFFECTIVE APERTURE	5 mm \varnothing
INTEGRATED MODULE	Analog (BNC)

MEASUREMENT CAPABILITY

Spectral range ^a	
Frequency	0.1 - 30 THz
Wavelength	3000 - 10 μ m
Max measurable power	62.5 μ W
Noise equivalent power ^b	1.0 nW
Rise time (0-100%)	\leq 0.2s
Sensitivity (Typical)	140 kV/W
Chopping frequency	5 Hz (Required)
Calibration uncertainty	Contact us
Energy mode	
Maximum measurable energy	2 μ J
Noise equivalent energy	1.0 nJ
Minimum pulse width	1.0 μ s
Maximum repetition rate	40 Hz

DAMAGE THRESHOLDS

Maximum average power density (1064 nm)	50 mW/cm ²
--	-----------------------

PHYSICAL CHARACTERISTICS

Effective aperture	5 mm \varnothing
Sensor	Pyroelectric
Absorber	BL
Analog output	0-10 V
Dimensions	81.3 \varnothing X 99.3D mm
Weight	500 g

ORDERING INFORMATION

Compatible stand	STAND-D-233
-------------------------	-------------

Product page



- a. Projected spectral range.
 From 10 to 440 μ m, spectrometer measurement.
 From 440 to 3000 μ m, relative measurement only.
 This spectral range is subject to change.
- b. At 632 nm and a chopping frequency of 5Hz.

POWER DETECTORS

ENERGY DETECTORS

BEAM PROFILING

TERAHERTZ DETECTORS

DISPLAYS & PC INTERFACES

CUSTOM / OEM PRODUCTS

THZ-D

THz detectors for use with our universal displays & PC interfaces



KEY FEATURES

- > **COVERS THE ENTIRE THZ SPECTRUM**
Get the best precision across the entire wavelength range and relative measurements from 30 THz to 0.1 THz.
- > **ROOM TEMPERATURE OPERATION**
Easier to use and less expensive than a Golay cell.
- > **CALIBRATED AT 10.6 μm**
THZ-D detectors are calibrated at a single wavelength 10.6 μm (30 THz) and at 10 Hz chopping frequency for the THZ9D. Both include typical wavelength correction data from 10.6 to 440 μm . They are used for relative measurements outside that range.
- > **LARGE AREA**
Models range from 9 mm \varnothing for the THZ9D and 12 mm \varnothing for the THZ12D.
- > **WIDE RANGE OF MEASUREMENTS**
Measure from 100 μW to 3 W of continuous power with the THZ12D model, the highest in our terahertz range of products, and down to 5 μW to 25 mW with the THZ9D model.
- > **USE WITH A UNIVERSAL DISPLAYS & PC INTERFACE**
No need for an exclusive monitor. These unique THz detectors work with our display & PC interface.
- > **SDC-500 OPTICAL CHOPPER**
The THZ9D model requires the use of an optical chopper, like our SDC-500, running at 10 Hz.

OUTPUT OPTIONS

- > **SMART DB15 CONNECTOR**
Contains all the calibration data
- > **ANALOG OUTPUT**
When used with APM (D) analog power supply module
- > **integra ALL-IN-ONE-METER** (for THZ12D only)
Connects directly to a PC
Two models available:
 - USB output (-INT)
 - RS-232 output (-IDR)

COMPATIBLE DISPLAYS & PC INTERFACES



MIRO ALTITUDE



MAESTRO



U-LINK



M-LINK



APM (D)
analog power module
(for THZ9D)

ACCESSORIES



Stand with steel post
(for THZ12D)



Stand with delrin
(for THZ9D)



SDC-500 digital
optical chopper



Pelican carrying case



Extension cables
(4, 15, 20 or 25 m)





Extra isolation tube



Fiber adaptors & connectors
(FC, ST and SMA)



	THZ9D-20mS-BL	THZ12D-3S-VP
MAX AVERAGE POWER	25 mW	3 W
EFFECTIVE APERTURE	9 mm \varnothing	12 mm \varnothing
COMPATIBLE DISPLAYS & PC INTERFACES	MIRO ALTITUDE, MAESTRO, U-LINK, M-LINK & APM (D)	MIRO ALTITUDE, MAESTRO, U-LINK & M-LINK
MEASUREMENT CAPABILITY		
Spectral range ^a		
Frequency	0.1 - 30 THz	0.1 - 30 THz
Wavelength	3000 - 10 μ m	3000 - 10 μ m
Maximum average power		
with MAESTRO	20 mW	3 W
with U-LINK, M-LINK or MIRO ALTITUDE	25 mW	3 W
Noise equivalent power ^b	300 nW	0.5 μ W
Minimum measurable power ^c	N/A	50 - 100 μ W
Thermal drift	N/A	12 μ W/ $^{\circ}$ C
Rise time (nominal) ^d	< 0.2 s	3 s
Minimum repetition rate ^f	1000 Hz	7 Hz
Chopping frequency	10 Hz (required)	N/A
Calibration uncertainty ^g	\pm 5.0% at 10.6 μ m; \pm 15% at 10.6 - 440 μ m ^a	\pm 3.0% at 10.6 μ m \pm 8.0% at 10.6 - 300 μ m \pm 15% at 300 - 440 μ m
Repeatability	\pm 0.5%	\pm 0.5%
DAMAGE THRESHOLDS		
Maximum average power density ^h	50 mW/cm ²	30 W/cm ²
Maximum energy density	< 0.1 J/cm ²	< 1 J/cm ²
PHYSICAL CHARACTERISTICS		
Effective aperture	9 mm \varnothing	12 mm \varnothing
Absorber	BL (Black Absorber)	VP (Volume Absorber)
Dimensions	38.1 \varnothing x 79 mm	73H x 73W x 20D mm (72D mm with tube)
Weight (head only)	91 g	320 g
ORDERING INFORMATION		
Compatible stand	STAND-D-233 or STAND-D-233-M	STAND-D-233 or STAND-D-233-M
Product page		

a. From 10 to 440 μ m, spectrometer measurement with multiple laser references validation.
From 440 to 600 μ m, spectrometer measurement only.
From 600 to 3000 μ m, relative measurement only.
This spectral range is subject to change.

b. Nominal value, actual value depends on electrical noise in the measurement system.

c. Actual value depends on ambient conditions and the measurement system.

d. With anticipation

e. Maximum output voltage = sensitivity x maximum power.

f. Minimum repetition rate for stable average power measurements.

g. Including linearity with power.

h. At 1064 nm, 1 W CW.

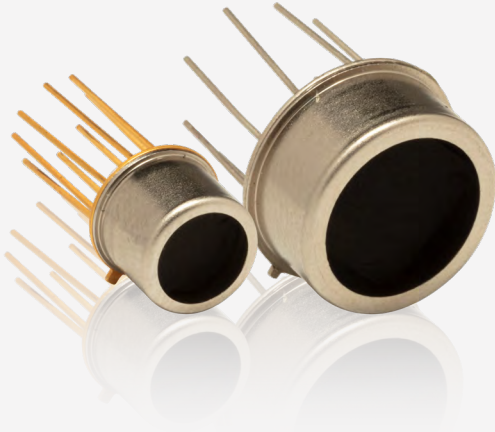

* Pictures for indicative purposes only

KEY FEATURES

- **RELATIVE MEASUREMENTS FROM 0.1 TO 30 THZ**
Broadband, room temperature operation, easier to use and less expensive than a Golay cell
- **EASY TO INTEGRATE FORMAT**
TO5 and TO8 packages make the QS-THZ detectors small and easy to integrate in an existing system
- **SEVERAL SENSOR SIZES AVAILABLE**
Choice of 5 and 9 mm Ø
- **CALIBRATED AT 0.63 µm**
All THz detectors are calibrated at a single wavelength (0.63 µm) and include a typical wavelength correction data from 0.25 to 440 µm. They are used for relative measurements outside that range.
- **TEST BOX AVAILABLE**
Can be used with our QS-I-TEST test box which provides mounting and power supply

PERMANENT IR WINDOW OPTIONS

Every model can be fitted with a permanent IR window to narrow the wavelength range:

- S5/8: sapphire (0.3 - 4.5 and 100 - 1000 µm)
- Q5/8: quartz (0.25 - 3.0 and 50 - 1000 µm)
- Si5/8: silicon (1.2 - 8.0 and 50 - 1000 µm)

ACCESSORIES



QS-I-Test
evaluation test box



Permanent IR Windows
(Various types available)



SDC-500 digital
optical chopper



Pelican carrying case



	QS5-THZ-BL	QS9-THZ-BL
VOLTAGE RESPONSIVITY	120 kV/W	30 kV/W
EFFECTIVE APERTURE	5 mm ϕ	9 mm ϕ
PACKAGE	TO5	TO8



MEASUREMENT CAPABILITY

Spectral range ^a		
Frequency	0.1 - 30 THz	0.1 - 30 THz
Wavelength	3000 - 10 μ m	3000 - 10 μ m
Max power density	50 mW/cm ²	50 mW/cm ²
Noise equivalent power	1 nW	3 nW
Detectivity ^b	4.10 ⁸ cm(Hz) ^{1/2} /W	2.7.10 ⁸ cm(Hz) ^{1/2} /W
Voltage responsivity ^b	120 kV/W	30 kV/W

PHYSICAL CHARACTERISTICS

Effective aperture	5 mm ϕ	9 mm ϕ
Package	TO5	TO8
Sensor	Pyroelectric	Pyroelectric
Absorber	BL	BL
Dimensions (excluding pins)	9.1 ϕ x 6.4D mm	15.2 ϕ x 6.4D mm
Weight	45 g	45 g

ORDERING INFORMATION

Product page		
---------------------	---	--

- a. Projected Spectral Range.
From 10 to 440 μ m, spectrometer measurement.
From 440 to 3000 μ m, relative measurement only.
This spectral range is subject to change.
- b. 630 nm, 5 Hz



QS-I-TEST EVALUATION TEST BOX

	QS-I-TEST
Batteries	+9V/-9V
R_t resistors	105 - 1010 Ω
C_t compensating	YES
Package	101.6H x 127W x 58.4D
Optical mount	1/4"-20 threaded
Front bezel	SM1 (1.035-40)
Product number	201693

* For details, contact your Gentec-EO representative

Specifications are subject to change without notice

ABSORPTION CURVES

Specifications

VP ABSORBER

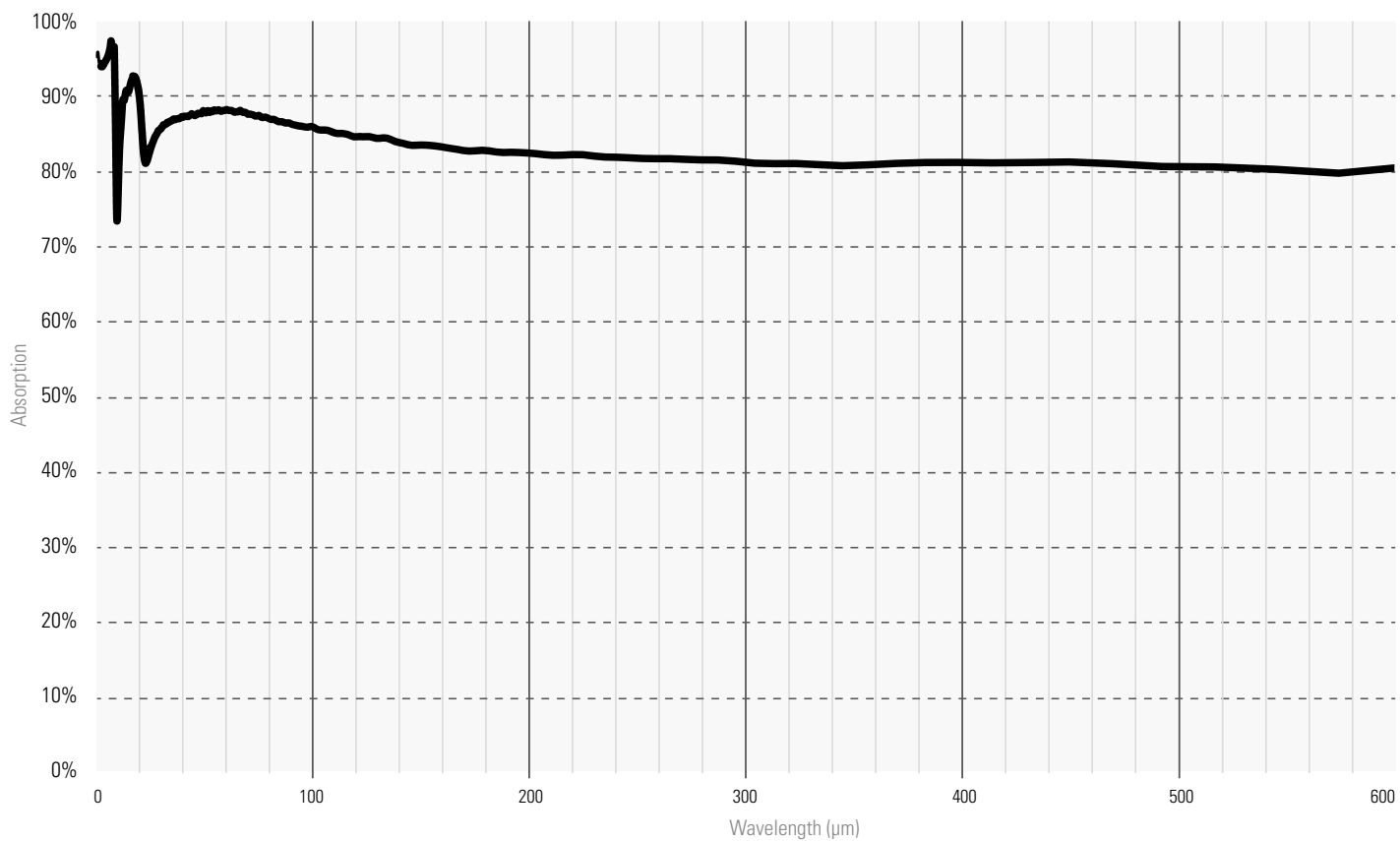

ABSORPTION CURVES

Specifications

THZ-BL, THZ-I-BL & QS-THZ-BL

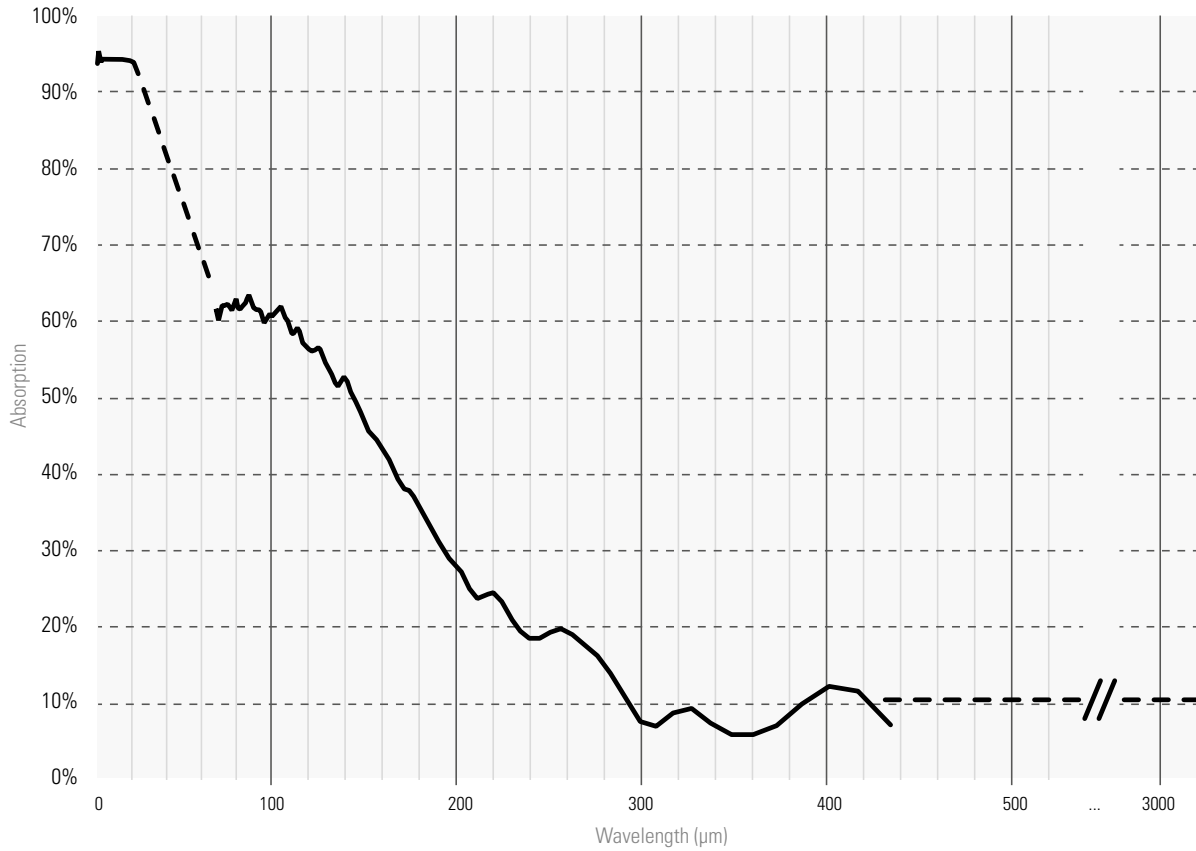

POWER DETECTORS

ENERGY DETECTORS

BEAM PROFILING

TERAHERTZ DETECTORS

DISPLAYS & PC INTERFACES

CUSTOM / OEM PRODUCTS

DISPLAYS & PC INTERFACES

Overview of the display modules

We offer four models of meters with display: MIRO ALTITUDE and MAESTRO for both power and energy measurements, as well as TUNER and UNO for power readings. Connect one of these display devices to your detector and you have a complete laser power or energy measurement system



MIRO ALTITUDE

MIRO ALTITUDE is Gentec-EO's flagship product for reading laser power and energy. It was designed to help engineers and service technicians increase their productivity thanks to numerous innovative features in both hardware and software. Enter modern times of laser beam measurement with MIRO ALTITUDE.

Supercharge your productivity with an intuitive user interface, an extra large screen, tons of connectivity possibilities, 3 convenient display modes, a built-in dataviewer and a built-in file manager.

■ PROFESSIONAL LASER POWER & ENERGY METER



MAESTRO

The MAESTRO power & energy meter is our top of the line display device with an extra-large 5.6 in color LCD display and fully touchscreen controls. With its unique user interface and faster electronics, it will do more, in less time, and with less effort than any other meter on the market!

■ LASER POWER & ENERGY METER



TUNER

The TUNER power meter display presents both a large LCD display and an ultrafast needle. It also features min and max holds for both displays, comet tail needle and bar graph function. The TUNER comes in Gentec-EO's ergonomic design, with a large LCD display and easy to use direct access keys.

■ ULTRA-FAST TUNING NEEDLE



UNO

The UNO is a simple power meter display, with large contrast fields and direct access buttons. Its extremely low power consumption allows it to work on standard alkaline batteries, making it the display of choice for service technicians working in the field. With the lowest price for a display meter, the UNO is the perfect choice when looking for a reliable, entry-level power meter.

■ ECONOMICAL POWER METER

DISPLAYS & PC INTERFACES

Overview of the PC interfaces

The Gentec-EO PC interfaces come in various sizes and types to cover all applications. We offer models for power or energy measurement, or both. Most of our PC interfaces are single-channel, and we also offer models with either 2 channels or even up to 4 channels.



LINK SERIES

The U-LINK, P-LINK, S-LINK and M-LINK are PC interfaces for our power or energy detectors and are provided with free software applications.

- U-LINK is a universal power & energy meter that measures ALL detectors in our product range up to 10 kHz repetition rate. It has a very small footprint.
- P-LINK is a small power meter, available with either a USB or RS-232 connector. A 4 Channel version is also available.
- S-LINK comes with 1 or 2 channels and measures energy detectors at a very fast rate. It comes with a USB connector, Ethernet also available in option.
- M-LINK is a universal power & energy meter that measures ALL detectors in our product range and features a unique noise suppression method.

■ PC-BASED POWER OR ENERGY METERS

DISPLAY DEVICES



	MIRO ALTIUDE	MAESTRO	TUNER	UNO
Detector Compatibility				
Power measurement	UP, XLP, PH, HP, UM-B, THZ-D	UP, XLP, PH, HP, UM-B, THZ-D	UP, XLP, PH & HP	UP, XLP, PH & HP
Energy measurement	QE, PE, also UP & XLP in SSE mode	QE, PE, also UP & XLP in SSE mode	N/A	N/A
Display	10in touchscreen	5.6in touchscreen	3.8in LCD, backlit	3.8in LCD
Output	2xUSB, USB-C, RS-232, Ethernet	USB, RS-232, Ethernet, analog output	Analog output	N/A
Data logging	Internal memory and USB key	USB key	N/A	N/A
External trigger	Yes	Yes	N/A	N/A
Number of channels	1	1	1	1

PC INTERFACES



	U-LINK	P-LINK	S-LINK	M-LINK
Detector Compatibility				
Power measurement	UP, XLP, PH, UM-B, THZ-D	UP, XLP & PH	UP & XLP	UP, XLP, PH, UM-B, THZ-D
Energy measurement	QE, PE, also UP & XLP in SSE mode	UP & XLP in SSE mode	QE, PE, also UP & XLP in SSE mode	QE, PE, also UP & XLP in SSE mode
Output	USB, analog output & sync. out. RS-232 available on certain models	USB & analog output. RS-232 available on certain models	USB & Ethernet	USB & analog output
External trigger	Yes	N/A	Yes	Yes
Maximum repetition rate	10 kHz/channel	N/A	10 kHz/channel	1 kHz
Number of channels	1	1 or 4, depending on model	1 or 2, depending on model	1

Specifications are subject to change without notice

DISPLAYS & PC INTERFACES

Overview of the PC interfaces



PC INTERFACES

While the vast majority of Gentec-EO detector heads are compatible with the U-LINK and S-LINK PC interfaces, a few of our specialized detectors require different data processing methods. In this case, we offer dedicated PC interfaces that are optimized for these measurements.

- HIGH-PERFORMANCE ELECTRONICS FOR SPECIALIZED MEASUREMENTS

DEDICATED PC INTERFACES



	T-RAD	T-RAD-ANALOG	QUAD-4TRACK	MACH 6	APM (D)
Detector Compatibility					
Power measurement	THZ-B series (-DZ models)	THZ-B series (-DA models)	QUAD-P series	N/A	UM-B series & THZ9D
Energy measurement	N/A	N/A	QUAD-E series	M6 series	M6 (with adaptor), QE-B & PE-B series
Output	USB & analog output	Analog output	USB & analog output	USB & analog output	Analog output
External trigger	Yes	Yes	Yes	Yes	N/A
Maximum repetition rate	N/A	N/A	1 kHz	200 kHz	Depends on the detector
Number of channels	1	1	4 (1 detector)	1	1

ALL-IN-ONE DETECTORS

Overview of the different models

We also offer displays and PC interfaces which are integrated with the detector head. We offer four families of these all-in-one detectors. INTEGRA features either a USB or RS-232 output for a direct connection to your PC. BLU is available for all our thermal power detectors and allows you to view and log power measurements on your mobile device or PC. PRONTO includes a display, so you have everything you need in a single, portable device.



INTEGRA

The INTEGRA version of our standard laser power or energy detectors allows you to read your measurements directly on your PC thanks to our free software.

Simply carry your all-in-one detector and plug it in your PC any time you need to measure your laser power or energy. No need to buy a separate meter!

- USB LASER POWER OR ENERGY METER



BLU

Our thermal power detectors (UP and HP series) are available in their BLU version, which allows you to read your power measurement directly on your mobile phone or PC thanks to Bluetooth connectivity.

You get the same high accuracy measurements without the need to connect any wires or to carry a separate acquisition & readout device. This solution is not only more practical, but also more economical compared to our other laser power measurement systems.

- WIRELESS LASER POWER METER



PRONTO

Our PRONTO series is of high interest for those who need a laser measurement system that is portable and compact. These products can be handheld (for low power only) or placed on a stand like our standard detectors.

These user-friendly products are so simple to use that anyone can start using them within seconds. They all offer data logging on their internal memory. Data can then be transferred to your PC via USB.

- PORTABLE, ALL-IN-ONE LASER POWER METERS



HP

Our HP series of high power detectors include internal signal processing and two data output options: USB to read and log measurements with your computer, or DB15 to use a Gentec-EO display such as MAESTRO.

If you prefer going wireless, the HP detectors are also available with the BLU option.

- ALL-IN-ONE SOLUTIONS FOR HIGH POWER MEASUREMENT

MIRO ALTITUDE

Touchscreen, single-channel, laser power & energy meter

New product



KEY FEATURES

- **READS ALL HEADS**
Power: thermopiles, photodetectors and pyroelectrics
Energy: thermopiles (in SSE mode), photodetectors and pyroelectrics
- **LARGE TOUCHSCREEN DISPLAY**
10in diagonal
1280 x 800 resolution
Touchscreen controls
- **INTUITIVE USER INTERFACE**
Easy to navigate interface, with 3 display modes: scope, needle and bar chart.
Instant access to the detector settings
- **REAL-TIME STATISTICAL FUNCTIONS**
Max, min, average, standard deviation, RMS and PTP stability, and repetition rate
- **MULTIPLE OUTPUTS**
Multiple USB ports for computer connection and charging (1x USB-C, 2x USB-A), BNC analog output (coming soon), RS-232, Ethernet, programmable I/O (coming soon)

CONNECTIVITY

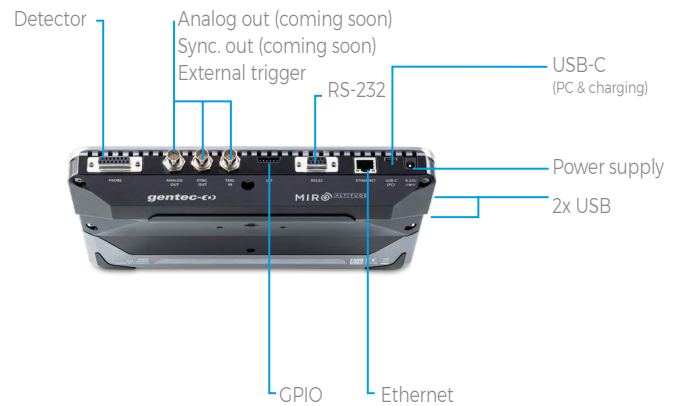

ACCESSORIES



MIRO ALTITUDE

Specifications



MIRO ALTITUDE	
DETECTOR TYPES	ALL MODELS: thermopiles, pyroelectrics, photodetectors
DISPLAY	10" high-resolution, anti-glare, touchscreen
POWER METER SPECIFICATIONS	
Power range	4 pW to 150 kW
Meter accuracy	±0.5% ± 3 μV from 20% to full scale
Statistics	Current value, max, min, average, standard deviation, RMS & PTP stability, time
ENERGY METER SPECIFICATIONS	
Energy range	2 fJ to 30 kJ
Meter accuracy	1.0% ± 50 μV (< 500 Hz) 2.0% ± 50 μV (500 Hz to 10 kHz)
Software trigger level	0.1 to 99.9%, 0.1% resolution, default 2%
Repetition rate	10 kHz for data acquisition in real time with time stamp, no missing point
Statistics	Current value, max, min, average, std dev., RMS & PTP stability, pulse #, rep. rate and average power
DETECTOR COMPATIBILITY	
Thermopile	Average power & single shot energy
Photodetector	Average power & pulse energy
Pyroelectric	Average power & pulse energy
GENERAL SPECIFICATIONS	
Digital display size	10.1-inch diagonal LCD - 1280 x 800 pixels
Outputs	Analog out, 0 - 5 V (BNC) (coming soon) Sync out (BNC) (coming soon) RS-232 (DB9) Ethernet (RJ45) USB-C 2x USB-A
Rising edge external trigger	3.3-24 V (BNC)
Serial commands via	USB-C, RS-232 or Ethernet
Data storage via	Internal memory or USB key
Battery type	Rechargeable Li-ion cell
Battery life	6 hours
External power supply	12 VDC power supply included, or UBS-C (min 18 W)
PHYSICAL CHARACTERISTICS	
Mounting holes	1/4"-20 and 2x10-32 threaded holes
Dimensions	268W x 196H x 36D mm
Weight	1.36 kg
ORDERING INFORMATION	
Compatible stand	STAND-R-443
Product page	

POWER DETECTORS

ENERGY DETECTORS

BEAM PROFILING

TERAHERTZ DETECTORS

DISPLAYS & PC INTERFACES

CUSTOM / OEM PRODUCTS

MIRO ALTITUDE

Main screen

Access the control center

Take a screenshot

Start a data-logging session

Display battery level

Display time











1 NAVIGATION BAR

The upper part of the screen includes a direct access to the control center, data acquisition buttons and various indicators (battery level and time).

2 MEASUREMENT SETTINGS PANEL

Use the various measurement settings available for your detector to set everything related to your measurement.

-  **Wavelength:** Enter your wavelength or choose from a list of recently used wavelengths
-  **Range:** Set the measuring range to autoscale or to one of the standard values
-  **Measurement mode:** Choose what you want to measure: power, SSE, moving average, etc.
-  **Moving average:** Choose the desired moving average to use to plot the chart
-  **Trigger:** Enter the desired trigger level or choose from a list of recently used values
-  **XNR Anticipation™:** Toggle on to measure up to 10x-20x faster without losing any significant accuracy in your readings
-  **Correction:** Set a multiplier and an offset value for your measurements
-  **Attenuator:** Toggle when using a Gentec-EO calibrated attenuator with your detector

3 DISPLAY AREA

The top part of the display area is the same for all three display modes.



CLEAR

Clear: Use this button to reset the statistics and erase the scope graph's data



Display mode: Toggle your display mode between: scope, needle and bar chart



ZERO

Zero: Set the current measured value to zero

MIRO ALTITUDE

Display modes

SCOPE DISPLAY

With this display mode, you can travel in time using the time line at the bottom to view measurements at any point in time while MIRO ALTITUDE continues to measure.

The dotted blue line shows the average value.

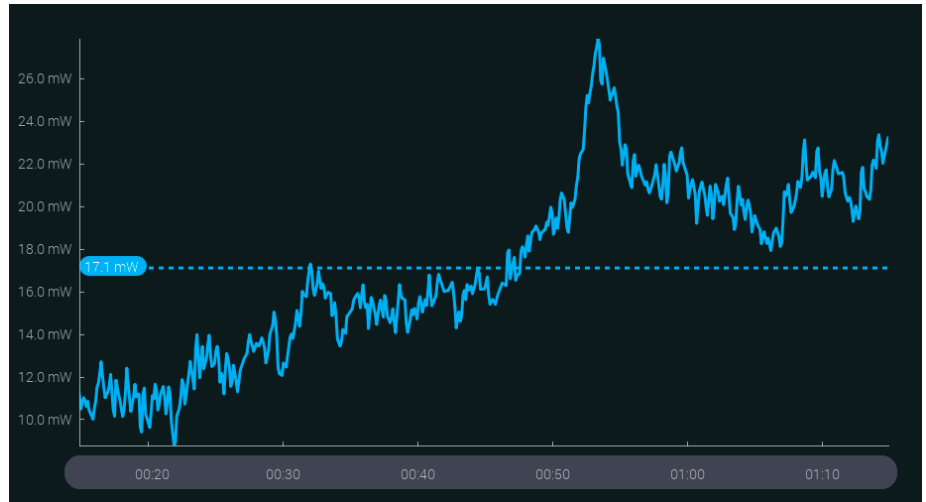

NEEDLE DISPLAY

Faster than an analog needle thanks to XNR Anticipation™! This mode is particularly useful when tuning a laser. The real-time value and statistics are always visible at the top of the screen.

Arrows indicate the minimum and maximum measured values since the last reset. The zoom function sets these values as full scale of the digital gauge.

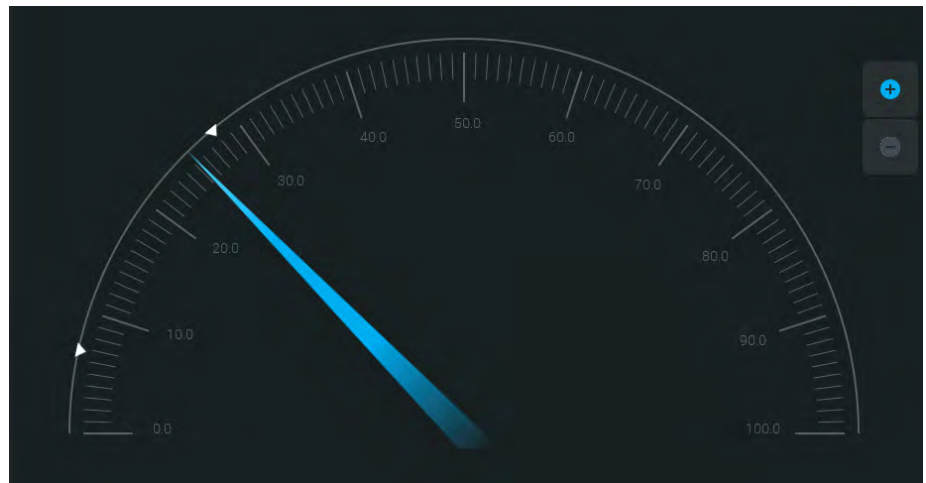

BAR DISPLAY

This is the simplest display mode. Its main advantage is that the current measured value is displayed in huge size, allowing you to read the measurement from a good distance.

Arrows indicate the minimum and maximum measured values.

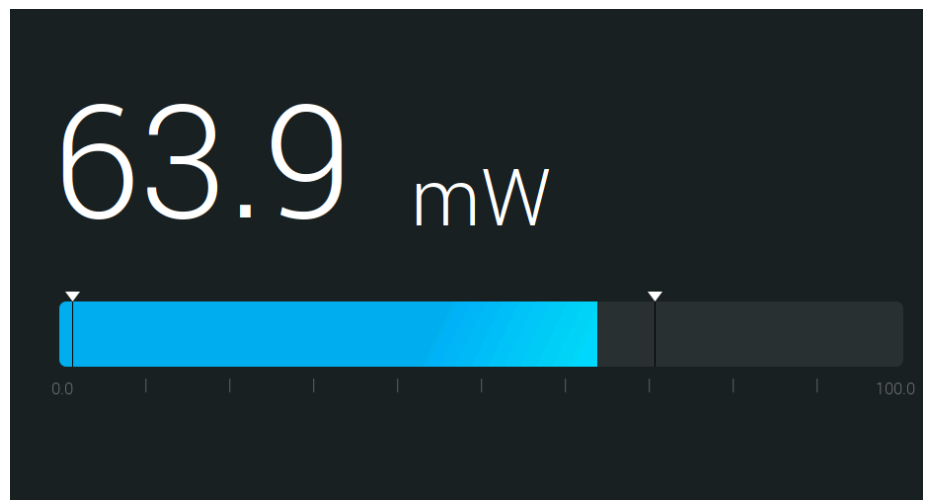

POWER DETECTORS

ENERGY DETECTORS

BEAM PROFILING

TERAHERTZ DETECTORS

DISPLAYS & PC INTERFACES

CUSTOM / OEM PRODUCTS

MIRO ALTITUDE

Settings & controls

BUILT-IN FILE MANAGER AND DATA VIEWER

MIRO's built-in file manager lets you access and organize all your screenshots and recorded measurement sessions. You can also copy files on your USB key.



Visualize a recorded measurement session with our built-in data viewer. Data will be displayed in the scope chart display.

There is also a built-in image viewer so you can view your screenshots directly on your MIRO ALTITUDE.

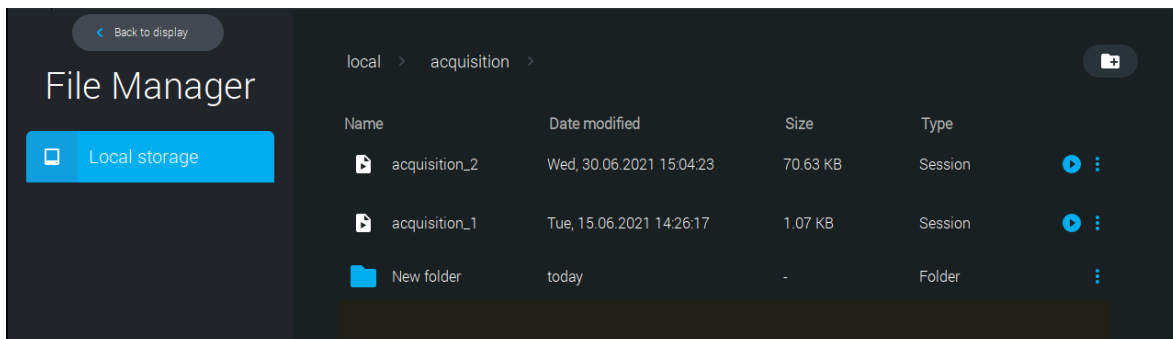

CONTROL CENTER

The control center is accessible from all screens in the top left corner.

Easily navigate between the main screens of the app:



Display



File manager







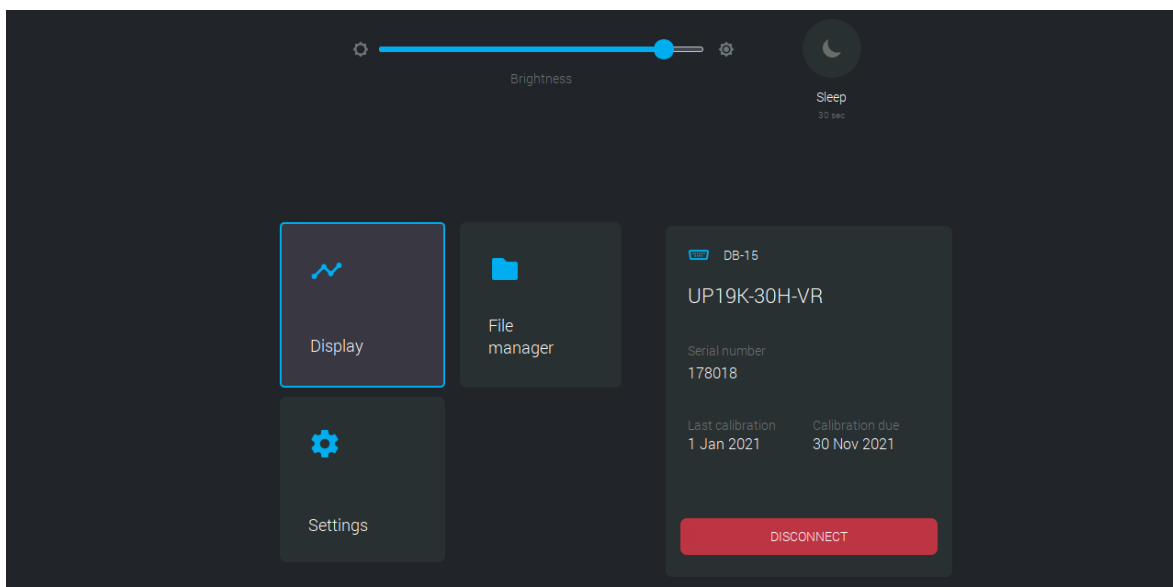

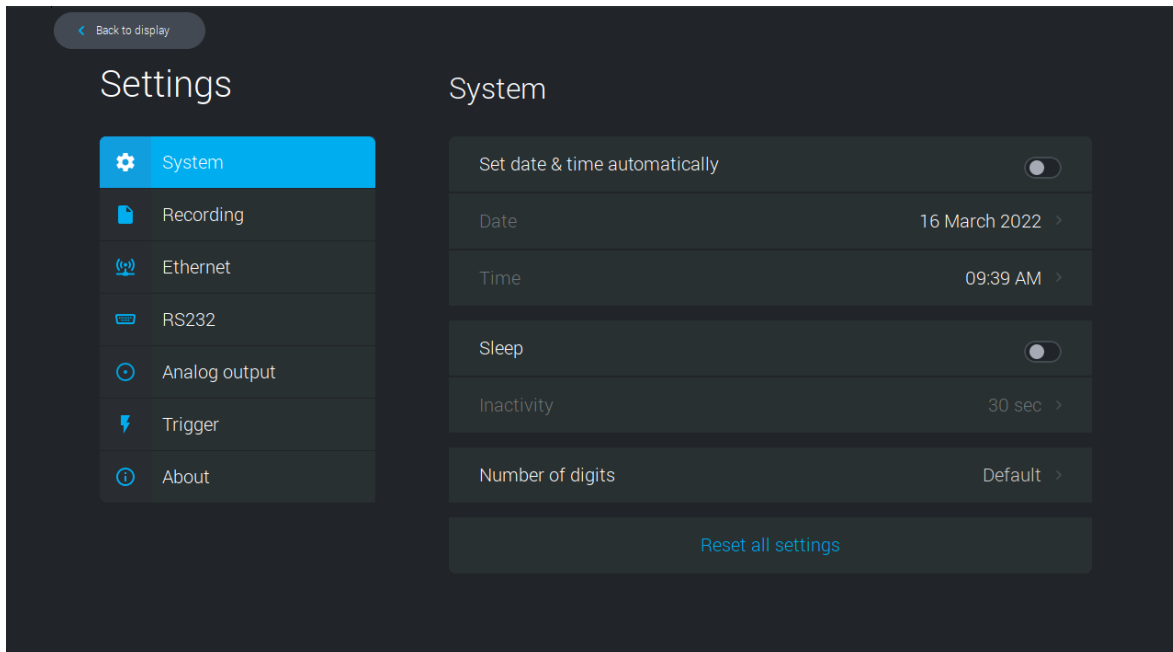

Settings for the device.

Connect/disconnect your Gentec-EO detector to MIRO ALTITUDE



DEVICE SETTINGS



-  **System:** Set device settings: language, date, time, sleep, number of digits, etc.
-  **Recording:** Set your default recording parameters for power/energy measurement and destination.
-  **Ethernet:** Set your Ethernet parameters or let MIRO manage this automatically.
-  **RS-232:** Set your RS-232 parameters.
-  **Analog output:** Set your analog output parameters. (coming soon)
-  **Trigger:** Use an external trigger and set your trigger level.
-  **About:** View important information about your device (serial number, firmware version, software version, calibration date) and find support.

MAESTRO

Touchscreen, single channel, power & energy monitor

MULTIPLE LANGUAGES



KEY FEATURES

> READS ALL HEADS

- Power: thermopiles, photodetectors and pyroelectrics
- Energy: thermopiles (in single shot mode), photodetectors and pyroelectrics

> LARGE TOUCHSCREEN COLOR LCD DISPLAY

- 5.6in diagonal
- FULLY touchscreen controls

> UNIQUE ERGONOMIC DESIGN

Great for both handheld and tabletop use, with improved rubber bands and kickstand for better stability

> INTUITIVE USER INTERFACE

Easy to navigate interface, with many display features:

- Single or dual graph display
- Instant access to the main functions
- Function search tool
- Interface available in multiple languages

> USB KEY ACCESS

Store data directly on a USB key

> REAL-TIME STATISTICAL FUNCTIONS

Max, min, average, standard deviation, RMS and PTP stability, pulse # and repetition rate

> AVAILABLE OUTPUTS

USB Key, analog output, RS-232, PC-USB, Ethernet

CONNECTIVITY

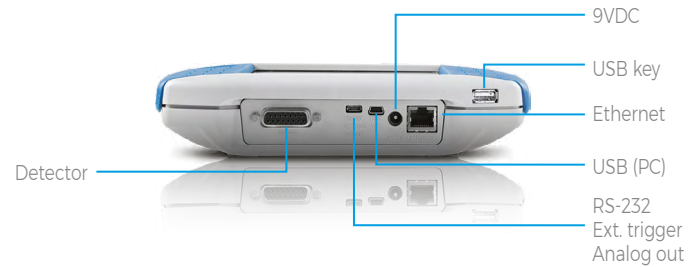

ACCESSORIES



Additional 9V power supply



Battery pack



USB, RS-232, external trigger & analog out cables



Pelican carrying case



MAESTRO

DETECTOR TYPES	ALL MODELS: thermopiles, pyroelectrics, photodetectors
DISPLAY	Touchscreen 5.6 in color LCD
POWER METER SPECIFICATIONS	
Power Range	
Thermopile	1 μ W to 30 kW
Photodetector	4 pW to 3 W
Monitor accuracy	0.25% \pm 5 μ V best scale
Statistics	Current value, max, min, average, standard deviation, RMS & PTP stability, time

ENERGY METER SPECIFICATIONS	
Energy range	2 fJ to 30 kJ
Monitor accuracy	\pm 1% best scale
Software trigger level	0.1 to 99.9%, 0.1% resolution, default 2%
Repetition rate	2000 Hz / 10 000 Hz in sampling
Real-time data transfer (To USB key)	2000 Hz
Statistics	Current value, max, min, average, std dev., RMS & PTP stability, pulse #, rep. rate and avg power

DETECTOR COMPATIBILITY	
Thermopile	Average power & single shot energy
Photodetector	Average power & pulse energy
Pyroelectric	Pulse energy & average power

GENERAL SPECIFICATIONS	
Interface languages	English, German, French and Japanese
Digital display size	112.9 x 84.7 mm LCD - 640 x 480 pixels
Data display	Real-time, scope, statistics, digital tuning needle and averaging
Analog output	0-1 Volt, full scale, \pm 0.5%
Rising edge external trigger	TTL compatible, 2-25 V at 0.4 mA
Serial commands via	USB (standard), Ethernet or RS-232 (cable in option)
Data storage via	USB key
Dimensions	210W x 122H x 45D mm
Weight (with batteries)	0.67 kg
Battery type	4 x rechargeable 1.2 V Ni-MH AA
Battery life	6.5 hours
External power supply	100/240 VAC 50 - 60 Hz to 9 VDC 1.66 A

ORDERING INFORMATION	
Product page	

MAESTRO

Specifications



HOME

- Set Device: Set all the parameters related to your MAESTRO device.
- Set Measure: Set all the parameters related to your sensor.
- Display: Set the device in dual or full screen display mode and choose the display(s) you want.
- Acquisition: Set all your acquisition parameters (time, sample rate, etc.).
- Startup Config: Choose how your MAESTRO will remember your sensor settings at startup.
- About: View the main parameters and update your MAESTRO.



SET DEVICE

- Use the elements in this menu to set the parameters related to your MAESTRO:
- Number of Digits: Use this menu to set the precision of the measurement.
- Serial Commands: Set compatibility with SOLO2 and use the RS-232, USB and analog outputs
- Ethernet: Configure the Ethernet communication protocol.
- Languages: Select the display language: English, German, Japanese or French
- Recalibrate touchscreen: Recalibrate your touchscreen by following the simple step-by-step procedure

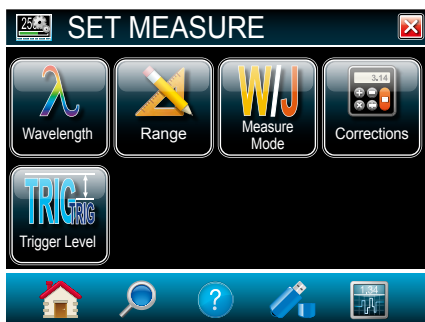

SET MEASURE

- Use the elements in this menu to set everything related to your measurements:
- Wavelength: Select one of the standard wavelengths offered, or enter a custom value and create your own list of standard wavelengths.
- Range: Set the measuring range to autoscale or a fixed scale.
- Measure Mode: Use this menu to decide what type of measurements will be displayed: average power, single shot energy, pulse-to-pulse energy, etc.
- Corrections: Enter multipliers and offsets.
- Trigger Level: Set the trigger level in 0.1% steps, from 0.1% and 99.9%.



DUAL SCREEN DISPLAY (SHOWN WITH SCOPE DISPLAY)

Any display mode can be used in both single or dual display mode. In dual display mode, the Real-Time display takes the upper portion of the screen, while any of the other displays (Scope, Needle, Averaging or Statistics) is set on the lower portion. The display in the lower portion can be easily changed using the parameters bar with drop-down menus in the center of the screen. You can also expand one of the displays to have it in Full Screen mode using the maximize button. Just as easily, you can go back to Dual Screen display by using the minimize button.

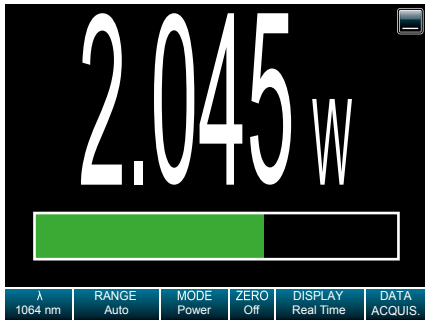

REAL-TIME DISPLAY

This display shows the measured value in real time, with a corresponding bar graph below. The large size of the digits and high contrast of the graphics allow to see the measurement from a good distance. This mode is also always present in dual screen mode, in the upper portion of the screen.

- Very large digits
- Bar graph

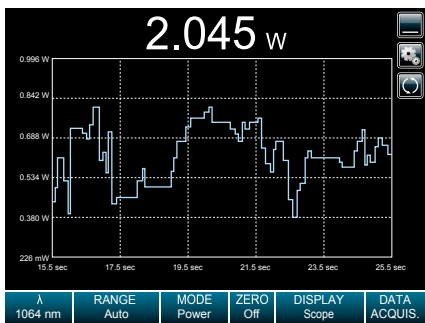

SCOPE DISPLAY

With its line filling from the right of the screen, in a first-in/first-out manner, this display mode is a good approximation of an actual oscilloscope reading. Settings include time (x-axis) and range (y-axis). Basic statistics can also be displayed directly on the screen.

- Oscilloscope-type graph
- On-screen, real-time statistics (min, max and average)
- Fully customizable x and y axis



NEEDLE DISPLAY

Exactly like an analog needle, only faster! This mode is particularly useful when tuning a laser. The Real-time value is also displayed at the top of the screen.

- Ultra-fast readings
- Great for tuning
- Real-time value at the top of the screen
- Min and Max Values hold

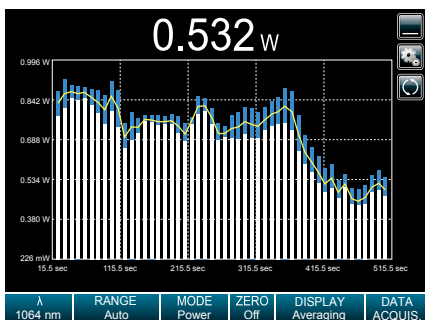

AVERAGING DISPLAY

This very unique mode is perfect to show the trend of a laser over time. Set the number of points per batch and let the MAESTRO identify the minimum and maximum values of every batch. A yellow curve then follows the average of each batch, displayed as bars on the screen. The wider the difference between the white and blue portions of a bar (corresponding to the min and max values), the more unstable your laser is.

- Calculates the min, max and average values of batches of measurements
- Perfect to check laser stability over time

TUNER

Single Channel, Power Monitor with Tuning Needle



KEY FEATURES

- > **ULTRA-FAST NEEDLE**
Less than 1 second response time
- > **READS ALL POWER DETECTORS**
Thermopiles and photodetectors of the PH100 and PH20 Series
- > **LARGE LCD DISPLAY**
 - 77 x 58 mm
 - 17.5 mm digits
 - Backlight (with AC adaptor)
- > **3 DISPLAY FUNCTIONS FOR THE NEEDLE**
 - Normal
 - Tail Mode (indicates speed)
 - Bar graphAlso HIGH and LOW values hold
- > **SINGLE-BUTTON NAVIGATION**
Direct access and long press access to the main functions
- > **LOW CONSUMPTION**
Lasts 500 hours with 4 AA alkaline batteries

DISPLAY MODE

- > **TAIL:**
Follows the speed of the power change. The comet tail is longer for faster reading changes and shorter for slower reading changes.
- > **BAR GRAPH:**
Fills the needle display up to the real-time value (best mode when viewing from a distance).
- > **HIGH/LOW:**
When activated, indicates the highest and lowest powers since activation. The high and low needles blink to help distinguish them from the real-time value.



ACCESSORIES



Additional 9V power supply



Wall support



Pelican carrying case



TUNER

DETECTOR TYPES	Thermopiles, photodetectors (PH series)
DISPLAY	LCD with tuning needle and backlight

POWER METER SPECIFICATIONS

Power range	10 pW to 10 kW
Digital resolution	
PH series	10 pW
XLP series	1 μ W
UP series	1 mW
HP series	100 mW (HP60A), 1 W (HP100A)
Monitor accuracy	$\pm 1\%$, full scale
Statistics	Min, max
Response time	< 1 s

DETECTOR COMPATIBILITY

Thermopiles	Average power (W, dBm)
Photodetectors (PH series)	Average power (W, dBm)

GENERAL SPECIFICATIONS

Digital display size	77 x 58 mm LCD
Needle display	Ultrafast tuning needle
Needle accuracy	0.9%
Refresh rate	4 Hz
Analog output	0-1 Volt, full scale, $\pm 1\%$
Dimensions (without stand)	210W x 122H x 44D mm
Weight (with batteries)	0.47 kg
Battery type	4 x AA alkaline
Battery life (estimated)	500 hours with detector
External power supply	100/240 VAC 50 - 60 Hz to 9 VDC 1.66 A

ORDERING INFORMATION

Product page



POWER DETECTORS

ENERGY DETECTORS

BEAM PROFILING

TERAHERTZ DETECTORS

DISPLAYS & PC INTERFACES

CUSTOM / OEM PRODUCTS

UNO

Single channel, power monitor



KEY FEATURES

- > **READS ALL POWER DETECTORS**
Thermopiles and photodetectors of the PH Series
- > **LARGE LCD DISPLAY**
 - 76 x 57 mm
 - 32 mm digits
- > **UNIQUE ERGONOMIC DESIGN**
Great for both handheld and tabletop use
- > **ACCURATE**
24 bit A/D converter for high resolution measurements
- > **SINGLE-BUTTON NAVIGATION**
Direct access and long press access to all the functions
- > **EXTREMELY LOW CONSUMPTION**
Lasts 670 hours with 4 AA alkaline batteries
- > **ECONOMICAL**
Get the best value for your money with this inexpensive and simple to use power monitor

NOW AVAILABLE

W/dBm

You can toggle your display between Watts or dBm units

ACCESSORIES



Optional 9V power supply



Wall support



Pelican carrying case



UNO

DETECTOR TYPES	Thermopiles, photodetectors (PH series)
DISPLAY	LCD

POWER METER SPECIFICATIONS

Power range	10 nW to 10 kW
Thermopile	Single wide range scale
Photodetector	Autoscale
Digital resolution	
PH series	1 pW
XLP series	1 μ W
UP series	1 mW
Monitor accuracy	$\pm 1\%$
Response time	1 s

DETECTOR COMPATIBILITY

Thermopiles	Average power (W, dBm)
Photodetectors	Average power (W, dBm)

GENERAL SPECIFICATIONS

Digital display size	76 x 57 mm LCD
Digit height	32 mm
Digit type	High contrast fields
Data display	Real-time
Dimensions (without stand)	210W x 122H x 44D mm
Weight (with batteries)	0.47 kg
Battery type	4 x AA alkaline
Battery life (estimated)	670 hours with detector
External power supply (optional)	100/240 VAC 50 - 60 Hz to 9 VDC 1.66 A

ORDERING INFORMATION

Product page	
---------------------	---

U-LINK

Single channel, PC-based universal power and energy monitor



KEY FEATURES

> THE UNIVERSAL PC-BASED METER

Reads ALL heads:

- Power: thermopiles, photodetectors and pyroelectrics
- Energy: thermopiles (in single shot mode), photodetectors and pyroelectrics

> MEASURE fJ ENERGY LEVELS

Thanks to a unique digital method for suppressing the noise on the lower ranges

> EXTERNAL TRIGGER

Synchronize your U-LINK to your pulsed laser or digital chopper (available on U-LINK (USB) model only)

> SYNCHRONIZE MULTIPLE CHANNELS

With the "SYNC. OUT" port, you can plug multiple U-LINK devices together and create a low-cost multi-channel system (available on U-LINK (USB) model only)

> SERIAL COMMANDS

Serial commands are available on both versions to let you take full control

> REAL-TIME STATISTICAL FUNCTIONS

Max, min, average, standard deviation, RMS and PTP stability.

CONNECTIVITY

U-LINK (USB)

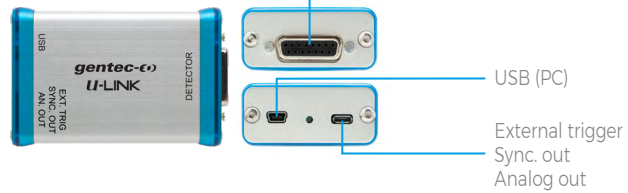

U-LINK (RS-232)

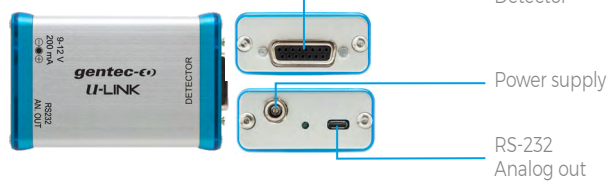

ACCESSORIES



USB, RS-232, external trigger & analog out cables



Pelican carrying case



Additional 9V power supply (RS-232 version only)



	U-LINK (USB)	U-LINK (RS-232)
DETECTOR TYPES	ALL MODELS: thermopiles, pyroelectrics, photodetectors	ALL MODELS: thermopiles, pyroelectrics, photodetectors
DISPLAY	1-Channel / PC-based	1-Channel / PC-based
POWER METER SPECIFICATIONS		
Power range	4 pW to 30 kW	4 pW to 30 kW
Resolution (digital)	23 bits on current scale	23 bits on current scale
Monitor accuracy	±0.5% ± 3 μV	±0.5% ± 3 μV
Statistics	Current value, max, min, average, std dev., RMS & PTP stability, time	Current value, max, min, average, std dev., RMS & PTP stability, time
ENERGY METER SPECIFICATIONS		
Energy range	2 fJ to 30 kJ	2 fJ to 30 kJ
Resolution (digital)	Current scale/3754	Current scale/3754
Monitor accuracy	1% ± 50 μV (< 500 Hz) / 2% ± 50 μV (500 Hz - 10 kHz)	1% ± 50 μV (< 500 Hz) / 2% ± 50 μV (500 Hz - 10 kHz)
Software trigger level	0.1 to 99.9%, 0.1% resolution, default 2%	0.1 to 99.9%, 0.1% resolution, default 2%
Repetition rate ^a	10 kHz	10 kHz
Real-time data transfer	10 kHz with time stamp, no missing point	10 kHz with time stamp, no missing point
Statistics	Current value, max, min, average, std dev., RMS & PTP stability, pulse #, repetition rate, average power	Current value, max, min, average, std dev., RMS & PTP stability, pulse #, repetition rate, average power
DETECTOR COMPATIBILITY		
Thermopile	Average power & single shot energy	Average power & single shot energy
Pyroelectric	Pulse energy & average power	Pulse energy & average power
Photodetectors	Average power & pulse energy	Average power & pulse energy
GENERAL SPECIFICATIONS		
Digital display	Computer screen	Computer screen
Data display	With PC-Gentec-EO: real-time, scope, averaging, statistics and digital tuning needle	With PC-Gentec-EO: real-time, scope, averaging, statistics and digital tuning needle
Serial commands and data transfer via	USB	RS-232
Real-time data transfer rate ^a	Up to 10 kHz with time stamp, no missing point (for pyroelectrics only)	Up to 10 kHz with time stamp, no missing point (for pyroelectrics only)
Analog output	0 - 2 V, full scale, ± 1%, user-defined	0 - 2 V, full scale, ± 1%, user-defined
External trigger	3.3 to 12 V	3.3 to 12 V
Dimensions	57W x 26H x 91D mm	57W x 26H x 91D mm
Weight	0.12 kg	0.12 kg
ORDERING INFORMATION		
Product page		

a. Maximum repetition rate and data transfer rate may vary with PC and detector speeds.

S-LINK

Dual & single channel, PC-based power and energy monitor



KEY FEATURES

- > **READS BOTH POWER AND ENERGY**
Thermopiles and pyroelectrics
- > **AVAILABLE WITH 1 OR 2 CHANNELS**
S-LINK-1 and S-LINK-2 models now available
- > **PC-BASED**
Connects to your PC with included software
- > **SERIAL COMMANDS**
Serial commands are available on all versions to let you take full control
- > **FASTEST DATA TRANSFER RATE**
Get all the points transferred directly into your PC at 10 kHz/channel
- > **USB OR ETHERNET**
Choose your favourite communications port.
- > **EXTERNAL TRIGGER**
Every model comes standard with a 2.4 V to 24 V external trigger

CONNECTIVITY

S-LINK-1
(Ethernet)

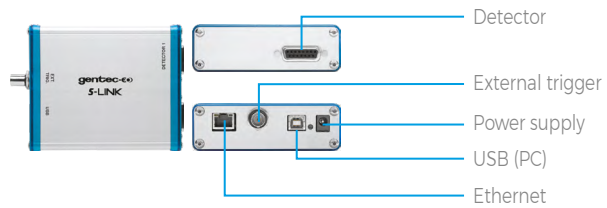

S-LINK-2
(Ethernet)

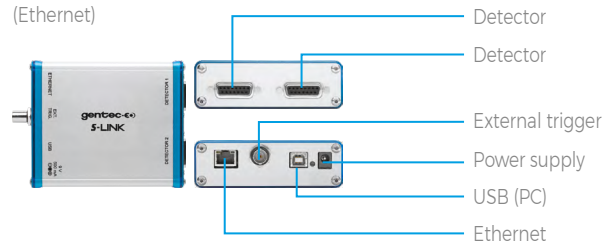

ACCESSORIES



Additional 9V power supply





USB cable



Pelican carrying case



	S-LINK-1	S-LINK-2
DETECTOR TYPES	Thermopiles, pyroelectrics	Thermopiles, pyroelectrics
CHANNELS / DISPLAY	1-Channel / PC-based	2-Channels / PC-based
POWER METER SPECIFICATIONS		
Power range	1 μ W to 10 kW	1 μ W to 10 kW
Monitor accuracy	$\pm 0.75\%$ for 10% to full scale	$\pm 0.75\%$ for 10% to full scale
Statistics	Current value, max, min, average, std dev., RMS & PTP stability, time	Current value, max, min, average, std dev., RMS & PTP stability, time
Response time	1 s	1 s
ENERGY METER SPECIFICATIONS		
Energy range	8 fJ to 20 kJ	8 fJ to 20 kJ
Resolution (digital)	Normal mode: Current scale/4096	Normal mode: Current scale/4096
Monitor accuracy		
< 500 Hz (MB), < 1200 Hz (MT)	1%	1%
500 to 1200 Hz (MB)	2%	2%
1200 to 6000 Hz (MT)	3%	3%
6000 to 10 000 Hz (MT)	6%	6%
Real time data transfer ^a	10 kHz in normal mode, no missing point	10 kHz/Channel in normal mode, no missing point
Statistics	Current value, max, min, average, std dev., RMS & PTP stability, pulse #, repetition rate, average power	
DETECTOR COMPATIBILITY		
Thermopile	Average power & single shot energy	Average power & single shot energy
Pyroelectric	Pulse energy	Pulse energy
GENERAL SPECIFICATIONS		
Number of channels	1	2
Digital display	Computer screen	Computer screen
Data display	Real-time, ratio, line plot, histogram, statistics and 3D histogram	Real-time, ratio, line plot, histogram, statistics and 3D histogram
Serial commands and data transfer via	USB or Ethernet	USB or Ethernet
Real-time data transfer rate	10 kHz/channel in normal mode, no missing point (for pyroelectrics only) ^a	10 kHz/channel in normal mode, no missing point (for pyroelectrics only) ^a
Rising edge external trigger	3-24 V at 13 mA, optically isolated	3-24 V at 13 mA, optically isolated
Dimensions	106W x 34H x 147D mm	106W x 34H x 147D mm
Weight	0.424 kg	0.424 kg
Ext. power supply	100/240 VAC 50 - 60 Hz to 9 VDC 1.66 A	100/240 VAC 50 - 60 Hz to 9 VDC 1.66 A
ORDERING INFORMATION		
Product page		

a. Actual rate may depend on the computer.

P-LINK

1 and 4 channels, PC-based power monitors



KEY FEATURES

- **READS ALL POWER DETECTORS TYPES**
Thermopiles and photodetectors of the PH Series
- **PC-BASED**
Connects to your PC with included software
- **MULTI-CHANNEL CAPABILITIES**
Available with 1 or 4 channels
- **SERIAL COMMANDS**
Serial commands are available on both versions to let you take full control
- **REAL-TIME STATISTICAL FUNCTIONS**
Max, min, average, standard deviation, RMS and PTP stability. Also high low alarm and post-analysis mode (P-LINK-4 only)
- **USB OR RS-232**
Choose your favourite communications port. The USB version is port-powered.

CONNECTIVITY

P-LINK (USB)

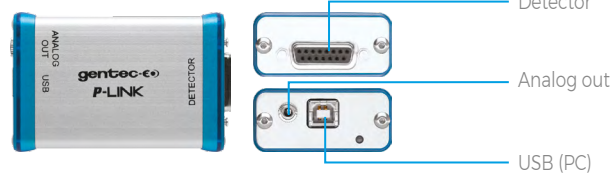

P-LINK (RS-232)

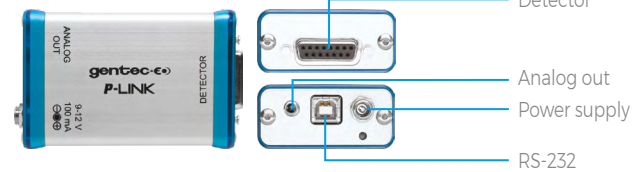

P-LINK-4

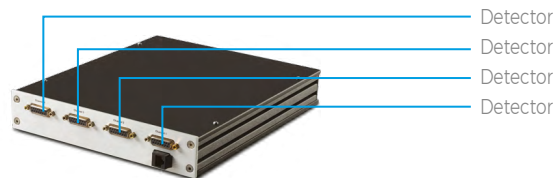

ACCESSORIES



Additional 9V power supply
(RS-232 version only)





USB & RS-232 cables



Pelican carrying case



	P-LINK (USB)	P-LINK (RS-232)	P-LINK-4 (USB)
DETECTOR TYPES	Thermopiles, photodetectors	Thermopiles, photodetectors	Thermopiles, photodetectors
CHANNELS / DISPLAY	1-Channel / PC-based	1-Channel / PC-based	4-Channels / PC-based
POWER METER SPECIFICATIONS			
Power range			
Thermopile	3 μ W to 10 kW	3 μ W to 10 kW	3 μ W to 30 kW
Photodetector	1 nW to 3 W	1 nW to 3 W	1 pW to 3 W
Monitor accuracy	\pm 0.5% full scale	\pm 0.5% full scale	\pm 0.5% full scale
Statistics	^a Current value, max, min, average, std dev., RMS & PTP stability, time	^a Current value, max, min, average, std dev., RMS & PTP stability, time	^b Current value, max, min, average, std dev., RMS & PTP stability, time
Response time	1 s	1 s	1 s
DETECTOR COMPATIBILITY			
Thermopile	Average power & single shot energy	Average power & single shot energy	Average power
Photodetector	Average power (mW, dBm)	Average power (mW, dBm)	Average power (mW)
GENERAL SPECIFICATIONS			
Number of channels	1	1	4
Digital display	Computer screen	Computer screen	Computer screen
Data display	^a Real-time, histogram, statistics, Digital tuning needle	^a Real-time, histogram, statistics, Digital tuning needle	^b Real-time, graphic, statistics, high/low alarm, Post-analysis mode, multi-channel
Analog output	0 - 2 Volt, adjustable, full scale, \pm 1%	0 - 2 Volt, adjustable, full scale, \pm 1%	N/A
Serial commands and data transfer via	USB	USB	USB
Real-time data transfer rate	10 Hz	10 Hz	10 Hz
Dimensions	57W x 26H x 91D mm	57W x 26H x 91D mm	286W x 233H x 43D mm
Weight	0.12 kg	0.12 kg	2.5 kg
External power supply	100/240 VAC 50 - 60 Hz to 12 VDC 200 mA	100/240 VAC 50 - 60 Hz to 12 VDC 200 mA	100/240 VAC 50 - 60 Hz to 5 VDC, 3 A
ORDERING INFORMATION			
Product page			

a. Using PC-Gentec-EO software.
b. Using Octolink software.

M-LINK

Single channel, PC-based universal power and energy monitor



KEY FEATURES

> THE UNIVERSAL PC-BASED METER

Reads ALL heads:

- Power: thermopiles, photodetectors and pyroelectrics
- Energy: thermopiles (in single shot mode), photodetectors and pyroelectrics

> MEASURE FJ ENERGY LEVELS

Thanks to a unique digital method for suppressing the noise on the lower ranges

> EXTERNAL TRIGGER

Synchronize your M-LINK to your pulsed laser or digital chopper

> DIGITAL (USB) OUTPUT

Connect the M-LINK module directly to your PC

> POWERFUL LABVIEW SOFTWARE

Features include:

- Complete instrument controls: range, trigger, wavelength, etc.
- Live display in J and J/cm² or W and W/cm²
- Full Statistics: min, max, mean, standard deviation, RMS stability, repetition rate, etc.
- Graphic displays: strip chart, histogram, tuning needle and more
- Data file collection and analysis

CONNECTIVITY

M-LINK

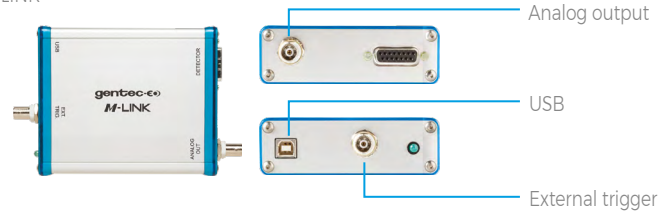

ACCESSORIES



USB cable



Pelican carrying case



M-LINK

DETECTOR TYPES	ALL MODELS: thermopiles, pyroelectrics, photodetectors
DISPLAY	PC-based
POWER METER SPECIFICATIONS	
Power range	4 pW to 30 kW
Resolution (digital)	Current scale/3000
Monitor accuracy	±0.5% ± 2 digits
Statistics	Current value, max, min, average, std dev., RMS & PTP stability, time

ENERGY METER SPECIFICATIONS

Energy range	30 fJ to 30 kJ
Resolution (digital)	Current scale/3000
Monitor accuracy	1% ± 2 digits (< 1 kHz)
Software trigger level	0.1 to 99.9%, 0.1% resolution, default 2%
Repetition rate ^a	1000 Hz
Real-time data transfer	1000 Hz with time stamp, no missing point
Statistics	Current value, max, min, average, std dev., RMS & PTP stability, pulse #, repetition rate, average power

DETECTOR COMPATIBILITY

Thermopile	Average power & single shot energy
Pyroelectric	Pulse energy & average power
Photodetectors	Average power & pulse energy

GENERAL SPECIFICATIONS

Digital display	Computer screen
Data display	Real-time, scope, averaging, statistics and digital tuning needle
Serial commands and data transfer via	USB
Real-time data transfer rate	1000 Hz with time stamp, no missing point (for pyroelectrics only)
Analog output	0 - 2 V, full scale, ± 2% (joulemeters) ± 4% (wattmeters)
Rising or falling edge external trigger	4.5 to 10 V @ 20 mA, optically isolated
Dimensions	106W x 34H x 147D mm
Weight	0.424 kg

ORDERING INFORMATION

Product page



a. Maximum repetition rate may vary with PC and detector speeds.

POWER DETECTORS

ENERGY DETECTORS

BEAM PROFILING

TERAHERTZ DETECTORS

DISPLAYS & PC INTERFACES

CUSTOM / OEM PRODUCTS

INTEGRA

Embedded PC interface



KEY FEATURES

- > **ALL-IN-ONE DETECTOR + METER**
Plug your detectors directly into your PC with the INTEGRA embedded PC interface
- > **INCREDIBLE PERFORMANCE**
INTEGRA detectors offer the same performance as the usual detector + PC interface combination
- > **USB OR RS-232**
INTEGRA detectors are offered with a choice of USB or RS-232 connector
- > **EXTERNAL TRIGGER**
An external trigger is available in option on every compatible INTEGRA energy detector
- > **COMPACT SIZE**
Perfect for the lab, OEM applications and field servicing. No need to carry a meter!
- > **LOWER RECALIBRATION COSTS**
One product = one calibration. Reduce your recalibration costs by half!
- > **UNIVERSAL SOFTWARE-PC-GENTEC-EO**
Control your INTEGRA detector with the same powerful software as the MAESTRO
- > **CUSTOMIZABLE**
Contact us for custom cable lengths and serial commands

CONNECTIVITY

- > Three models available:
 - USB output (-INT)
 - RS-232 output (-IDR)
 - USB with external trigger (-INE)

USB model name -INT



RS-232 model name -IDR



External trigger model name -INE



EASY TO MOUNT



Secure it on your Optical Table

WATCH OUT FOR THIS LOGO!

Available with
gentec-*eo* | integra



PC-GENTEC-EO

Universal software for INTEGRA, MAESTRO, P-LINK, U-LINK AND HP

MAIN CONTROLS



Complete and easily navigable software interface with all the necessary options and tools:

- Connection: Connect or Disconnect your device.
- Controls: Turn the Turbo Mode ON or OFF, make a Zero to remove the thermal offset, start the Acquisition of the data and start the calculations of the Statistics associated with this data.
- Startup Config: Save your measurements settings or Load the settings associated with an already existing file.
- Help: Get information about the PC-Gentec-EO software and read the user manual.
- Measure: Configure the parameters related to your measurements.
- Display: Set the desired number of digits and settings associated with the selected display.
- Acquisition: Enter the parameters related to the acquisition of data.

MEASUREMENT PARAMETERS

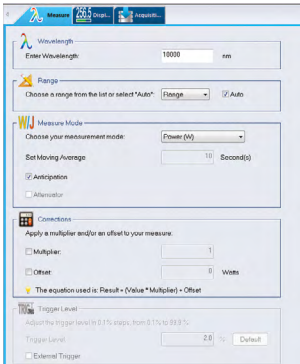

The Measure tab allows you to configure the parameters related to your measurements:

- Wavelength: Enter the Wavelength of your laser and the software will apply the appropriate correction factor on the measurements.
- Range: Set the power or energy Range to a fixed scale or let the software automatically adjust the scale.
- Measure Mode: Select the type of Measurement that will be displayed (power, energy) and let the software know if you want Anticipation and if there is any Attenuation.
- Corrections: Apply a Multiplication Factor and/or an Offset to your measurements.
- Trigger Level: Set the Trigger Level in 0.1% steps, from 0.1% to 99.9% (in energy mode only).

MULTIPLE DISPLAYS



Select the display that suits you best and watch your measurements in real time! With the options toolbar in the bottom of the interface, you can manage the displays at your convenience:

- Real-time: Real-time value and corresponding bar graph
- Scope: Line filling graph
- Needle: Fast analog-like needle
- Averaging: Shows trend of laser over time
- Histogram: Displays up to 100 bars
- Statistics: Min, Max, Average, RMS and PTP Stability, Rep. Rate and Standard Deviation

DATA ACQUISITION

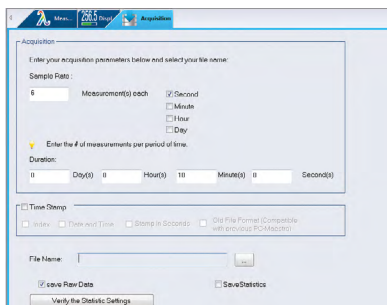

The Acquisition tab allows you to enter the parameters for data acquisition:

- Power Mode: Choose a Sampling Rate (number of measurements per interval of time), a Total Duration (in days, hours, minutes and seconds) for the data acquisition, a Time Stamp for each value and the File Name and File Location. You can choose to save only the raw data and/or the statistics associated with your data acquisition.
- Energy Mode: Choose a sampling rate (1 pulse out of X pulses), a total duration (total number of pulses) for the acquisition of data, a timestamp for each value, the file name and file location. Decide if you want to save raw data and/or the statistics associated with this data.

BLU

Wireless Bluetooth® PC interface



MEASURE WITH YOUR SMARTPHONE, TABLET OR PC

Display the results on your mobile device with the Gentec-EO BLU app available FREE on Google Play and Apple Store. Need to use it with a PC? Simply plug in the included Bluetooth receptor and use PC-Gentec-EO.



The Bluetooth® word mark and logos are registered trademarks owned by the Bluetooth SIG, Inc. and any use of such marks by Gentec-EO is under license.

KEY FEATURES

- **ALL-IN-ONE DETECTOR + METER**
This new line of All-in-One detectors combine a detector and a meter with Bluetooth connectivity in one convenient product. No need to carry a meter!
- **SAVE 50% ON CALIBRATION COSTS**
One product = one calibration. Reduce your recalibration costs by half!
- **EXTENSIVE COVERAGE**
Receive data at up to 30m from the detector, with the same performance as the usual detector + PC interface combination.
- **EASY TO SET UP**
Perfect for field service, labs and OEM applications.
- **GO WIRELESS**
No need to worry about cable length or PC interface location.
- **LONG BATTERY LIFE**
The USB-rechargeable Li-ion battery lasts up to 5 continuous days with the device running

WATCH OUT FOR THIS LOGO!

Available with



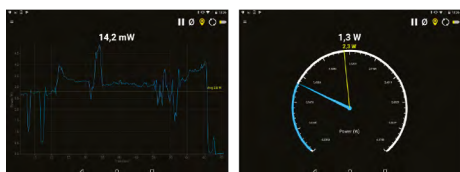
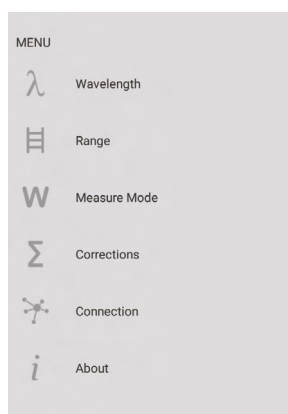
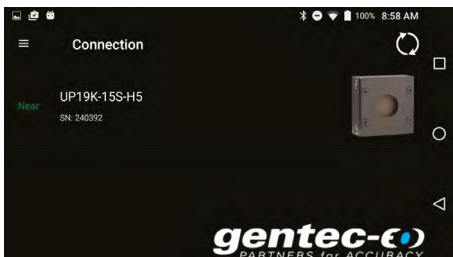

Scope

Needle

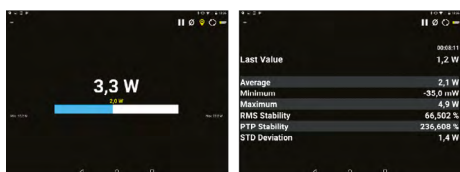

Real Time

Statistics

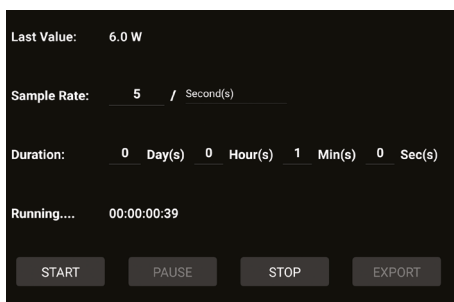

MAIN CONTROLS

Connecting a BLU device is very simple in the mobile application. Just open the app and it will automatically search for all available devices. Then, tap on the desired device in the list.

If there are no devices within range, the app will propose a simulator.

When a BLU detector is connected to a phone or computer, no other device can communicate with it.

MEASUREMENT PARAMETERS

The menu tab, available with the icon or by swiping from the left of the screen, allows you to configure the parameters related to your measurements:

- Wavelength:** Enter the wavelength of your laser and the software will apply the appropriate correction factor on the measurements.
- Range:** Set the power or energy range to a fixed scale or let the software automatically adjust the scale.
- Measure Mode:** Select the type of measurement that will be displayed: power, in watts (default) or single shot energy, in joules (energy/calorimeter mode).
- Corrections:** Apply a multiplication factor and/or an offset to your measurements.
- Trigger Level:** Set the trigger level in 0.1% steps, from 0.1% to 99.9% (in energy mode only).
- Connection:** Use this option to see the list of BLU devices within range.

MULTIPLE DISPLAYS

Select the display that suits you best and watch your measurements in real time! Simply swipe the screen to switch between the various displays:

- Scope:** Line filling graph; grab screenshots to save & share easily with your device
- Needle:** Fast analog-like needle
- Real-time:** Real-time value and corresponding bar graph
- Statistics:** Min, max, average, RMS and PTP stability and standard deviation

DATA ACQUISITION

The acquisition screen allows you to enter the parameters for data acquisition:

- Power mode:** Choose a sample rate (number of measurements per interval of time) and a duration (in days, hours, minutes and seconds) for the data acquisition.
- Energy mode:** Choose a sampling rate (1 pulse out of X pulses) and a duration (total number of pulses) for the acquisition of data.

Once the acquisition is complete, you can export the data to any of the data-sharing apps installed on your mobile device, or send it by email

CUSTOM / OEM PRODUCTS

Product characteristics

Gentec-EO offers OEM customers the highest flexibility so that you make no compromise. Whether you want a different housing, a specific sensitivity or another output connector, we have a solution for you. We will customize existing models or design a whole new detector to meet your needs.

COMPACTNESS

As an OEM, we know space is often a constraint. This is why we offer very compact detectors to ease the integration inside machines. Users can mix and match existing detectors and cooling modules from a large set of combinations.

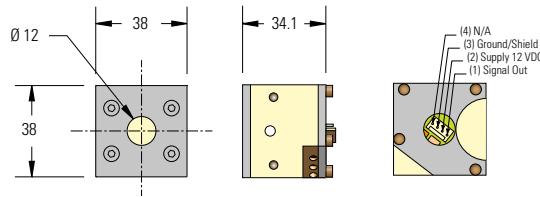
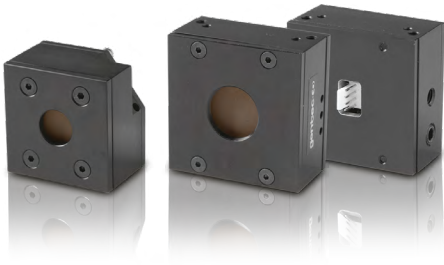

PERFORMANCE

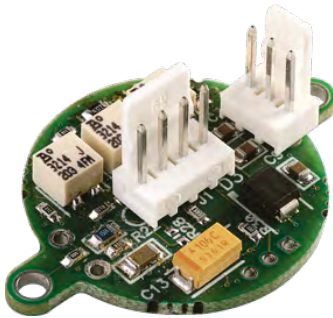

Anticipation

0-95% of the signal in as quickly as 0.3 s with the small UD12-70-H5 and in 0.6 s with the UD19-150-H5 using our external PCB.

Amplification

Adjust your disk sensitivity to get the perfect voltage for your acquisition system. Disks can be adjusted from 0.01 V/W up to 10 V/W depending on the model.

Filtering

Eliminate the high frequency noise coming from the environment with the integrated low-pass filter of our PCB.

CONNECTIVITY

Gentec-EO offers you several types of output connectors, from the more standard DB15, BNC and Molex to any exotic type you may need.

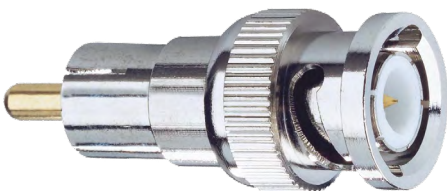

DB15

This connector contains an EEPROM with custom calibration data for both power and energy detectors.

BNC

The BNC output gives you fast, easy installation and direct connection to an oscilloscope

Molex or bare wires

The internal PCB gives an amplified signal output that can be accessed via a Molex connector and cable or bare wires. It is convenient for integrated systems.

CUSTOM / OEM PRODUCTS

Overview of the different models

Almost anything you see in our product line can be turned into an OEM unit! We also offer standard OEM products, at different levels of integration: from the simple thermopile disk to a complete head with internal PCB for signal anticipation and amplification.

POWER DETECTORS

ENERGY DETECTORS

BEAM PROFILING

TERAHERTZ DETECTORS

DISPLAYS & PC INTERFACES

CUSTOM / OEM PRODUCTS



UD SERIES

- Thermal sensor disks
- Designed for integration
- Many sizes and absorber choices:
 - 10, 12, 19, 25, and 55 mm Ø apertures
 - Broadband or high damage threshold coatings

■ THERMAL SENSOR DISKS

Available with
integra



UP SERIES



- Complete thermal heads with cooling modules
- Several sizes, coolings and absorber choices:
 - Apertures from 10 to 55 mm Ø
 - Broadband or high damage threshold coatings
 - Convection, fan or water-cooled
- DB15, USB, RS-232 or wireless

■ THERMAL SENSOR HEADS

UP SERIES WITH PCB



- Complete thermal heads with cooling modules
- Internal PCB for amplification, anticipation and filtering
- Several sizes, coolings and absorber choices:
 - 10, 12, 19, 25, 50 and 55 mm Ø apertures
 - Broadband or high damage threshold coatings
 - Convection, fan or water-cooled
- DB15, BNC or Molex connector, or bare wires

■ THERMAL SENSOR HEADS WITH PCB



Thermal sensor disks, 10 - 55 mm Ø, 200 µW - 500 W



HOW TO USE SENSOR DISKS

The UD thermal sensor disks were designed for integration into laser systems. They are the solution if you are engineering the cooling and signal processing into your system already.

The chart below and on the next page show the various possibilities that Gentec-EO offers to OEM users. The choice of a level of integration depends on your needs in terms of calibration, output signal level, cooling availability, etc.

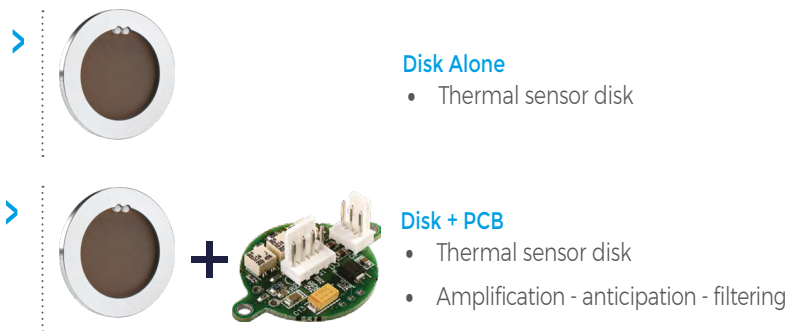

KEY FEATURES

- > **DESIGNED FOR INTEGRATION**
With a broad bandwidth and high power densities
- > **VERY THIN PROFILES**
Starting at only 2 mm deep
- > **VARIOUS APERTURE SIZES**
Choose your aperture from 10 mm Ø to 55 mm Ø
- > **2 LEVELS OF INTEGRATION**
 - Disk alone
 - Disk + PCB
- > **CUSTOM PRODUCTS**
Contact us for more options!



	UD10-2-H5-L	UD12-70-H5	UD19-50-W5	UD19-200-H9	UD25-350-H12	UD55-700-HD
MAX AVERAGE POWER (WATER-COOLED / FAN-COOLED)	2 W / 2 W	70 W / 30 W	50 W / 50 W	200 W / 110 W	350 W / 250 W	700 W / 600 W
EFFECTIVE APERTURE	10 mm ϕ	12 mm ϕ	19 mm ϕ	19 mm ϕ	25 mm ϕ	55 mm ϕ
MEASUREMENT CAPABILITY						
Spectral range	0.19 - 20 μm	0.19 - 20 μm	0.19 - 10 μm	0.19 - 20 μm	0.19 - 20 μm	0.19 - 20 μm
Noise equivalent power	0.1 mW	1 mW	1 mW	3 mW	10 mW	45 mW
Rise time (nominal) ^{a, b}	3.0 s	1.6 s	5 s	4.5 s	7.9 s	14 s
Sensitivity (typ into 100 kΩ load) ^b	2 mV/W	0.53 mV/W	0.65 mV/W	0.23 mV/W	0.1 mV/W	0.03 mV/W
Energy mode						
Sensitivity	2.4 mV/J	0.84 mV/J	0.33 mV/J	0.23 mV/J	0.05 mV/J	0.008 mV/J
Maximum measurable energy ^c 3 J	5 J	5 J	200 J	25 J	40 J	200 J
Noise equivalent energy ^a	5 mJ	20 mJ	23 mJ	60 mJ	200 mJ	250 mJ
DAMAGE THRESHOLDS						
Maximum average power density	36 kW/cm ²	36 kW/cm ²	100 kW/cm ²	45 kW/cm ²	45 kW/cm ²	45 kW/cm ²
Maximum energy density						
1064 nm, 360 μs, 5 Hz	5 J/cm ²	5 J/cm ²	100 J/cm ²	9 J/cm ²	9 J/cm ²	9 J/cm ²
1064 nm, 7 ns, 10 Hz	1 J/cm ²	1 J/cm ²	1.1 J/cm ²	1 J/cm ²	1 J/cm ²	1 J/cm ²
532 nm, 7 ns, 10 Hz	0.6 J/cm ²	0.6 J/cm ²	1.1 J/cm ²	0.6 J/cm ²	0.6 J/cm ²	0.6 J/cm ²
266 nm, 7 ns, 10 Hz	0.3 J/cm ²	0.3 J/cm ²	0.7 J/cm ²	0.3 J/cm ²	0.3 J/cm ²	0.3 J/cm ²
PHYSICAL CHARACTERISTICS						
Absorber	H5	H5	W5	H9	H12	HD
Dimensions	44 ϕ x 3D mm	36 ϕ x 2D mm	44 ϕ x 3D mm	44 ϕ x 3D mm	54 ϕ x 3D mm	85 ϕ x 4D mm
Weight (head only)	7 g	4 g	7 g	7 g	13 g	180 g
ORDERING INFORMATION						
Product page						

a. These characteristics depend on the thermal management and electronics provided by the user. Packaging, cooling and electronics similar to our UP Series detectors will provide similar performances. See UP Series specifications sheets for more details. Actual performance depends on the tradeoffs in a user's design. It may be possible to enhance some performance parameters at the expense of others.
 b. Without anticipation algorithm or circuitry.
 c. For 360 μs pulses. Higher pulse energy possible for long pulses (ms), less for short pulses (ns).

POWER DETECTORS
ENERGY DETECTORS
BEAM PROFILING
TERAHERTZ DETECTORS
DISPLAYS & PC INTERFACES
CUSTOM / OEM PRODUCTS

DISCRETE PYROS

Specifications

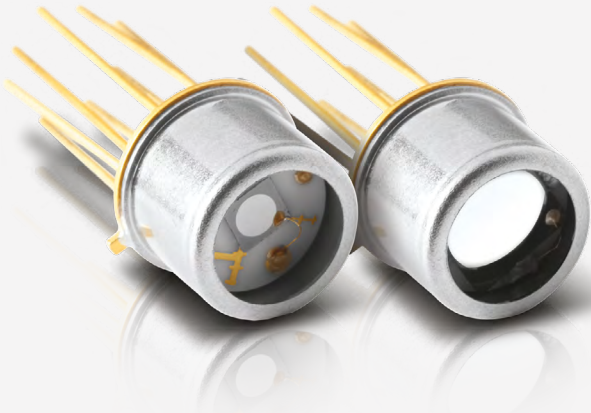

KEY FEATURES

- > **BROAD SPECTRAL RESPONSE**
From 0.1 to 1000 μm
- > **EASY TO INTEGRATE FORMAT**
TO5 and TO8 packages make the QS detectors small and easy to integrate in an existing system
- > **LARGE AREA SENSORS**
5 mm \varnothing and 9 mm \varnothing diameter pyroelectric sensors make optical alignment easier.
- > **TEST BOX AVAILABLE**
Can be used with our QS-I-TEST test box which provides mounting and power supply
- > **ROOM-TEMPERATURE OPERATION**
- > **FAST RESPONSE**

OUTPUT OPTIONS

- > **CHOOSE YOUR CONFIGURATION**
 - QS-L: Passive discrete pyroelectric detectors with thermally isolated crystal for high sensitivity (low noise) at low frequencies
 - QS-H: Passive discrete pyroelectric detectors with heat sink for high average power and high frequency operation
 - QS-IL: Current-mode hybrid sensors designed for high sensitivity, low bandwidth applications
 - QS-IF: Current-mode hybrid sensors designed for high frequency applications, up to 20 MHz
- > **SEVERAL IR WINDOWS IN OPTION**
 - Quartz: 0.2 - 3.0 μm
 - Barium fluoride: 0.2 - 17.5 μm
 - Sapphire: 0.1 - 7.0 μm
 - Silicon: 1.1 - 9.0 μm and 50 - 1000 μm
 - AR germanium: 8 - 14 μm

ACCESSORIES



QS-I-TEST
Evaluation test box (current)



Permanent IR windows
(Various types available)



Pelican carrying case

QS-I-TEST EVALUATION TEST BOX







QS-I-TEST	
Batteries	+9 V / -9 V
R _f resistors	10 ⁵ - 10 ¹⁰ Ω
C _f compensating	Yes
Package	101.6H x 127L x 58.4P
Optical mount	1/4"-20 threaded
Front bezel	SM1 (1.035-40)
Product number	201693

* For details, contact your Gentec-EO representative

Discrete pyro detectors, low noise level

	QS2-L	QS3-L	QS5-L	QS9-L
CURRENT RESPONSIVITY	0.5 $\mu\text{A/W}$	0.5 $\mu\text{A/W}$	0.25 $\mu\text{A/W}$	0.25 $\mu\text{A/W}$
EFFECTIVE APERTURE	2 mm \varnothing	3 mm \varnothing	5 mm \varnothing	9 mm \varnothing
PACKAGE	TO5	TO5	TO5	TO8
MEASUREMENT CAPABILITY				
Spectral range	0.1 - 1000 μm	0.1 - 1000 μm	0.1 - 1000 μm	0.1 - 1000 μm
Max average power	50 mW	50 mW	50 mW	50 mW
Capacitance (at 1000 Hz)	22 pF	60 pF	90 pF	250 pF
Current responsivity (at 630 nm)	0.5 $\mu\text{A/W}$	0.5 $\mu\text{A/W}$	0.25 $\mu\text{A/W}$	0.25 $\mu\text{A/W}$
Thermal frequency (3 dB)	1.6 Hz	0.8 Hz	0.5 Hz	0.25 Hz
Temperature coefficient	0.2%/°C	0.2%/°C	0.2%/°C	0.2%/°C
ORDERING INFORMATION				
Product page				

Discrete pyro detectors, high average power

	QS2-H	QS3-H	QS5-H	QS9-H
MAX AVERAGE POWER	500 mW	500 mW	500 mW	500 mW
EFFECTIVE APERTURE	2 mm \varnothing	3 mm \varnothing	5 mm \varnothing	9 mm \varnothing
PACKAGE	TO5	TO5	TO5	TO8
MEASUREMENT CAPABILITY				
Spectral range	0.1 - 1000 μm	0.1 - 1000 μm	0.1 - 1000 μm	0.1 - 1000 μm
Max average power	500 mW	500 mW	500 mW	500 mW
Capacitance (at 1000 Hz)	12 pF	30 pF	90 pF	250 pF
Current responsivity (at 630 nm)	0.25 $\mu\text{A/W}$	0.25 $\mu\text{A/W}$	0.25 $\mu\text{A/W}$	0.25 $\mu\text{A/W}$
Thermal frequency (3 dB)	5 Hz	5 Hz	5 Hz	5 Hz
Temperature coefficient	0.2%/°C	0.2%/°C	0.2%/°C	0.2%/°C
PHYSICAL CHARACTERISTICS				
Effective aperture	2 mm \varnothing	3 mm \varnothing	5 mm \varnothing	9 mm \varnothing
Package	TO5	TO5	TO5	TO8
Sensor	Pyroelectric	Pyroelectric	Pyroelectric	Pyroelectric
Absorber	MT	MT	MT	MT
Dimensions (excluding pins)	9.1 \varnothing x 6.4D mm	9.1 \varnothing x 6.4D mm	9.1 \varnothing x 6.4D mm	15.2 \varnothing x 6.4D mm
Weight	1.0 g	1.0 g	1.0 g	1.5 g
ORDERING INFORMATION				
Product page				

Hybrid pyro detectors, current mode, fast response

	QS2-IF	QS3-IF	QS5-IF	QS9-IF
VOLTAGE RESPONSIVITY	50 V/W	50 V/W	25 V/W	25 V/W
CURRENT RESPONSIVITY	0.5 μ A/W	0.5 μ A/W	0.25 μ A/W	0.25 μ A/W
EFFECTIVE APERTURE	2 mm \varnothing	3 mm \varnothing	5 mm \varnothing	9 mm \varnothing
PACKAGE	TO5	TO5	TO5	TO8

MEASUREMENT CAPABILITY

Spectral Range	0.1 - 1000 μ m	0.1 - 1000 μ m	0.1 - 1000 μ m	0.1 - 1000 μ m
Max average power	50 mW	50 mW	50 mW	50 mW
Noise equivalent power ^a	8×10^{-8} W/(Hz) ^{1/2}	8×10^{-8} W/(Hz) ^{1/2}	1.6×10^{-7} W/(Hz) ^{1/2}	1.6×10^{-7} W/(Hz) ^{1/2}
Detectivity ^a	2.2×10^6 cm(Hz) ^{1/2} /W	3.3×10^6 cm(Hz) ^{1/2} /W	2.8×10^6 cm(Hz) ^{1/2} /W	5.0×10^6 cm(Hz) ^{1/2} /W
Capacitance (at 1000 Hz)	22 pF	60 pF	90 pF	250 pF
Current responsivity (at 630 nm)	0.5 μ A/W	0.5 μ A/W	0.25 μ A/W	0.25 μ A/W
Voltage responsivity ^b	50 V/W	50 V/W	25 V/W	25 V/W
Thermal frequency (3 dB)	1.6 Hz	0.8 Hz	0.5 Hz	0.25 Hz
Feedback resistor	100 M Ω	100 M Ω	100 M Ω	100 M Ω
Supply voltage	± 12 V	± 12 V	± 12 V	± 12 V

PHYSICAL CHARACTERISTICS

Effective aperture	2 mm \varnothing	3 mm \varnothing	5 mm \varnothing	9 mm \varnothing
Package	TO5	TO5	TO5	TO8
Sensor	Pyroelectric	Pyroelectric	Pyroelectric	Pyroelectric
Absorber	MT	MT	MT	MT
Dimensions	9.1 \varnothing x 6.4D mm	9.1 \varnothing x 6.4D mm	9.1 \varnothing x 6.4D mm	15.2 \varnothing x 6.4D mm
Weight	1.0 g	1.0 g	1.0 g	1.5 g

ORDERING INFORMATION

Product page				
---------------------	---	---	--	---

a. 630 nm, 15 Hz, 1 Hz bandwidth

b. 630 nm, 15 Hz

Hybrid pyro detectors, current mode, low noise level

	QS2-IL	QS3-IL	QS5-IL	QS9-IL
VOLTAGE RESPONSIVITY	25 kV/W	25 kV/W	13 kV/W	13 kV/W
CURRENT RESPONSIVITY	0.5 μ A/W	0.5 μ A/W	0.25 μ A/W	0.25 μ A/W
EFFECTIVE APERTURE	2 mm \varnothing	3 mm \varnothing	5 mm \varnothing	9 mm \varnothing
PACKAGE	TO5	TO5	TO5	TO8

MEASUREMENT CAPABILITY

Spectral range	0.1 - 1000 μ m	0.1 - 1000 μ m	0.1 - 1000 μ m	0.1 - 1000 μ m
Max average power	50 mW	50 mW	50 mW	50 mW
Noise equivalent power ^a	2×10^{-9} W/(Hz) ^{1/2}	2×10^{-9} W/(Hz) ^{1/2}	6×10^{-9} W/(Hz) ^{1/2}	6×10^{-9} W/(Hz) ^{1/2}
Detectivity ^a	9.0×10^7 cm(Hz) ^{1/2} /W	1.3×10^8 cm(Hz) ^{1/2} /W	7.0×10^7 cm(Hz) ^{1/2} /W	1.3×10^8 cm(Hz) ^{1/2} /W
Capacitance (at 1000 Hz)	22 pF	60 pF	90 pF	250 pF
Current responsivity (at 630 nm)	0.5 μ A/W	0.5 μ A/W	0.25 μ A/W	0.25 μ A/W
Voltage responsivity ^b	25 kV/W	25 kV/W	13 kV/W	13 kV/W
Thermal frequency (3 dB)	1.6 Hz	0.8 Hz	0.5 Hz	0.25 Hz
Feedback resistor	100 G Ω	100 G Ω	100 G Ω	100 G Ω
Supply voltage	± 5 to ± 12 V	± 5 to ± 12 V	± 5 to ± 12 V	± 5 to ± 12 V

PHYSICAL CHARACTERISTICS

Effective aperture	2 mm \varnothing	3 mm \varnothing	5 mm \varnothing	9 mm \varnothing
Package	TO5	TO5	TO5	TO8
Sensor	Pyroelectric	Pyroelectric	Pyroelectric	Pyroelectric
Absorber	MT	MT	MT	MT
Dimensions	9.1 \varnothing x 6.4D mm	9.1 \varnothing x 6.4D mm	9.1 \varnothing x 6.4D mm	15.2 \varnothing x 6.4D mm
Weight	1.0 g	1.0 g	1.0 g	1.5 g

ORDERING INFORMATION

Product page				
---------------------	---	---	--	---

a. 630 nm, 5 Hz, 1 Hz bandwidth

b. 630 nm, 15 Hz

DISCRETE PYROS

Specifications

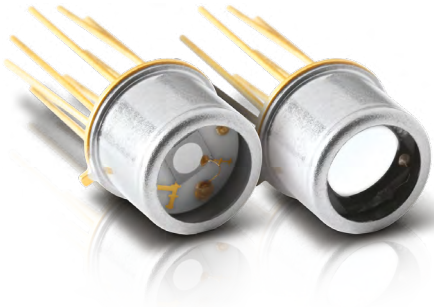

PYROELECTRIC THERMAL DETECTORS

Our pyroelectric detectors are a class of room temperature thermal detectors that produce a current output that is directly proportional to the rate of change of temperature when exposed to a source of radiation. They are best described by an AC current source, capacitor and resistor. Their current output is governed by the equation $I = p(T) \cdot A \cdot dT/dt$, where I is current, $p(T)$ is the pyro coefficient, A is the area as defined by the front electrode, and dT/dt is the rate of temperature change of the pyro crystal. The advantages of a pyroelectric detector over other IR detectors are: room temperature operation, broad spectral response, high sensitivity (D^*) and fast response (sub-ns into 50 Ω).

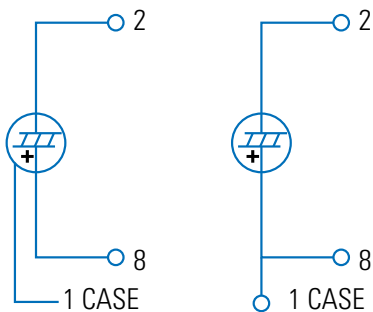

QS-L (left) and QS-H (right) pin-outs

QS-L AND QS-H DISCRETE PYROS

Our passive discrete pyroelectric detectors range from 1 to 9 mm in diameter and are provided in two configurations: high sensitivity or high average power. They present a pyroelectric detector element covered with our metallic coating (MT) and are packaged in a miniature TO-5 or TO-8 can. The diagram shown left identifies the pin-out for both types of detectors. Our organic black coating (BL), increases the optical absorption and helps flatten the spectral response. We also offer a number of permanent IR Windows that can be added to the TO can. These discrete pyro detectors are ideal for pulsed laser applications.

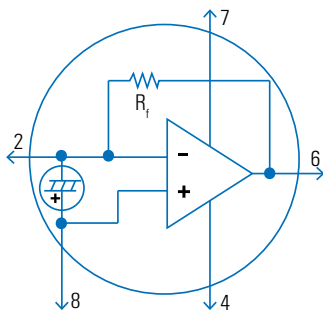

QS-IF and QS-IL pin-out

QS-IF AND QS-IL CURRENT MODE HYBRID PYROS

These detectors offer high gain ($>10^5$ V/W) and/or high bandwidth (>10 MHz). In this configuration, the pyroelectric detector element is combined to a low noise operational amplifier. The QS-IL models are designed for high performance at low to medium frequencies, while the QS-IF models offer good performance at medium to high frequencies. These detectors are very easy to use. Simply supply the ± 10 to 15 V to power the operational amplifier and add an external resistor, if required, to adjust the bandwidth and you are ready to measure pulsed, modulated or chopped sources, from nJ to mJ and nW to W. These detectors also make great candidates for any variety of broadband analytical instruments or laser measurement products.

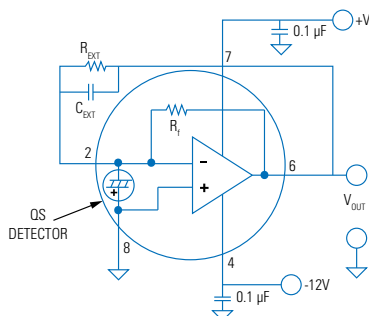

QS-IL circuitry

VOLTAGE OUTPUT VS. FREQUENCY

Our QS-IL hybrid detectors are designed to maximize voltage output at low frequencies and therefore include load and feedback resistors in the 100 G Ω to 300 G Ω range. They are also designed into 8-pin TO packages that allow the addition of an "external resistor" to lower the output and increase the bandwidth. The circuit diagram at the left shows a typical hook up for our QS5-IL detector (with our MT coating), using external resistors and capacitors. Our QS-IF series, on the other hand, are designed for high bandwidth applications and therefore include a smaller feedback resistor of 100 M Ω . For expert help on designing a detector circuit please contact us info@gentec-eo.com.

DISCRETE PYROS

Specifications

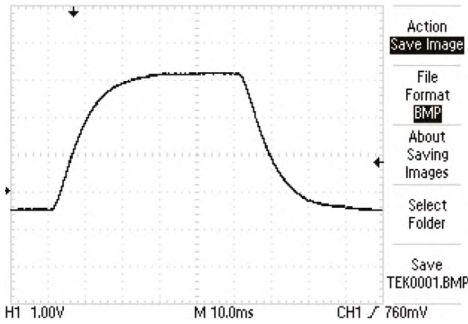

Typical QS-IL voltage output in power measurement mMode

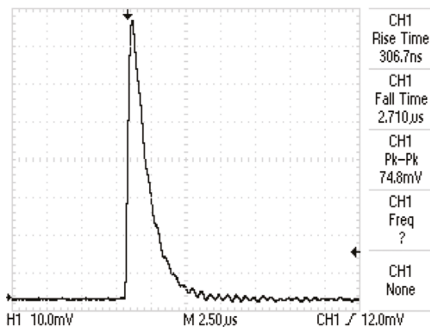

Typical QS-IL voltage output in energy measurement mode

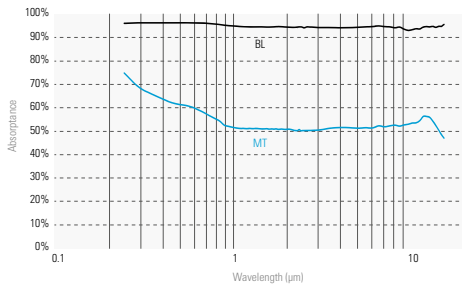

Absorption curves of QS pyroelectric detectors

OPERATION IN POWER MEASUREMENT MODE

When using our QS-IL hybrid detector to measure the power (in W) of your CW or high repetition rate source (quasi-CW), you will need to employ an optical chopper. The diagram at the left shows the typical voltage output of a QS5-IL when used with our QS-I-TEST evaluation test box. Note that the voltage output is an approximate “square wave” whose rise and fall times are governed by the RC time constant of the circuit. The optical power is directly proportional to the peak voltage minus the baseline voltage. We calibrate these devices when operating in this mode.

OPERATION IN ENERGY MEASUREMENT MODE

Our pyroelectric detectors are an ideal choice when measuring the performance of your pulsed laser in the range of nJ to mJ, across the full spectrum! The scope trace at the left represents the typical output from a QS9-IL, when used with our QS-I-TEST set up as an integrating joulemeter. Note the fast rise to a peak and then slower decay governed by the RC time constant selected for the integrating circuit. In this configuration you can measure absolute pulse energy, rep rate, and pulse-to-pulse stability. The maximum pulse width of your source is determined by the RC time constant you select and there is no limit as to how short the pulse can be!

BROAD SPECTRAL RESPONSE

Unlike photoconductive and photovoltaic detectors, our pyroelectric thermal detectors are not limited to a small part of the electromagnetic spectrum. They are truly broad spectrum detectors, sensitive from 0.1 µm to 3000 µm (EUV, FAR IR, and THz). Any and all radiation absorbed by our coatings or pyro crystal will result in a measurable signal. The two plots at the left show the relative spectral response of detectors with MT and BL coatings. Note that the well documented, NIST traceable calibrated portion of these curves runs from 0.25 µm to 15 µm. There are currently no traceable optical standards for measurements > 15 µm.

CUSTOM DESIGN EXAMPLES

Specifications



After over 50 years of experience in the laser beam measurement business, we have developed many customized solutions, sometimes for very unusual applications! This section is only a small portion of the projects we have accomplished for our customers, so do not hesitate to contact us with any special need you may have. We are always striving to find the perfect solution for your application!

CUSTOM DESIGN EXAMPLES

Specifications



EXTREMELY HIGH POWER, LOW BACK-REFLECTIONS

When working at extremely high average power, even a low % of back-reflections can be dangerous. To manage the back-reflections and provide a safer working environment, we can equip your high-power detector with a water-cooled "TUBE" extension.

This custom project example can measure up to 100 kW of average power continuously, and less than 4 % of the incident radiation is backscattered.

- CUSTOM-DESIGNED HIGH-POWER DETECTOR

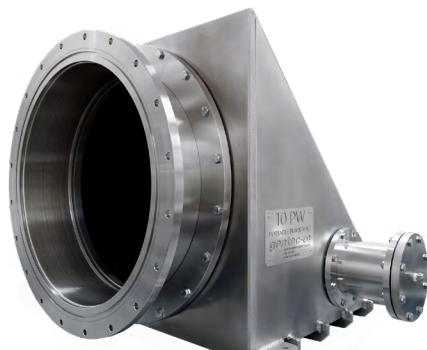

"10 PW PORTABLE BLACK HOLE"

Gentec-EO is the only supplier able to manufacture beam dumps able to withstand the tremendous peak power of a 10-petawatt laser, in a high vacuum environment.

By working closely with our client, we have designed the only existing beam dump that can fulfill the task of capturing and dissipating the energy contained in the single pulses of the ELI-NP end-of-line laser beams. Furthermore, this product was designed to be operated without external cooling, which simplifies its installation and makes it usable in a wide range of applications.

- UNRIVALED DAMAGE THRESHOLDS: UP TO 200 J/CM² FOR fs PULSES
- EXTREMELY LOW BACK-REFLECTIONS: < 0.02%

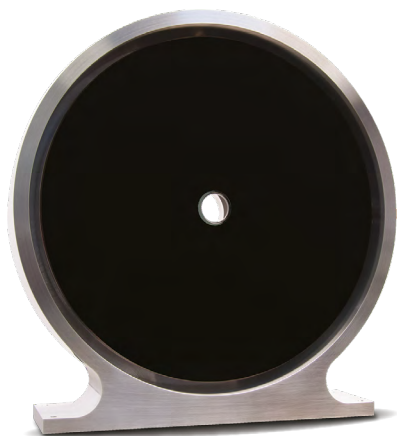

"HOLLOW" DETECTOR

This special calorimeter demonstrates the extent of Gentec-EO's customization capabilities. This product fulfills the requirements for the newest lasers for high energetic beam experimentation.

- High energy at low repetition rate for continuous measurement
- Femtosecond pulse
- Very large diameter with different shapes & sizes available
- Offers the flexibility to measure both power or energy
- Center hole option to let an electron beam through

- SHORT PULSES, HIGH ENERGIES
- VARIOUS SHAPES & SIZES

POWER DETECTORS

ENERGY DETECTORS

BEAM PROFILING

TERAHERTZ DETECTORS

DISPLAYS & PC INTERFACES

CUSTOM / OEM PRODUCTS

CUSTOM DESIGN EXAMPLES

Specifications



OPTICAL TRAP DETECTORS

Our optical TRAP detectors and their preamplifiers are used as primary spectral transfer standards in many metrology laboratories around the world.

These unique detectors are based on the use of two or three silicon photodiodes in an optical TRAP configuration. This results in extremely high quantum efficiency (QE) of greater than 99%. This extremely high QE renders the calibration uncertainty to record lows and allows one to calculate the precise current responsivity (A/W) at wavelengths in the 400 to 950 nm range using physical constants.

- HIGH QUANTUM EFFICIENCY
- HIGH PRECISION, THERMALLY STABLE, MULTI-GAIN PREAMPLIFIER

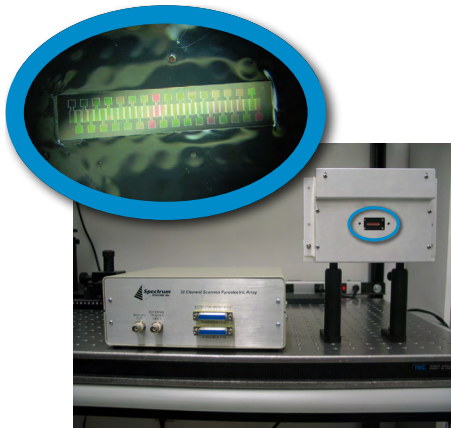

32-CHANNEL THZ PYROELECTRIC ARRAY

This self-scanned, linear, 32-element pyroelectric detector array was designed for use on a THz spectrometer. The spectrometer is used to characterize the "bunch length" of a high energy electron beam. It captures pulsed THz radiation at the 100 nJ level that help create interferograms as a diagnostic.

- BROAD SPECTRAL RESPONSE FROM 0.1 TO 3000 μm
- NOISE LEVEL LESS THAN 1 nJ



TEMPERATURE-CONTROLLED POWER METERS

Our temperature-controlled pyroelectric power detectors were designed for NIST. They are used as a spectral transfer standard, from 0.6 to 24 μm for their IR detector calibration systems.

The detector features BL black absorbing carbon coating for flat spectral response. The detector is mated to a thermoelectric cooler which maintains the probe's temperature at $25\text{ }^{\circ}\text{C} \pm 0.05\text{ }^{\circ}\text{C}$. This results in the ultimate measurement stability: the voltage responsivity (V/W) is stable to $\pm 0.1\%$.

- THE ULTIMATE MEASUREMENT STABILITY

CUSTOM DESIGN EXAMPLES

Specifications

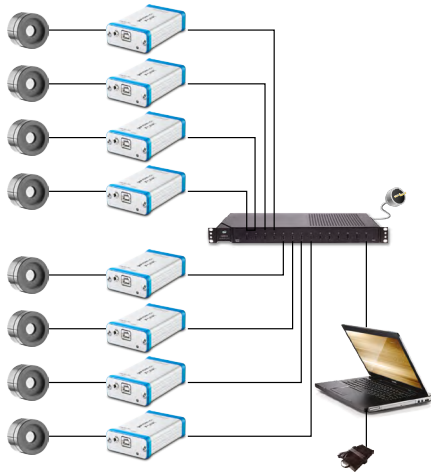

OCTOLINK

OCTOLINK is our multichannel software that was specifically designed for the simultaneous measurement of a large set of power detectors. As its name indicates, OCTOLINK allows the measurement of up to 8 devices simultaneously, all on a combined control screen. Furthermore, this tool offers full flexibility on the functionalities, allowing to control, compare and collect data of multiple detectors in a simple but effective manner. The channels can be user-set, allowing a transparent integration in the existing systems. Pass-fail feature and complete data logging make OCTOLINK an ideal and inexpensive solution for long term power monitoring.

- MEASURE 8 DETECTORS SIMULTANEOUSLY
- USER-SETTABLE INTERFACE



6-ELEMENT DETECTOR BAR

Custom detector integration that monitors multiple lasers in a system. This detector bar included six independent power sensors, covered by protection windows with anti-reflective coating, presence sensors, on-board signal conditioning and acquisition to instantly measure power and communicate with the system through industrial serial protocol.

- 6 ELEMENTS ON ONE BOARD
- INSTANTANEOUS POWER MEASUREMENT OF ALL 6 ELEMENTS
- DETECTOR ELEMENTS PROTECTED BY WINDOWS WITH AR COATING

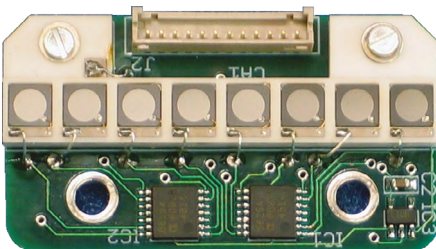

8-CHANNEL ARRAY FOR THZ TOMOGRAPHY

This eight-element, pyroelectric detector array was designed for use in a THz tomography system. It was used to analyze high pressure flames by measuring absorption in the water spectral bands, using THz radiation in the 0.5 to 2 THz region.

The detector elements are 3 mm diameter, accurately spaced on 5 mm centers. Its high responsivity and very low noise level allow precise detection of weak signals.

- 8-CHANNEL PYROELECTRIC ARRAY
- 0.5 TO 2 THZ RANGE
- HIGH VOLTAGE RESPONSIVITY

POWER DETECTORS

ENERGY DETECTORS

BEAM PROFILING

TERAHERTZ DETECTORS

DISPLAYS & PC INTERFACES

CUSTOM / OEM PRODUCTS

QUAD

Position sensing power & energy detectors



KEY FEATURES

- > **MEASURE, TRACK AND ALIGN**
With μm resolution in real time!
- > **4-CHANNEL DETECTORS**
Unique pyroelectric QUADrant detector technology handles high peak power without saturation
- > **FOR CW, PULSED AND HIGH REP RATE LASERS**
 - QUAD-E: Energy per pulse from μJ to mJ
 - QUAD-P: Powers from μW to mW
- > **FROM UV TO FIR AND THZ**
Broadband detectors cover the full spectrum, from UV to Sub-Millimeter wavelengths
- > **LARGE AREA SENSORS**
9 mm and 20 mm square detectors
- > **INCLUDES APPLICATION SOFTWARE**
Complete LabVIEW application software included, with many features

COMPATIBLE DISPLAYS & PC INTERFACES



QUAD-4Track module

ACCESSORIES



Stand with delrin post



Additional 9V power supply



USB cable



SDC-500 digital optical chopper (for -P)



Pelican carrying case



	QUAD-9-MT-E	QUAD-9-MT-P	QUAD-20-MT-E	QUAD-20-MT-P
MAX ENERGY / AVG POWER	20 mJ	200 mW	20 mJ	200 mW
MAX POSITION RESOLUTION	1 μ m	10 μ m	1 μ m	10 μ m
EFFECTIVE APERTURE	9 x 9 mm	9 x 9 mm	20 x 20 mm	20 x 20 mm
MEASUREMENT CAPABILITY				
Spectral range	0.1 - 3000 μ m	0.1 - 3000 μ m	0.1 - 3000 μ m	0.1 - 3000 μ m
Min beam size ^a	\geq 4.5 mm ϕ	\geq 4.5 mm ϕ	\geq 10 mm ϕ	\geq 10 mm ϕ
Position resolution with QUAD-4TRACK	1 μ m	10 μ m	1 μ m	10 μ m
Maximum measurable energy/power	20 mJ/channel	200 mW	20 mJ/channel	200 mW
Noise equivalent energy/power	0.5 μ J	1 μ W	1.0 μ J	2 μ W
Rise time (typical 0-100%)	150 μ s	< 0.02 s	150 μ s	< 0.02 s
Max repetition rate	1000 Hz	N/A	1000 Hz	N/A
Maximum pulse width	2.5 μ s	N/A	2.5 μ s	N/A
Maximum chopping frequency	N/A	50 Hz	N/A	50 Hz
Sensitivity	1000 V/J	2000 V/W	1000 V/J	2000 V/W
DAMAGE THRESHOLDS				
Max average power density (at 1064 nm)	100 mW/cm ²	100 mW/cm ²	100 mW/cm ²	100 mW/cm ²
Max energy density (at 1064 nm 10 ns)	50 mJ/cm ²	50 mJ/cm ²	50 mJ/cm ²	50 mJ/cm ²
PHYSICAL CHARACTERISTICS				
Effective aperture	9 x 9 mm	9 x 9 mm	20 x 20 mm	20 x 20 mm
Sensor type	Pyroelectric	Pyroelectric	Pyroelectric	Pyroelectric
Absorber	MT	MT	MT	MT
Dimensions	63.5 ϕ X 40.6D mm	63.5 ϕ X 40.6D mm	63.5 ϕ X 40.6D mm	63.5 ϕ X 40.6D mm
Weight	181 g	181 g	181 g	181 g
ORDERING INFORMATION				
Compatible stand	STAND-D-233	STAND-D-233	STAND-D-233	STAND-D-233
Product page				

a. For optimal performance.

POWER DETECTORS

ENERGY DETECTORS

BEAM PROFILING

TERAHERTZ DETECTORS

DISPLAYS & PC INTERFACES

CUSTOM / OEM PRODUCTS



QUAD-4Track
(front view)



QUAD-4Track
(rear view)



QUAD-4TRACK

The QUAD-4Track is a laser position sensing system designed to support our unique pyroelectric quadrant detectors, QUAD-P and QUAD-E. It is a 4-channel microprocessor-based system that measures the voltage output of each QUAD element and does the math necessary to provide a measurement of the X and Y displacement of a laser beam or image. It is fast and can be used to track, align and/or measure movement in real time, with a resolution of just a few microns!

SPECIFICATIONS & FEATURES

QUAD-4TRACK

Number of channels	4
Full scale ranges (4 decades) (E / P)	
Energy mode (with QUAD-E)	20 μ J to 20 mJ
Power mode (with QUAD-P)	200 μ W to 200 mW
USB connection to computer	YES (USB 2.0 full speed)
Power supply	9 VDC
Power on light	YES
Detector input	DB-25 connector
Detector analog output	BNC connector (0 - 2 V)
Trigger input (TTL)	BNC connector with LED indicator
Product number	201517

QUAD DETECTORS

Our large area pyroelectric quadrant detectors provide unique advantages over other position sensing detectors like silicon quads or lateral effect photodiodes. They are fast, handle high peak power of pulsed lasers without saturation and respond to lasers across the spectrum, from UV to Far IR and even THz. The QUAD-E is intended for use with pulsed sources at up to 1000 Hz, while the QUAD-P is designed for CW and High Repetition Rate (Quasi-CW) sources. Both types of detectors can also be used as standalone units, in an analog mode, for incorporation into your own system application. We can provide a Lemo cable for this purpose.

ANALOG OUTPUT

The analog output of the QUAD-4Track provides voltage that is directly proportional to the pulse energy or laser power irradiating each QUAD element. When the four voltage outputs are equal, the beam is centered on the QUAD detector. This provides a very useful tool when setting up our QUAD probes with your source for optical alignment.

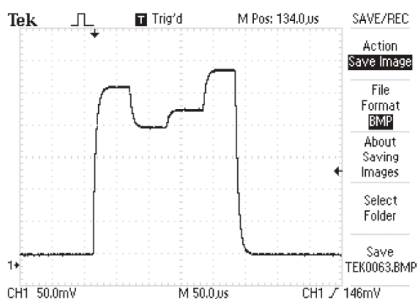

MEASUREMENT SCREEN

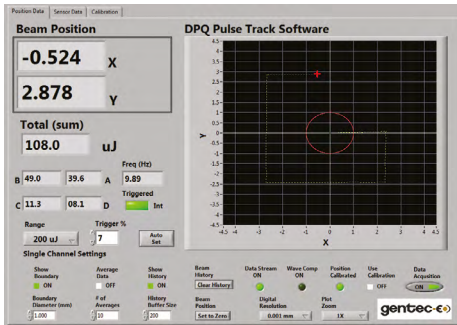

QUAD-4Track includes powerful, stand alone, LabVIEW software which is used to control the instrument, process the data, and display X and Y position. It also displays the energy or power of your source and repetition rate. The large graphic in this screen shows the position of the centroid of the beam and tracks its movement in real time. The software includes many handy features like: set boundary, zoom (2X to 128X), set resolution, data logging, and many more. The green line represents the tracking history.

TRACKING THE BEAM OVER TIME

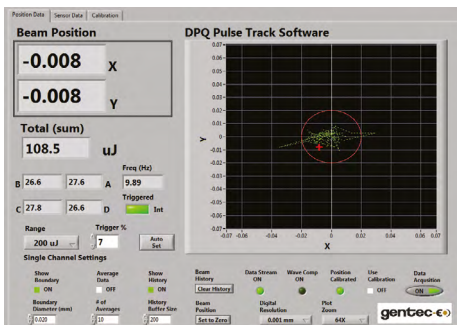

In the measurement screen shown on the left, we are tracking the beam stability of a pulsed Nd:YLF laser at 10 Hz. The resolution was set at 0.001 μm , the boundary is at 20 μm (red circle), and the zoom feature is at 64X. The total energy is 108.5 μJ , the final position of the laser is at -8 μm in X and -8 μm in Y. The green tracking line shows the movement of the laser about the zero position over a few hundred pulses.

POSITION CALIBRATION SCREEN

Set Positions	Measured Positions	Corrected Positions	Coefficients
-2.00E+0	-4.14E+0	-2.00E+0	H 7.32E-3
-1.50E+0	-3.66E+0	-1.50E+0	G 3.14E-1
-1.00E+0	-2.77E+0	-9.99E-1	F -4.03E-3
-5.00E-1	-1.51E+0	-5.01E-1	E 9.94E-3
0.00E+0	-1.86E-2	1.46E-3	D 6.40E-4
5.00E-1	1.50E+0	4.99E-1	C -8.66E-4
1.00E+0	2.76E+0	1.00E+0	B -2.17E-5
1.50E+0	3.62E+0	1.50E+0	A 5.12E-5
2.00E+0	4.11E+0	2.00E+0	

We've developed a unique position calibration routine which allows you to calibrate our QUAD-4Track system when working with a uniformly round laser beam. It requires the use of a micrometer-driven linear stage (1-axis only). As you can see from the calibration screen on the left, the procedure involves zeroing the instrument, moving the QUAD probe to nine discrete positions (+2.000 to -2.000 mm) and then capturing the QUAD readings. It then determines correction coefficients (last column) and applies them to the raw data to arrive at "corrected positions". The QUAD probe is now calibrated!

DATA LOGGING

Time	Energy (uJ)	X	Y
54:01.9	100.3	-0.008	-0.023
54:05.9	100.3	-0.013	-0.024
54:09.9	100.4	-0.015	-0.02
54:13.9	100.4	0.04	0.025
54:17.9	100.4	0.029	-0.069
54:22.0	100.4	-0.376	-0.08
54:26.0	100.3	-0.041	-0.069
54:30.0	100.4	-0.036	-0.073

Another very handy feature is "data logging". This allows you to set up the QUAD-4Track to follow the displacement, energy and/or power of your laser over several minutes, hours or even days. Need to measure the "beam steering" of your laser as it warms up? This is how you do it! Need to measure the beam displacement vs laser repetition rate or energy level? Data logging will help you measure it!

STEP

5 nW - 0.5 mW, temperature-controlled pyroelectric detectors for ultra-stable laser power measurements



KEY FEATURES

> SPECTRALLY FLAT RESPONSE

These radiometers were developed for NIST, to be used with a broadband spectrometer to act as a spectral transfer standard when calibrating other detectors in the 0.25 to 15 μm range.

> TEMPERATURE-CONTROLLED POWER MEASUREMENT

Each head is composed of a low noise detector, thermistor, TE cooler and heatsink to compensate for any temperature change

> THE ULTIMATE CHOICE IN MEASUREMENT STABILITY

Temperature control down to 0.05°C from 20 to 30°C gives a temperature coefficient < 0.01 %, thus a voltage output stable to 0.01 %

> 2 SIZES AVAILABLE

- TP5-BL: 5 mm \varnothing pyroelectric sensor with organic black coating
- TP9-BL: 9 mm \varnothing pyroelectric sensor with organic black coating

COMPATIBLE DISPLAYS & PC INTERFACES

Plug your TP sensor into the STEP-Controller for power supply and temperature control. You can then use the analog output with a scope or lock-in



STEP-Controller

ACCESSORIES



Stand with delrin post



Removable IR windows (Various types available)



Fiber adaptors & connectors (FC, SC, ST and SMA)



SDC-500 digital optical chopper (for -P)



Pelican carrying case

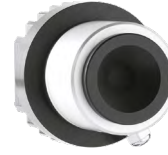

	TP5-BL	TP9-BL
MAX AVERAGE POWER	0.5 mW	0.5 mW
EFFECTIVE APERTURE	5 mm Ø	9 mm Ø
TEMPERATURE STABILITY	± 0.05°C	± 0.05°C
MEASUREMENT CAPABILITY		
Spectral range^a	0.25 - 15 µm	0.25 - 15 µm
Temperature stability	± 0.05°C	± 0.05°C
Voltage response stability	± 0.01 %	± 0.01 %
Maximum average power	0.5 mW	0.5 mW
Noise equivalent power^b	< 5 nW	< 5 nW
Rise time	≤ 0.2 s	≤ 0.2 s
Calibration uncertainty	±2.5 % (633 nm)	±2.5 % (633 nm)
Chopper frequency^c	10 Hz, 50% duty cycle	10 Hz, 50% duty cycle
DAMAGE THRESHOLDS		
Max average power density (at 1064 nm)	50 mW/cm ²	50 mW/cm ²
PHYSICAL CHARACTERISTICS		
Effective aperture	5 mm Ø	9 mm Ø
Sensor	Pyroelectric	Pyroelectric
Absorber	BL	BL
Dimensions	50.8Ø x 48.3D mm	50.8Ø x 48.3D mm
Weight	0.23 kg	0.23 kg
ORDERING INFORMATION		
Available output options	LEMO only	LEMO only
Compatible stand	STAND-D-233	STAND-D-233
Product page		

a. NIST-traceable calibration at 632.8 nm.
 b. With STEP-Controller and scope. Noise is < 11 nW with STEP-controller and Lock-In.
 c. SDC-500 optical chopper sold separately.

TRAP

Optical trap detectors



KEY FEATURES

- > **HAVE YOUR OWN GOLDEN CALIBRATION STANDARD**
The high quantum efficiency (>99%) makes it an excellent calibration transfer standard
- > **INCREDIBLE SPATIAL UNIFORMITY**
The spatial uniformity is better than 0.05 %
- > **LOW CALIBRATION UNCERTAINTY**
From 440 to 980 nm
- > **FOR DIVERGENT OR COLLIMATED BEAMS**
Devices optimized for both types of lasers
- > **MEASURE POWER FROM NW TO MW**
When used with the TRAP-PREAMP amplifier that provides a direct digital readout

COMPATIBLE DISPLAYS & PC INTERFACES

- > **TRAP -PREAMP**
Low noise, high gain amplifier

ACCESSORIES



Stand with delrin post



Pelican carrying case



	TRAP7-SI-C-BNC	TRAP7-SI-D-BNC
MAX AVERAGE POWER	1 mW	1 mW
EFFECTIVE APERTURE	7 mm ϕ	7 mm ϕ
BEAM TYPE	Collimated	Divergent
MEASUREMENT CAPABILITY		
Spectral range	200 - 1100 nm	200 - 1100 nm
Calibrated spectral range	440 - 980 nm	440 - 980 nm
Maximum average power	1 mW	1 mW
Noise equivalent power	100 pW	100 pW
Current responsivity (at 630 nm)	0.5054 A/W	0.5054 A/W
Beam type	Collimated	Collimated or divergent
Field of view	$\pm 10^\circ$	$\pm 14^\circ$
Quantum efficiency	> 99%	> 99%
Calibration uncertainty	< $\pm 1.0\%$ (440 - 980 nm)	< $\pm 1.0\%$ (440 - 980 nm)
Spatial uniformity	0.05 % in 5 mm diameter	0.05 % in 5 mm diameter
DAMAGE THRESHOLDS		
Maximum average power density	1 mW/cm ²	1 mW/cm ²
PHYSICAL CHARACTERISTICS		
Aperture diameter	7 mm ϕ	7 mm ϕ
Sensor	Silicon	Silicon
Dimensions	69 ϕ x 27.7D mm	69 ϕ x 27.7D mm
Weight	0.23 kg	0.23 kg
ORDERING INFORMATION		
Available output options	BNC only	BNC only
Compatible stand	STAND-D-233	STAND-D-233
Product page		

ACCESSORIES LIST

POWER SUPPLIES & BATTERIES



MODEL	DESCRIPTION	PART NUMBER
FAN-12V-US/EU/UK/CN	Power supply, 12V, for fan-cooled detectors	200130B/C/G/I
MON-9V-US/EU/UK/CN	Power supply, 9V. For displays & PC interfaces.	200960B/C/G/I
MON-BAT	Battery pack for: MAESTRO, SOLO 2.	201013
UPG-12V-US/EU/UK/CN	Power supply, 12V-6.66A, for UP55G	202199B/C/G/I

ADAPTORS & CABLES



MODEL	DESCRIPTION	PART NUMBER
B3-USB	Replacement USB3.0 cable for the Beamage cameras	202602
DB15-ADAPTOR	DB15 to DB15 replacement adaptor	Call
DB15-BNC	DB15 to BNC adaptor for QE12, QE25, QE50, QE65, QE95.	200036
EXT-#	Extension cable (various lengths available)	Call
PLK-RS-232	RS-232 cable for P-LINK (RS-232)	202375
MON-RS-232	RS-232 cable for : SOLO 2 and SOLO X (RS-232)	200925
MON-USB	USB cable for : P-LINK, S-LINK, M-LINK, Mach 6, T-Rad and QUAD-4Track	202373
MAE-USB	USB cable for : MAESTRO and U-LINK (USB)	202372
MAE-RS-232	RS-232 cable for MAESTRO and U-LINK (RS-232)	201860
MAE-TRIG	External trigger cable for MAESTRO and U-LINK (USB)	201956
MAE-ANALOG	Analog output cable for MAESTRO and U-LINK	201958
ULK-SYNC	Sync-out cable for U-LINK (USB)	205117

FIBER OPTIC ACCESSORIES



MODEL	DESCRIPTION	PART NUMBER
FOA-19	Fiber optic adaptor (19 mm threaded) for UP19 series.	200180
FOA-25	Fiber optic adaptor (25 mm threaded) for UP25 series.	200261
FOA-50	Fiber optic adaptor (50 mm threaded) for UP50-55 series.	200183
FOA-COVER12	Fiber optic adaptor cover for UP12E. 12 mm fiber adaptor cover for UP12E series.	202365
FOA-COVER50	Fiber optic adaptor cover for UP55. Reduces aperture from 55 to 50 mm.	202366
FOA-CYL50	Fiber optic adaptor: 50 mm conical cylinder for UP50 series.	200052
FOA-FULL-FC	Fiber optic adaptor FC with full cover. For: XLP12, -B heads (except THZ), PH, IS12 and STEP.	202367
FOA-FULL-SMA	Fiber optic adaptor SMA with full cover. For: XLP12, -B heads (except THZ), PH, IS12 and STEP.	202368
FOA-FULL-ST	Fiber optic adaptor ST with full cover. For: XLP12, -B heads (except THZ), PH, IS12 and STEP.	202369
FOC-FC	Fiber optic connector FC. For UP series.	200867
FOC-SC	Fiber optic connector SC. For UP series.	200182
FOC-SMA	Fiber optic connector SMA. For UP series.	200868
Threaded Adaptor for Pronto-Si	Threaded adaptor for Pronto-Si. Can be used for any SMI-compatible optics, such as FOA-FULL-FC and ND filters.	203502

ACCESSORIES LIST

POUCHES AND CASES



MODEL	DESCRIPTION	PART NUMBER
MON-WALL	Wall support for : MAESTRO, TUNER, UNO.	201241
PEL-####	Pelican carrying case with custom-cut foam insert.	Call

STANDS & HOLDERS



MODEL	DESCRIPTION	PART NUMBER
STAND-D-233	Stand with 2 x 3in base, 3in cylinder, Delrin post, 1/4"-20 & 8-32 for : QE-B, QE12, QE25, QE50, QE65-S, QE95-S, Mach 6, UM-B, STEP, PH-B, PH, PE-B, TRAP, THZ-I-BNC, THZ-B, Beamage, QUAD.	200428
STAND-D-443	Stand with 4 x 4in base, 3in cylinder, Delrin post, 1/4"-20 & 8-32 for : QE65-H, QE95-H	201284
STAND-S-233	Stand, 2 x 3in base, 3in cylinder, Steel post, 8-32 & 1/4"-20 for : XLP12, UP12, UP17, UP19, THZ-D, Pronto-Si and Pronto-250	200160
STAND-S-443	Stand, 4 x 4in base, 3in cylinder, Steel post, 8-32 & 1/4"-20 for : UP25, UP50, UP55 and Pronto-500/3K/6K/10K.	200234
STAND-S-443-C	Stand, 4 x 4in base, 3in cylinder, 3in Steel post, 8-32 & 1/4"-20, with slip-on post collar for : UP55G, UP60G and HP.	201102
STAND HP280A-30KW-HD	Stand for HP280A, 12 x 18in breadboard base with two 18in posts and mounting brackets	205517

WINDOWS & FILTERS



MODEL	DESCRIPTION	PART NUMBER
IR-FILTER	IR-FILTER for XLP12.	Call
M6-UV-QED	Special attenuator for M6 ultrafast pyroelectric probes. Allows relative measurements in UV.	Call
QED-12	QE12 attenuator.	201200
QED-25	QE25 attenuator.	201199
QED-50	QE50 attenuator.	201198
QED-65	QE65 attenuator.	201282
QED-95	QE95 attenuator.	201323
OD0.3	OD0.3 attenuator for PH series	Call
OD1	OD1 attenuator for PH series	201082
OD2	OD2 attenuator for PH series	202374
Various Windows	Interchangeable or permanent windows (barium, quartz, germanium, sapphire, silicon, zinc)	Call

MISCELLANEOUS



MODEL	DESCRIPTION	PART NUMBER
APM (D)	Analog Power Module, to interface -B heads with oscilloscopes or lock-in amplifiers. Requires adaptor when used with M6 heads.	201848
BL	Organic Black (BL) Coating for QS pyroelectric detectors (not for QS-THZ).	Call
EXT-PCB	External PCB for UD Disks.	Call
QS-I-TEST	Evaluation Test Box for QS Detectors (in current mode).	201693
SDC-500	SDC-500 Digital Optical Chopper.	202171
UP19K-COVER	Threaded cover for UP19 Series detectors	202377
UP19K-TUBE	Isolation Tube for UP19K	202376
XLP12-TUBE	Isolation tube with SM1 thread for: XLP12, UP10P, PE-B, PH, QE-B, UM-B, THZ-B and IS12.	101449
HP-TUBE	Water-cooled tube for HP100A-4KW-HE and HP100A-12KW-HD. The HP detector needs to be sent back to be retrofitted and recalibrated (Calibration is included). It is NOT POSSIBLE to install the HP-TUBE in the field.	Call
HP-WF-MET/IMP	Water filter for HP Series	202984

DISTRIBUTORS WORLDWIDE

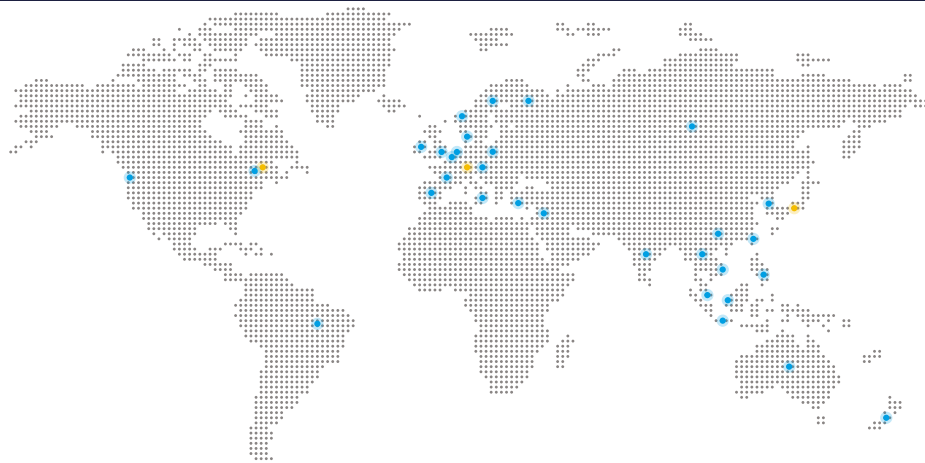

● Countries with a calibration center

● Countries with a Gentec-EO office

AMERICAS

UNITED STATES & CANADA - WEST COAST	GENTEC ELECTRO-OPTICS, INC.	Paige Stevens	pstevens@gentec-eo.com	gentec-eo.com
UNITED STATES & CANADA - EAST COAST	GENTEC ELECTRO-OPTICS, INC.	Ahmed Rihane	arihane@gentec-eo.com	gentec-eo.com
SOUTH AMERICA	PHOTONICS LTDA	Ettore Cortese	info@photonics.com.br	photonics.com.br

EUROPE

FRANCE	LASER COMPONENTS S.A.S.	Elvyne Egrot	e.egrot@lasercomponents.fr	lasercomponents.com
GERMANY, AUSTRIA, CZECHIA & POLAND	LASER COMPONENTS GMBH	Nadine Kujath	n.kujath@lasercomponents.com	lasercomponents.com
GREECE	OPTRONICS TECHNOLOGIES S.A.	Nina Christodoulia	nchristodoulia@optronics.gr	optronics.gr
ITALY	OPTOPRIM S.R.L.	Daniele Turiano	turiano@optoprim.it	optoprim.it
LITHUANIA, ESTONIA, BELARUS & LATVIA	STANDA	Jonas Kniuksta	sales@standa.lt	standa.lt
NETHERLANDS, BELGIUM & LUXEMBOURG	TE LINTELO SYSTEMS BV	Roland Kuijvenhoven	roland@tlsbv.nl	tlsbv.nl
SPAIN & PORTUGAL	PRO-LITE TECHNOLOGY IBERIA, S.L.	Luz Ruiz	luz.ruiz@pro-lite.es	pro-lite.es
SWEDEN, DENMARK, FINLAND & NORWAY	LASER COMPONENTS NORDIC AB	Harvey Washbrook	h.washbrook@lasercomponents.se	lasercomponents.com
SWITZERLAND	GMP SA	Pablo Moreno	pablo.moreno@gmp.ch	gmp.ch
TURKEY	TLS LAZER	Mustafa Ersin	m.ersin@tislaser.com	tislaser.com
UNITED KINGDOM & IRELAND	LASER LINES LTD	Dan Cort	danc@laserlines.co.uk	laserlines.co.uk

ASIA-PACIFIC

AUSTRALIA & NEW ZEALAND	LASTEK PTY LTD.	Jessica Mackintosh	sales@lastek.com.au	lastek.com.au
CHINA & HONG KONG	OPCROWN PHOTONICS CO., LTD.	Gloria Yang	gloria.yang@opcrown.com	opcrown.com
INDIA	SOLUTIONS FOR LASERS & PHOTONICS PVT LTD.	Abhishek Losalka	info@lasersandphotonics.com	lasersandphotonics.com
JAPAN	GENTEC-EO JAPAN GK	Daisuke Sato	dsato@gentec-eo.com	gentec-eo.com
KOREA	QBIC LASER SYSTEM, INC.	Changkon Kim	sales@qbiclaser.com	qbiclaser.com
MALAYSIA	DESEO ENTERPRISE	Eddy Looi	sales@deseoent.com	deseoent.com
RUSSIAN FEDERATION	ETM PHOTONICS LLC	Vladimir Shershulin	sales@etm-p.ru	etm-p.ru
SINGAPORE & PHILIPPINES	ACEXON TECHNOLOGIES PTE LTD	Lawrence Chua	sales@acexon.com	acexontech.com
TAIWAN	ONSET ELECTRO-OPTICS	Patrick Huang	sales@onset-eo.com	onset-eo.com
THAILAND	WETLING CO., LTD	Phakkawat Attaphiphatwanich	sales@laser-gen.com	laser-gen.com
VIETNAM	ATEK PHOTONICS CO., LTD	Nguyen Tat Thanh	thanh.nt@atekvietnam.com	atekvietnam.com

MIDDLE EAST - AFRICA

ISRAEL	LAHAT TECHNOLOGIES LTD.	Yamit Avni	yamit.avni@lahat.com	lahat.com
UNITED ARAB EMIRATES	ARABIAN CALIBRATION DEV. REP. CO. LLC	Jude Dias	sourcing@arabcal.com	arabcal.com

ALL OTHER COUNTRIES

ALL OTHER COUNTRIES	GENTEC ELECTRO-OPTICS, INC.	Charles Dumas	cdumas@gentec-eo.com	gentec-eo.com
---------------------	-----------------------------	---------------	--	--

RETURN & WARRANTY

CALIBRATION AND REPAIR SERVICE

All Gentec-EO products receive an NIST traceable calibration and are shipped with a Calibration Certificate to prove it. The certificate tells you the sensitivity of your power or energy head, the ambient calibration conditions, and a list of all the NIST traceable standards and instruments used in the calibration.

The actual need for recalibration depends on use and environmental conditions. Under typical operating conditions and laser exposures annual recalibration is the industry standard recommended by calibration experts such as NIST. Our highly professional service department is happy to recalibrate or repair your instrument any time you need it. In every case, you will get the same accurate calibration and detailed certificate as when your instrument was new. In addition, we do an incoming calibration test to let you know how the device was performing before service. We will help you meet any ISO and quality requirements. Here is how to send an RMA request:



BY PHONE

Mr. Nicolas Litalien
1-418-651-8003 ext. 302



BY E-MAIL

Mr. Nicolas Litalien
service@gentec-eo.com



USING OUR ONLINE RMA FORM

Go to <https://www.gentec-eo.com/contact-us/support-rma-request>
Fill out the online form and click "SUBMIT MY REQUEST"



■ IN ALL CASES, PLEASE PREPARE THE FOLLOWING INFORMATION BEFORE CONTACTING US:

- Model name(s)
- Serial number(s)
- If a repair is needed, please provide a description of the problem

LASER COMPONENTS Germany GmbH
Werner-von-Siemens-Str. 15
82140 Olching
Tel +49 8142 2864-0
info@lasercomponents.com

beyond borders



LEADER IN LASER BEAM MEASUREMENT SINCE 1972

CANADA

445 St-Jean-Baptiste, Suite 160
Quebec, QC, G2E 5N7, Canada

T (418) 651-8003

F (418) 651-1174

✉ info@gentec-eo.com

UNITED STATES

5825 Jean Road Center
Lake Oswego, OR, 97035, USA

T (503) 697-1870

F (503) 697-0633

✉ info@gentec-eo.com

JAPAN

Office No. 101, EXL111 building,
1-1-1, Takinogawa, Kita-ku, Tokyo
114-0023, Japan

T +81-3-5972-1290

F +81-3-5972-1291

✉ info@gentec-eo.com

CALIBRATION CENTERS

445 St-Jean-Baptiste, Suite 160
Quebec, QC, G2E 5N7, Canada

Werner von Siemens Str. 15
82140 Olching, Germany

Office No. 101, EXL111 building,
1-1-1, Takinogawa, Kita-ku, Tokyo
114-0023, Japan