

850nm 8mW VCSEL with Photodiode VP-0850I-008M-XX-1A0

Features

- 850nm single wavelength
- Low wavelength drift
- Oxide isolation technology
- Low threshold current
- Small emission area
- Easy to collimate

Applications

- Proximity sensor
- Consumer electronics
- Active optical cable
- Medical applications
- Range finder sensors
- Modulation bandwidth >2GHz

PRODUCT IDENTIFY

Part Number	Description
VP-0850I-008M-XX-1A0	850nm 8mW VCSEL with Photodiode

CODE RULES:

e.g. VP-0850I-008M-XX-1A0

① ② ③ ④ ⑤ ⑥ ⑦ ⑧ ⑨ ⑩

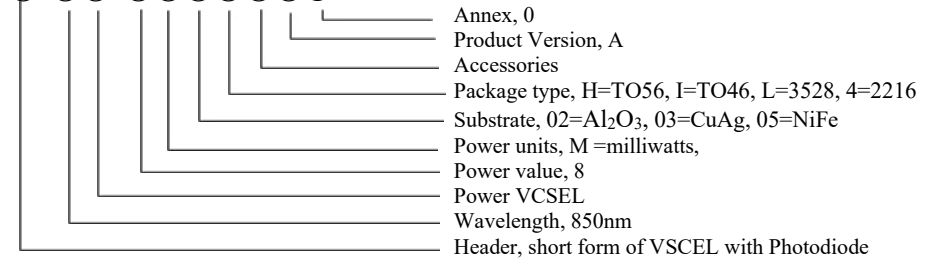

I. Absolute maximum ratings

Parameter	Symbol	Rating	Unit
Case Operating Temp	Top	-40 to 70	°C
Storage Temp	Tsto	-40 to 85	°C
Reflow Soldering Temperature	Tsdr	260°C(10s)	°C
Reverse Voltage	Vr	5	V
Maximum Continuous Current	Imax	12	mA
ESD exposure (Human body) model	ESD	2-4K (Class 2)	V
ESD exposure (Machine) model	ESD	200-400 (Class B)	V

Note:

1. Stresses greater than those listed under "Absolute Maximum Ratings" may cause permanent damage to the device. This is a stress rating only and functional operation of the device at these or other conditions above those indicated in the operations section for extended periods of time may affect reliability.
2. In its maximum rating diode laser operation could damage its performance or cause potential safety hazard such as equipment failure.
3. Electrostatic discharge is the main reason for the laser fault of the diode. Take effective precautions against ESD. When dealing with laser diodes, use the wrist strap, grounding work surface and strict antistatic technology.

II. Optical-electrical characteristics @25°C , CW mode

Parameters	Symbol	Conditions	Min.	Typ.	Max.	Units
Optical Power Output	P_o	$I_F=11.2\text{mA}$		8	10	mW
Threshold Current	I_{TH}	-	-	0.5	-	mA
Slope Efficiency	η	$P_o=8\text{mW}$	-	0.6	-	mW/mA
Power Conversion Efficiency	PCE	$I_F=11.2\text{mA}$	-	28	-	%
Peak Wavelength	λ_p	$I_F=11.2\text{mA}$	840	850	860	nm
Laser Forward Voltage	V_F	$I_F=11.2\text{mA}$		2.5	2.7	V
Series Resistance	R_S	$I_F=11.2\text{mA}$	-	60	-	Ohm
Beam Angle	θ	$I_F=11.2\text{mA}$	-	25	-	Degrees
Wavelength shift	$\partial\lambda_p/\partial T$	$I_F=11.2\text{mA}$	-	-	0.07	nm/°C
			-	-	-	-
Soldering Temperature	-	$\text{Al}_2\text{O}_3, \text{NiFe}$	-	-	260(10s)	°C
	-	CuAg	-	-	180(10s)	°C
Substrate	$\text{Al}_2\text{O}_3, \text{NiFe}, \text{CuAg}$					

Parameters	Conditions	Symbol	Unit	Min.	Typ.	Max.
Forward Voltage	$I_F=10\text{mA}$, $E_e=0\text{mW/cm}^2$	V_F	V			1.2
Reverse Breakdown Voltage	$I_{BR}=10\mu\text{A}$, $E_e=0\text{mW/cm}^2$	V_{BR}	V	33		
Reverse Dark Current	$V_R=10\text{V}$, $E_e=0\text{mW/cm}^2$	I_D	nA			5
Total Capacitance	$V_R=5\text{V}$, $F=1\text{MHz}$	C_j	pF		1.1	

Note: Electro-Optical Characteristic with a package or diffuser would require further evaluation. Values are based on limited sample size and estimated values.

III. LIV Graph, wavelength and relative spectral responsivity

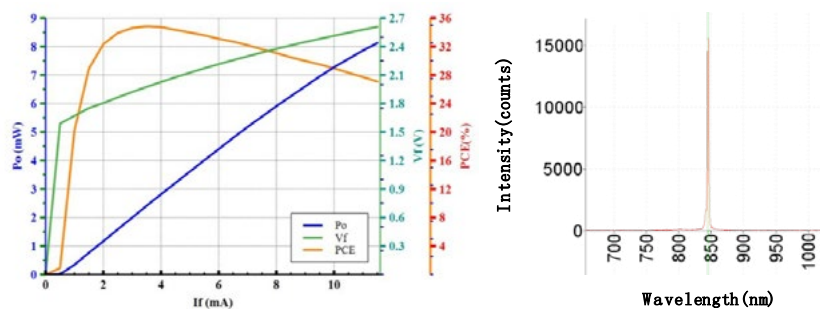

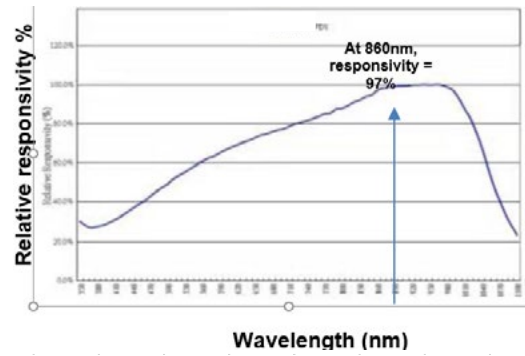

IV. Mechanical Schematics (unit:mm)

VP-0850I-008M-24-1A0 (Substrate Al₂O₃, Package 2216 with PD)

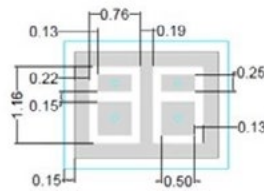

TOP VIEW

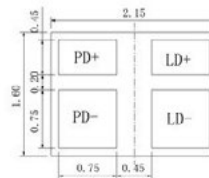

Bottom View

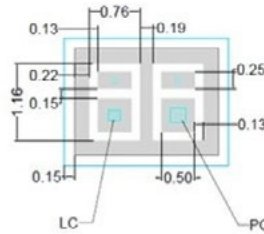

TOP VIEW

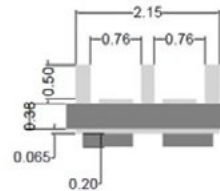

VP-0850I-008M-3L-1A0 (Substrate CuAg, Package 3528 with PD)

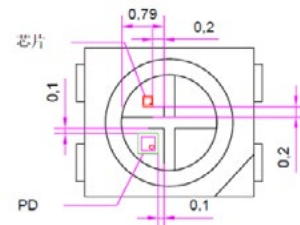
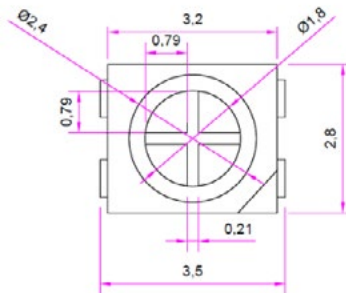

VP-0850I-008M-5H-1A0 (Substrate NiFe, Package TO56 with PD)

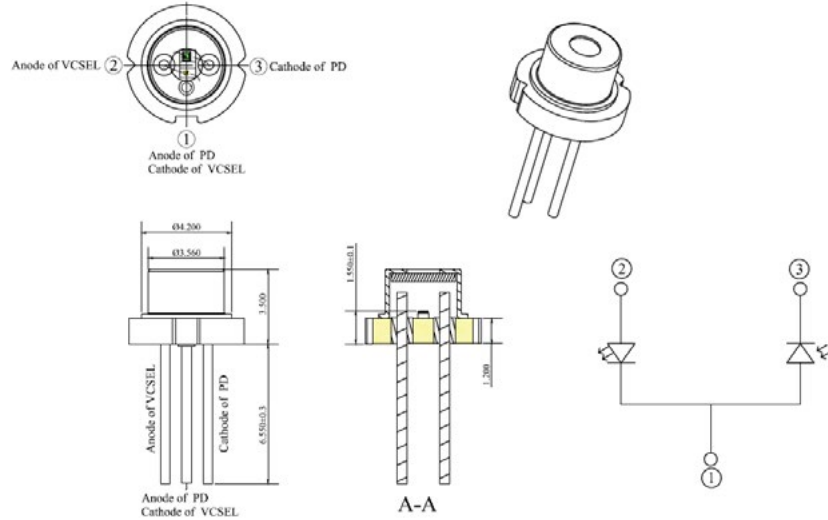

VP-0850I-008M-5I-1A0 (Substrate NiFe, Package TO46 with PD)

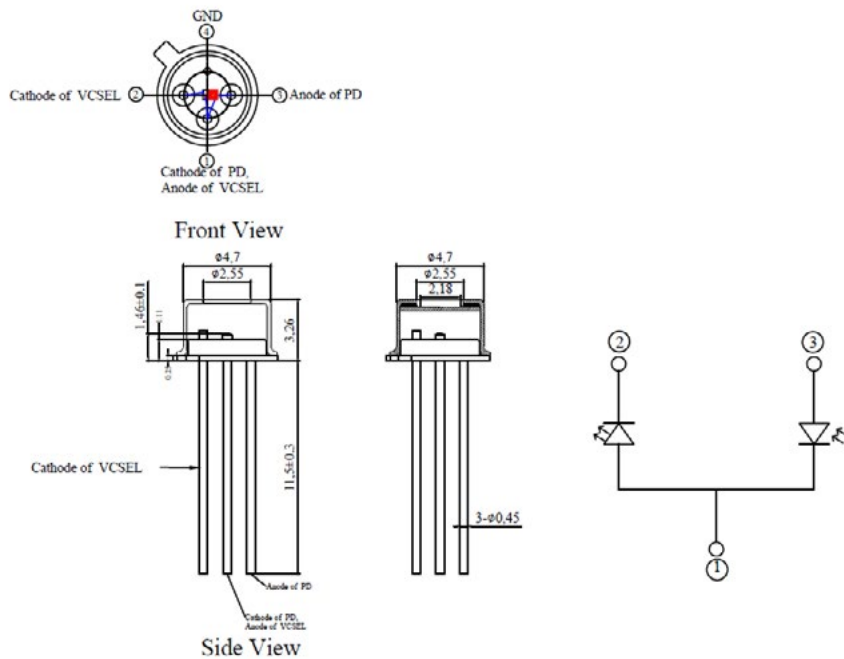

Note: There may be some changes between sample and drawing, thus, the actual spec please refer to the sample that you received. And if any question please contact us.

VI. SMT reflow soldering curve

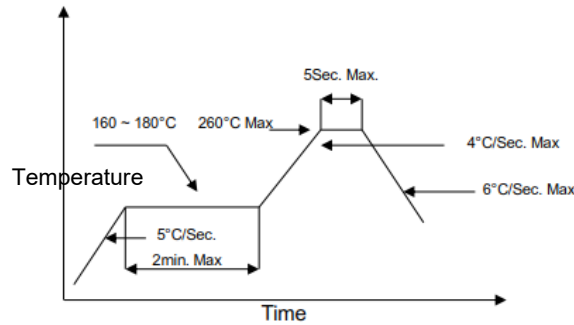

Note: Reflow soldering can be operated only one time. During the temperature ramp-up, no forces may be exerted on the VD which could deform or damage them. After soldering completed, please also do not process until the product temperature ramp down to room temperature.

VII. Treatment and protection measures

Soldering precautions

The temperature of soldering iron must be controlled under 300°C during manual soldering. Also, VCSEL can be only soldered one time with the soldering time less than 3s. It could be very hard to control the soldering temperature and homogenize solder paste because of the smaller size of VCSEL. In addition, it is easy to damage VCSEL structure even causes VCSEL losing efficacy. So, we advise you to use re-flow soldering machine for operation.

Storage precautions

Our products were sealed by aluminum foil bag attaching packed desiccant, they are moisture proof and anti-static. please handle these gently to avoid damage. At the same time, please be ready for storage and take some moisture-proof measures to keep VCSEL away from dampness that may causes reliability failure.

Before opening, VCSEL must be saved for at least 90 days below 30°C with 60%RH.

After opening, VCSEL must be kept in an environment that temperature lower than 30°C and humidity lower than 60%RH and used up within 24 hours. When the storage humidity reaches and exceeds 60%, the products must be dehumidified at 60°C for more than 24hours before use.

Others

1. Please use solder paste to cure the laser diode.
2. Please make sure that the heat of VD has been completely conducted to metal shell, to avoid affecting the optical power output.
3. This VD can be only used in constant voltage and current.
4. Operating voltage and current, refer to the table in paragraph II.
5. Please do not aim the laser to people or animal.
6. You can observe the laser spot through an image monitoring equipment.
7. Please do not touch VD surface by naked hands or squeeze the sealant on VD surface, or it may cause wrong optical angle and distorted laser spot, even damage the VD.
8. Please use ceramic suction nozzle to suck on the VD, so to avoid VD sticking to the nozzle.
9. Please add a 0.02s blowing action after locating the laser diode to aluminum substrate.

VIII. Revision history

Revision	Date	Description
V.01	2021/08/07	The first official edition (3C5,3C6)
V.02	2022/03/08	Update Mechanical Schematics
V.03	2022/07/04	Update TO46 package

**Brightlaser reserves the right to make modification at any time due to improved design from time to time, the merit behind is in order to supply the best product possible.

Laser diode product components are intended for use in a user-devised end system. However, these products are capable of emitting laser radiation. Extreme care must be exercised during their operation. Only persons familiar with the appropriate safety precautions should operate a laser product. Directly viewing the laser beam or exposure to specular reflections must be avoided. Serious injury may result if any part of the body is exposed to the beam. The eye is extremely sensitive to the infrared radiation and therefore, proper eye wear must be worn at all times. Use of optical instruments with these products may increase eye hazard. Always wear eye protection when operating.



Germany and Other Countries

Laser Components Germany GmbH
Tel: +49 8142 2864-0
Fax: +49 8142 2864-11
info@lasercomponents.com
www.lasercomponents.com

France

Laser Components S.A.S.
Tel: +33 1 39 59 52 25
Fax: +33 1 39 59 53 50
info@lasercomponents.fr
www.lasercomponents.fr

United Kingdom

Laser Components (UK) Ltd.
Tel: +44 1245 491 499
Fax: +44 1245 491 801
info@lasercomponents.co.uk
www.lasercomponents.co.uk

Nordic Countries

Laser Components Nordic AB
Tel: +46 31 703 71 73
Fax: +46 31 703 71 01
info@lasercomponents.se
www.lasercomponents.se

USA

Laser Components USA, Inc.
Tel: +1 603 821-7040
Fax: +1 603 821-7041
info@laser-components.com
www.laser-components.com