

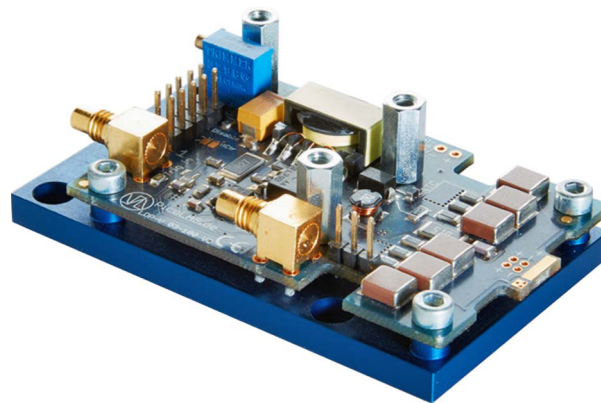

# User Manual

LDP-V 50-100 V3.3



Rev. 1908

## Table of Contents

Product Overview .....	3
How to get started .....	4
How to connect the LDP-V 50-100 .....	5
Operating Range Diagram.....	6
Maximum Duty Cycle vs. Output Current .....	8
Current Droop vs. Pulse Duration.....	8
Internal Structure of the LDP-V .....	9
How to use the internal HV-DC Supply .....	10
Pulse Output.....	10
Trigger Input .....	11
Trigger Output Monitor .....	11
Absolute Maximum Ratings.....	12
Mechanical Details of the Baseplate .....	12



## LDP-V 50-100 V3.3

### Driver Module for pulsed Lasers

Rev. 1908

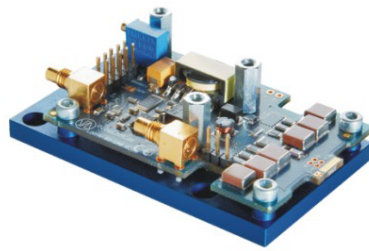

- Compact OEM module
- 3 to 50 A output current
- < 4 ns rise time
- Pulse width control via SMC trigger input (8 ns to 10  $\mu$ s)
- Rep. rates from single shot to 2 MHz
- Single supply
- Current monitor and isolated monitor
- Applications: LIDAR, Measurements, Ignition, Rangefinding, Biochemistry, ...

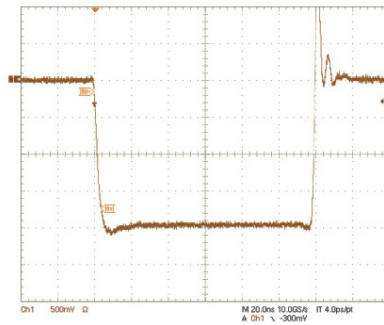

Figure: Current monitor output, scale: -10 A/Div

#### Technical Data\*

Output current	3 .. 50 A
Max. output voltage	100 V
- int. high voltage	0 .. 100 V, 1 A, 15 W
Rise time	Typ. 2.3 ns, max. 4 ns
Trigger delay	Typ. 36 ns, max. 40 ns
Min. pulse duration	8 ns
Max. pulse duration	> 1 $\mu$ s (@ 50 A)** > 10 $\mu$ s (@ 5 A)**
Trigger range	Single shot to 2 MHz** (refer to diagram with operating limits)
Trigger input	5 V into 50 $\Omega$ via SMC-jack
Trigger output	Galvanically isolated Rogowski coil
Current monitor	20 A/V into 50 $\Omega$
Supply voltage	15 .. 24 V, 2.2 A Optional: 0 .. 100 V, 30 W (external high voltage)
Max. power dissipation	25 W
Dimensions in mm	75 x 44 x 20
Weight	76 g
Operating temperature	-20 to +55 $^{\circ}$ C

\* Measured into a short instead of laser diode. Technical data is subject to change without further notice.

\*\* See manual for detailed information.



#### Product Description

The LDP-V 50-100 is a small and inexpensive source for generating nanosecond pulses. The device is optimized for pulse repetition rates from single shot up to MHz repetition rate with duty cycles up to 59%\*\*. Its typical application is driving pulsed laser diodes. Those can be mounted directly onto the LDP-V, eliminating the need for strip lines. The diode must be electrically isolated from earth (chassis) ground. Compatible laser diode packages: TO-18, TO-5, TO-52, 5.6 mm, 9 mm and similar. Despite its small size, the LDP-V is designed for ease of use. It eliminates the need for multiple peripheral supply units. A single 15 .. 24 V DC supply and a triggering signal are all which is required for operation. Additionally, you can upgrade the LDP-V with the PLCS-21 controller to enable USB 2.0 communication with a PC or the external operating unit PLB-21.

**Do not use PLCS-21 with higher supply voltage than 15 V. If you use the PLCS-21 with higher voltage than 15 V, the device will be damaged.**

Optional Accessories: PLCS-21  
PLB-21  
LDP-V BOB  
LDP-V KIT

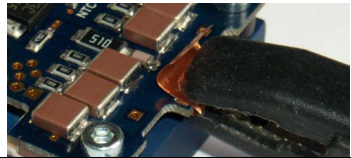
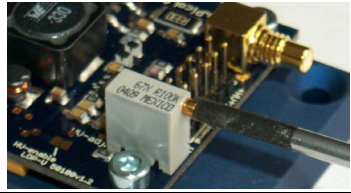
## How to get started

Step	What to do	Check
1	Unpack your device.	
2	Make a short at the output.	
3	Turn the high voltage to the lowest value (turn poti fully counterclockwise).	
4	Connect a pulse source with the desired pulse width to the selected triggering input.	E.g. 100 ns, 100 Hz repetition rate.
5	Connect your scope. There are two golden smc-connectors on the board (see page 5). The connector for the current monitor is the one closer to the output of the driver.	Select 50 Ohm termination, trig on neg. falling edge, 200 mV/div.
6	Apply the supply voltage. <b>Security advice:</b> Do not touch any leads of the output or the output capacitors as they are connected to a high voltage of up to 100 V.	Connect a 15 .. 24 V DC power supply to the pin header. See page 5 for details. <b>Note:</b> Some supplies have a voltage overshoot during turn on/turn off. This may damage the device.
7	Adjust the value of the desired pulse current. Measure the current by the current monitor as described in step 5 with an oscilloscope. If the oscilloscope is set 50 Ohm termination, the conversion factor is 20 A/V (turn the poti clockwise until the current reaches the desired level).	
8	Disconnect the supply, remove the short at the output and assemble the laser diode (polarity!).	
9	Reconnect the supply and check the optical output of your laser diode.	<b>Note:</b> The actual current is always some percent lower than the value of step 7. Adjust the current with help of the poti.

**Do not use PLCS-21 with higher supply voltage than 15 V. If you use the PLCS-21 with higher voltage than 15 V, the device will be damaged.**

## How to connect the LDP-V 50-100

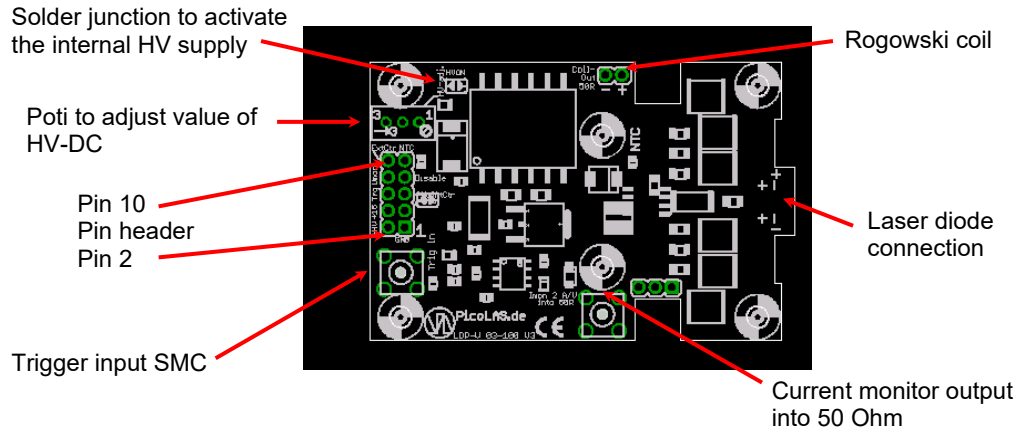

### Connections via Pin header:

Pin	Name	Description
1	GND	Ground return
2	HV+	External high voltage supply input (0 .. 100 V) for connecting an alternative HV-DC supply. See page 9 for details.
3	GND	Ground return
4	+15 V	Supply Voltage 15 .. 24 V, connect to a power supply.
5*	Disable_Poti	Disables the internal HV setpoint poti when set high.
6	Pulse_In	Trigger input into 50 Ohm
7	Disable	Disables the Pulser when set high.
8*	U-Monitor	High-voltage monitor output (scale: 40 mV/V) for supervising the actual high voltage.
9	NTC	Internal 10 kOhm NTC versus GND for temperature monitoring. (B-value: 3620)
10*	Ext_HV_Setpoint	External HV setpoint input (scale: 25 V/V) allows control over the internal HV-DC source.

\*These pins had to be left unconnected in older versions than V3

#### Trigger Input:

The trigger input requires a signal level of 5 V and is terminated with 50 Ohm.

#### Current Monitor Output:

The current monitor output has a scale of 20 A/V with a negative signal output. It has a source impedance of 50 Ohm and must be terminated with 50 Ohm to achieve the correct scale.

**Laser Diode Connection:**

The laser diode can either be connected via the mounting holes on the top side of the pulser (inner hole: Anode, outer hole: Cathode) or at the rectangular pads on top (Anode) and bottom (Cathode) of the pulser.

**Security Advice:** Do not touch any leads of the output or the output capacitors as they are connected to a high voltage of up to 100 V.

**Do not use PLCS-21 with higher supply voltage than 15 V.**  
**If you use the PLCS-21 with higher voltage than 15 V, the device will be damaged.**

**Operating Range Diagram**

LDP-V 50-100 V3: Max. Reprate vs. Pulsewidth (internal HV, with cooling)

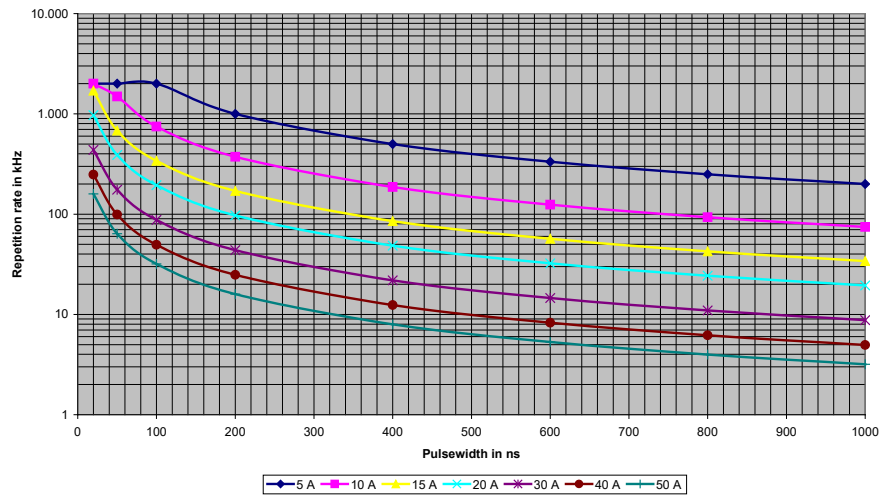

LDP-V 50-100 V3: Max. Reprate vs. Pulsewidth (internal HV, without cooling)

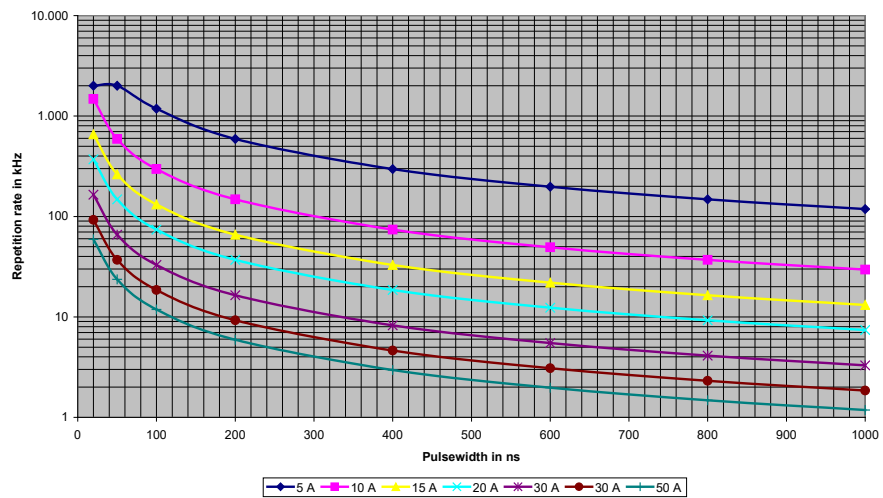



LDP-V 50-100 V3: Max. Reprate vs. Pulsewidth (external HV, with cooling)

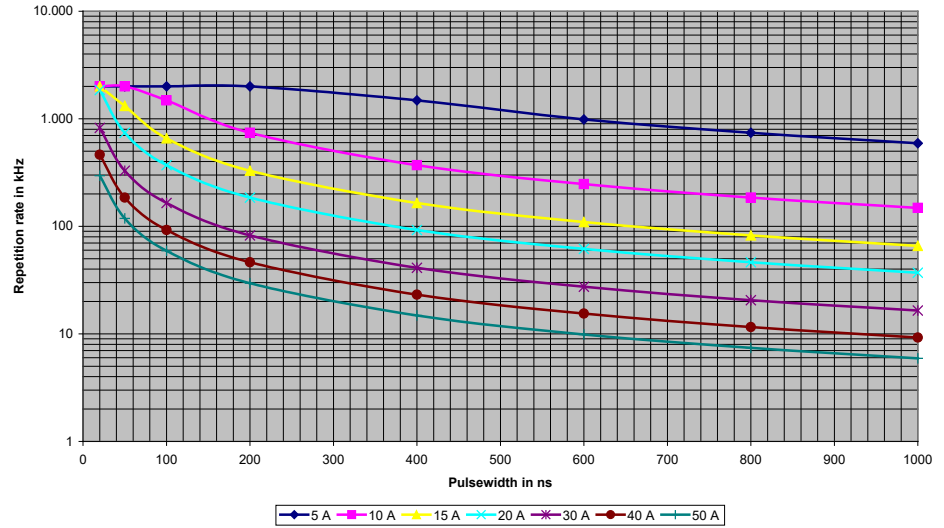

LDP-V 50-100 V3: Max. Reprate vs. Pulsewidth (external HV, without cooling)

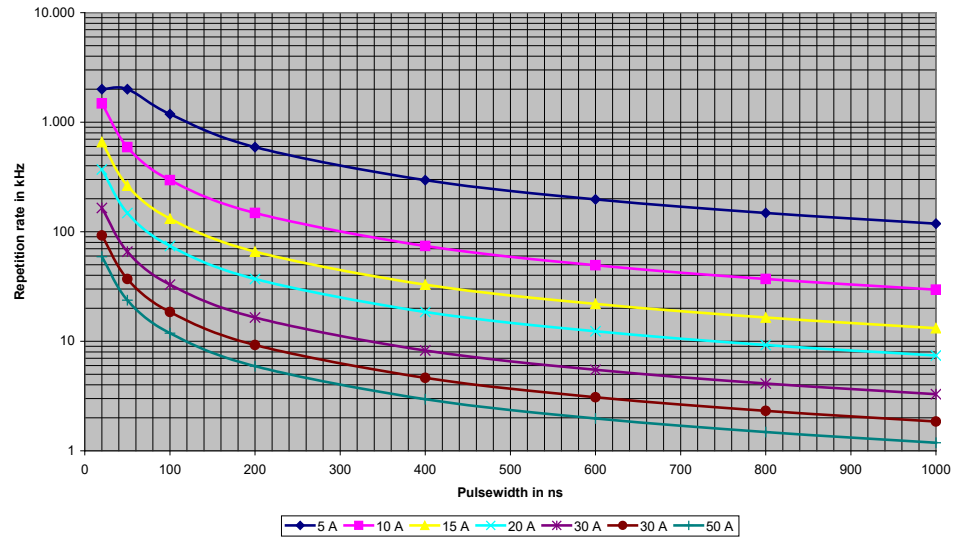

## Maximum Duty Cycle vs. Output Current

The following tables show the maximum allowable duty cycle depending on a given output current.

With active cooling of the baseplate:

Output current in A	Max. duty cycle with ext. HV	Typical high voltage in V	Max. duty cycle with int. HV
5	0.5926	10.9	0.2000
10	0.1481	20.1	0.0746
15	0.0658	29.4	0.0341
20	0.0370	38.6	0.0194
30	0.0165	57.1	0.0088
40	0.0093	75.6	0.0050
50	0.0059	94.1	0.0032

Without cooling of the baseplate:

Output current in A	Max. duty cycle with ext. HV	Typical high voltage in V	Max. duty cycle with int. HV
5	0.1185	10.9	0.1185
10	0.0296	20.1	0.0296
15	0.0132	29.4	0.0132
20	0.0074	38.6	0.0074
30	0.0033	57.1	0.0033
40	0.0019	75.6	0.0019
50	0.0012	94.1	0.0012

## Current Droop vs. Pulse Duration

The following table shows the absolute output current droop (in A) versus pulse length. Pulse durations shorter than one microsecond are not considered as the droop is typically lower than 5%.

Current in A	Pulse duration in $\mu$ s		
	1	5	10
5	0.12	0.36	0.6
15	0.4	1.2	2.0
30	1.0	3.0	6.0
50	2.0	6.0	12.0



## Internal Structure of the LDP-V

The LDP-V series generates the pulses by a simple but efficient principle. First, the storage capacitors ( $C_s$ ) are charged, whether through the internal HV-DC supply or an external high voltage source. When a pulse is applied at the trigger input the high speed mosfet opens and the current flows from the capacitor through the laser diode, mosfet and current sense resistors. At the end of the pulse the mosfet closes again and the current stops. The generated current depends on the applied high voltage, the laser diode compliance voltage and its differential resistance.

The following formula gives a good estimation of the laser diode current depending on the pulser's high voltage supply  $U_{HV}$ , the laser diode compliance voltage  $U_{comp}$  and its differential resistance  $R_{diff}$ :

$$I_{LD} \approx \frac{U_{HV} - U_{comp}}{1.6 + R_{diff}}$$

The laser diode current is measured with current sensing resistors (current monitor output) and with the galvanically isolated Rogowski coil. Disable and trigger input provide full control of the driver's pulsing capability to the user. The required DC high voltage can either be applied through an external voltage source or it can be generated with the integrated HV-DC supply. The internal supply is controlled by the HV setpoint poti or, when the Disable\_Poti (pin 5) pin is set high, via the Ext\_HV\_setpoint (pin 10) pin. A voltage monitor (pin 8) provides feedback of the high DC voltage.

The Diode  $D_{RP}$  prevents the laser diode from reverse currents; a 10kR NTC provides the possibility to monitor the pulser temperature. An overtemperature protection is NOT integrated on the driver.

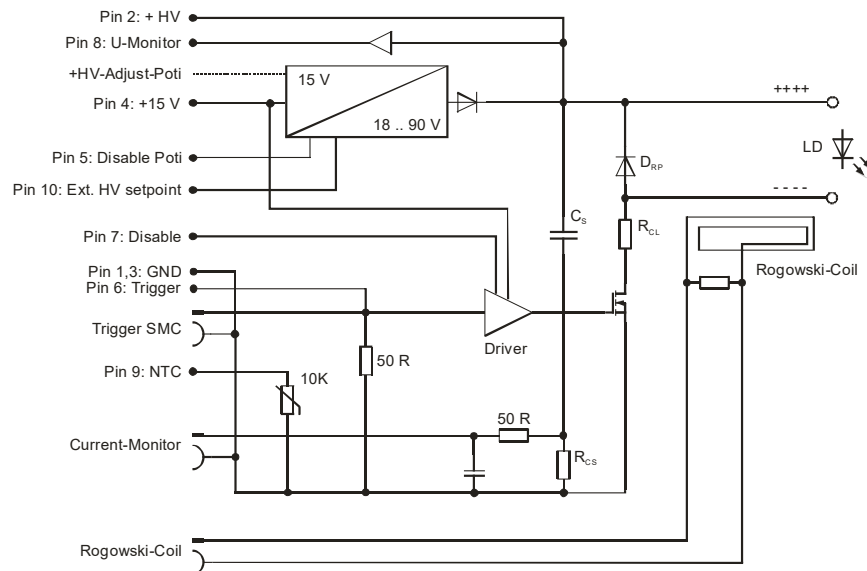

## How to use the internal HV-DC Supply

The LDP-V series provides a high power (up to 15 W / 1 A / 100 V) internal high voltage supply. To adjust the laser diode current to the desired value follow the steps below.

**Note:** Make sure that the solder junction is done to activate the HV-DC supply.

1. Turn the poti fully counterclockwise
2. Apply the 15 .. 24 V supply voltage
3. Start pulses
4. Measure the diode current
5. Adjust the level of the high voltage supply (hence the level of the current) by turning the poti clockwise

Since version 3 of the LDP-V series, the HV-DC supply can also be controlled through an external setpoint signal on pin 10 of the pin header (Ext\_HV\_Setpoint); the scale is 25V/V. To enable the external setpoint pin and disable the internal poti, pin 5 (Disable\_Poti) of the pin header has to be set to "high". Otherwise the internal poti will override the external signal. The high DC voltage can be monitored at pin 8 (U-Monitor) with a scale of 40 mV/V.

**Note:** Older versions are not capable of these features and the above mentioned pins have to be left unconnected!

### Security Advice:

Do not touch any leads of the output or the output capacitors as they are connected to a high voltage of up to 100 V.

## Pulse Output

The LDP-V series provides ultra rapid pulse rise- and falltimes in the region of several nanoseconds. However, pulse rise and fall depend on the parasitic stray inductance of the cabling to the laser diode. Direct connection without any kind of wires to the module is absolutely necessary for best results. For detailed information about the effect of the laser diode connection on the pulse shape please refer to PicoLAS Application Notes "Impedance of Diodes" and "LD-Connections".

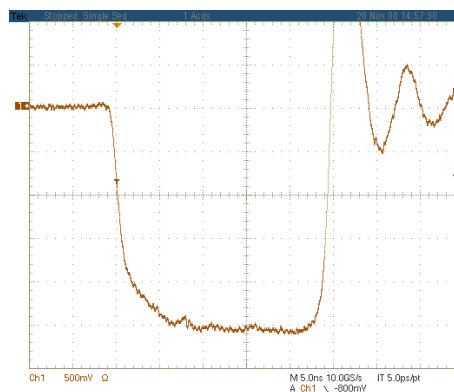

Typical Pulse Rise- and Falltimes of LDP-V 50-100 (scale: 10 A/Div)

## Trigger Input

The trigger input, both on the pin header and the SMC jacket, is terminated with 50 Ohm to ground. The trigger source has to be able to provide a signal level of 5 V with a 50 Ohm load.

The delay between the triggering signal and the load current is very low around 36 ns and very constant. The pulse-to-pulse jitter is very stable below 1 ns if the supply voltage and temperature are kept constant.

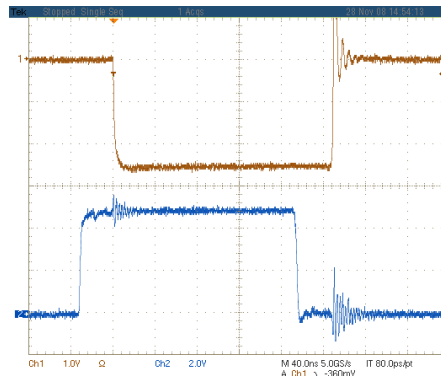

Typical trigger delay of LDP-V 50-100

## Trigger Output Monitor

The trigger output signal is generated with an integrated, isolated Rogowski coil and provides an ultra fast galvanically isolated signal. The signal shape is proportional to the derivative of the load current. It can be used for a current response triggering signal and has no delay to the load current. Combined with an integrator it is possible to use this signal for a galvanically isolated current monitor. The isolation barrier is suitable for voltages up to 100 V and prevents unwanted ground loops.

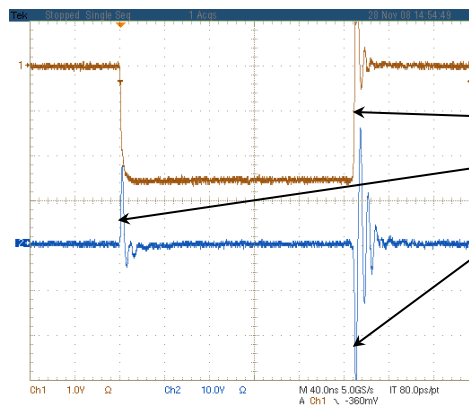

Signal of the Rogowski coil:

"True" load current

Positive edge at pulse begin

Negative edge at pulse end

