

AlGaInP / APC Visible Laser Diode

ADL-63054TA4

T6-2D-LD63-014 Rev.00

635nm 5mW LD

By converting the external APC circuit board into an ASIC, we package the APC circuit into a traditional TO-can together with the laser chip. From now on, single package APC function included laser diode is realized. Powered with Arima's proprietary APC **LASER DIODE™** technology, **ADL-63054TA4** is your perfect solution for the stable light power output, compact size, high brightness laser light source.

APC LASER DIODE™ v.4

Features

1. 635nm 5mW 50°C high reliable operation
2. Saving space and cost of laser module
3. Voltage driven LD, easy to use
4. Highly stable laser output power
5. Strong reverse bias protection
6. Reliable high temperature operation
7. High ESD sustainability voltage, ~10KV
8. Broad bandwidth from blue to infrared
9. High power operation vs. supply current up to 300mA
10. Stable output power vs. supply voltage from 2.5V to 6.0V.
11. Light-fuse: automatic shutdown when output power over the limit

Applications

1. High precision measuring instruments
2. High precision industrial makers
3. Survey and engineering instruments

Absolute maximum ratings

Parameter	Symbol	Rating	Unit
Power supply voltage	V_{cc}	2.5~6.0	V
Laser optical output power	P_o	7.0	mW
Operation temperature	T_{opr}	-10 ~ +50	°C
Storage temperature	T_{stg}	-40 ~ +85	°C

Electrical and optical characteristics ($T_c=25^\circ\text{C}$)

Parameter	Symbol	Min.	Typ.	Max.	Unit	Conditions
Wavelength	λ	630	635	640	nm	$P_o=5\text{mW}$
Operation current	I_{op}	-	32	45	mA	$P_o=5\text{mW}$
Variable resistor	VR	3	7	18	K Ω	$V_{cc}=3\text{V}$
Parallel divergence angle	$\theta_{ }$	6	8	12	Deg	$P_o=5\text{mW}$
Perpendicular divergence angle	θ_{\perp}	30	33	40	Deg	
Parallel FFP deviation angle	$\Delta\theta_{ }$	-3.0	0	+3.0	Deg	
Perpendicular FFP deviation angle	$\Delta\theta_{\perp}$	-3.0	0	+3.0	Deg	
Emission point accuracy	$\Delta x \Delta y \Delta z$	-80	0	+80	μm	-
Power-Temp stability (25~50°C)	ΔP_{oT}	-20	-10	0	%	$P_o=5\text{mW}, V_{cc}=3.0\text{V}$
Power-Vcc stability (6.0~3.0V)	ΔP_{oV}	-15	-10	0	%	$P_o=5\text{mW}, \text{Temp}=25^\circ\text{C}$
Power-Vcc stability (3.0~2.5V)	ΔP_{oV}	-15	-10	0	%	$P_o=5\text{mW}, \text{Temp}=25^\circ\text{C}$

* Effective heat sink is recommended on 6V case due to extra heat

For reference only. Contents above are subject to change without notice.

AlGaInP | APC Visible Laser Diode

ADL-63054TA4

T6-2D-LD63-014 Rev.00

635nm 5mW LD

Block Diagram:

1. Traditional LD needs to connect an external APC circuit board for the constant power operation. The VR (variable resistor) is used to adjust the laser output to a desired target power.
2. **ADL-63054TA4** consists an APC IC inside the **TO-5.6mm** package, and leaves the VR outside for adjusting the optical output power.
3. Oscillation Damper is recommended for stabilizing the optical output power.
4. Battery reverse protection is recommended for protecting the APC Circuit.

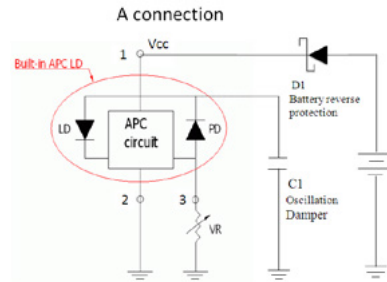

1. Vcc
2. GND
3. VR

Outline Dimension & Pin Assignment:

1. Vcc
2. GND
3. VR

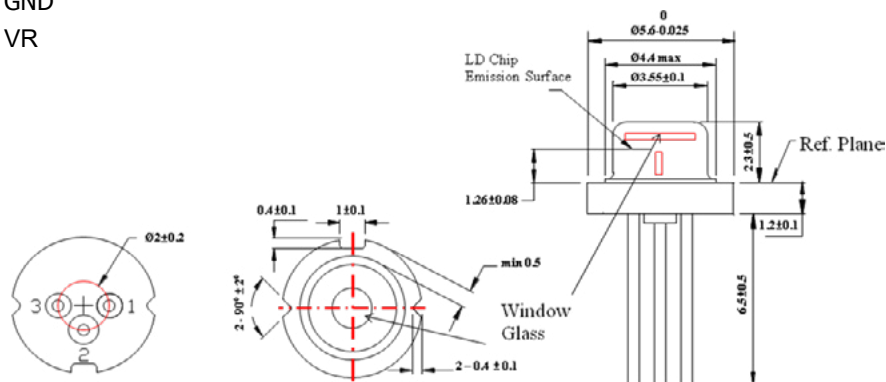

• Precautions

- To protect laser from overdriving condition, setting VR to maximum value before you turn on Vcc can minimized the laser output power.
- Do not operate the device above the maximum rating condition, even momentarily. It may cause unexpected permanent damage to the device.
- Semiconductor laser device is very sensitive to electrostatic discharge. High voltage spike current may change the characteristics of the device, or malfunction at any time during its service period. Therefore, proper measures for preventing electrostatic discharge are strongly recommended.
- To obtain a stable characteristic and good reliability, the effective heat sink is necessary. So it is recommended that always apply proper heat sink before the device is operating.
- Do not look into the laser beam directly by bare eyes. The laser beam may cause severe damage to human eyes.

For reference only. Contents above are subject to change without notice.