

## iC-WKM

### M-TYPE CW LASER DIODE DRIVER

Rev C2, Page 1/12

#### FEATURES

- ◆ Optimised for M-type laser diodes (single supply, case grounded)
- ◆ CW operation up to 350 mA from a single supply of 3.6 to 15 V
- ◆ Rapid soft start after power-on
- ◆ Simple power adjustment via an external resistor
- ◆ Integrated reverse polarity protection for the iC and laser diode
- ◆ Strong suppression of transients with small external capacitors; integrated flyback path
- ◆ Permanent shutdown with excessive temperature and overcurrent (i.e. if the laser diode is damaged or the feedback current path fails)
- ◆ Two feedback inputs permit all current laser diode types to be used (M/P/N configurations)
- ◆ Modulation via the feedback inputs possible
- ◆ Wide monitor current range from 2.5  $\mu$ A to 6.25 mA

#### APPLICATIONS

- ◆ Blue laser diodes
- ◆ Laser diode modules
- ◆ Laser diode pointers
- ◆ Laser levels
- ◆ Bar-code readers

#### PACKAGES

 SO8  
thermal pad

 DFN10  
4 mm x 4 mm

#### BLOCK DIAGRAM

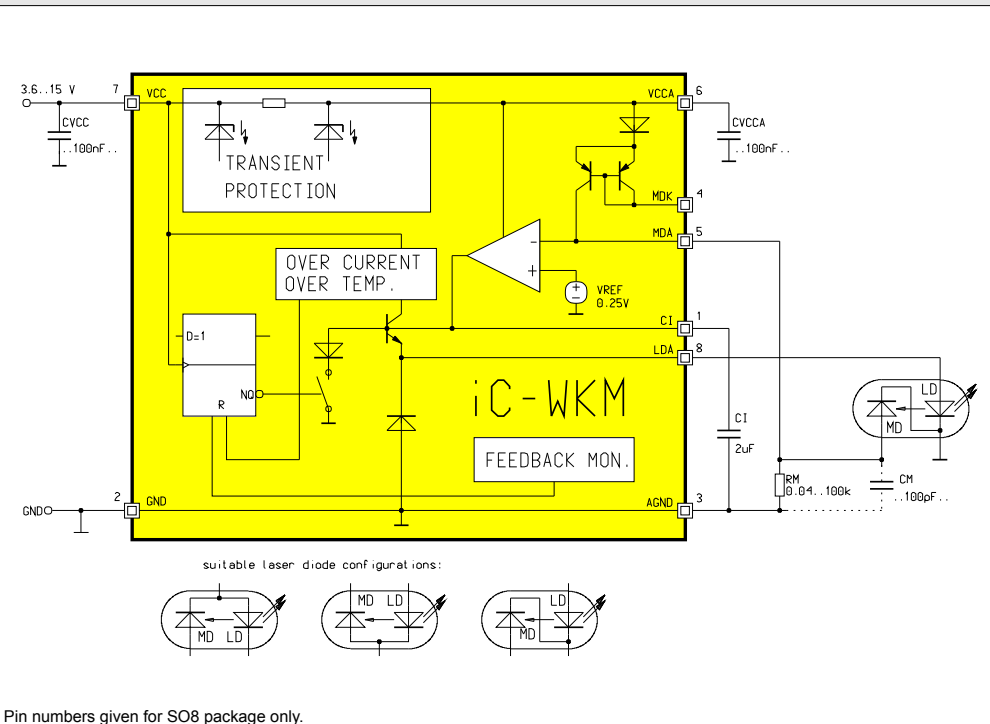

Copyright © 2004, 2015 iC-Haus

## iC-WKM

### M-TYPE CW LASER DIODE DRIVER

Rev C2, Page 2/12

#### DESCRIPTION

iC-WKM is a driver for laser diodes in continuous wave operation with laser currents of up to 350 mA, which requires only four external components. The wide power supply range of up to 15 V allows for operation of blue laser diodes, e.g. by Nichia or Sanyo. The driver is optimised for M-type laser diodes and allows the operation from a single supply and the connection of the laser diode case (common cathode) with ground.

The iC includes integrated circuitry protecting against destruction by ESD, excessive temperature and overcurrent plus a soft start of the regulator to protect the laser diode when the power supply is switched on. The iC also filters the laser diode power supply for transients.

The regulator is adapted to the laser diode by an external resistor at MDA. The monitor current acts as a reference and is regulated independent of the

influence of temperature and supply voltage (range: 2.5  $\mu$ A to 6.25 mA). The capacitor at CI determines the control time constants and start-up time.

A second monitor input, pin MDK, allows the driver to be used for P-type laser diode configuration; alternatively, it can be used as an analogue modulation input (DC to a few kHz).

In the event of failure, such as overcurrent in the laser path with a lack of feedback, for example, a quick power lockout is activated. The shutdown persists until power is reapplied, permitting a restart. The strain on power packs and batteries is relieved and the laser class is retained even in the event of a disturbance.

iC-WKM offers additional protection by means of spike detection at pin MDA. Should spikes or oscillation occur at pin MDA the power lockout is activated after a certain time-out.

# iC-WKM

## M-TYPE CW LASER DIODE DRIVER

Rev C2, Page 3/12

### PACKAGING INFORMATION SO8-TP, DFN10 4 mm x 4 mm to JEDEC standard

#### PIN CONFIGURATION SO8-TP

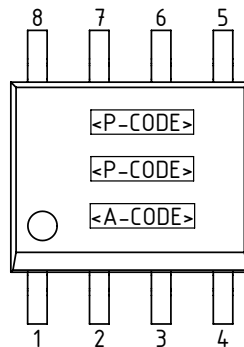

#### PIN FUNCTIONS

| No. | Name | Function                                    |
|-----|------|---|
| 1   | CI   | Capacitor for Power Control                 |
| 2   | GND  | Ground                                      |
| 3   | AGND | Reference Ground for CI, RM                 |
| 4   | MDK  | Monitor Input 2<br>(MD Cathode, modulation) |
| 5   | MDA  | APC Setup, Monitor Input 1<br>(MD Anode)    |
| 6   | VCCA | Driver Supply                               |
| 7   | VCC  | +3.6 to 15 V Supply Voltage                 |
| 8   | LDA  | Driver Output (LD Anode)                    |

The *Thermal Pad* is to be connected to a Ground Plane on the PCB. Do not short-circuit pins AGND and GND, for this may deteriorate the precision of the regulator and interfere with the soft-start!

#### PIN CONFIGURATION DFN10 4 mm x 4 mm

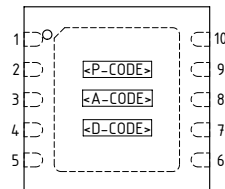

#### PIN FUNCTIONS

| No. | Name | Function                                    |
|-----|------|---|
| 1   | CI   | Capacitor for Power Control                 |
| 2   | GND  | Ground                                      |
| 3   | AGND | Reference Ground for CI, RM                 |
| 4   | MDK  | Monitor Input 2<br>(MD Cathode, modulation) |
| 5   | n.c. |   |
| 6   | MDA  | APC Setup, Monitor Input 1<br>(MD Anode)    |
| 7   | VCCA | Driver Supply                               |
| 8   | VCC  | +3.6 to 15 V Supply Voltage                 |
| 9   | LDA  | Driver Output (LD Anode)                    |
| 10  | n.c. |   |

The *Thermal Pad* is to be connected to a Ground Plane on the PCB. Do not short-circuit pins AGND and GND, for this may deteriorate the precision of the regulator and interfere with the soft-start!

# iC-WKM

## M-TYPE CW LASER DIODE DRIVER

Rev C2, Page 4/12

### PACKAGE DIMENSIONS SO8-TP

SIDE

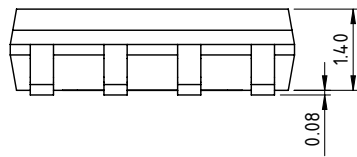

FRONT

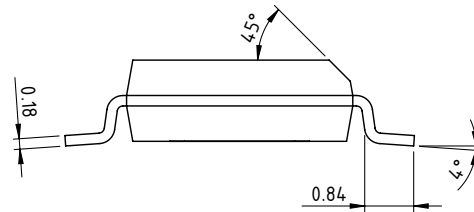

TOP

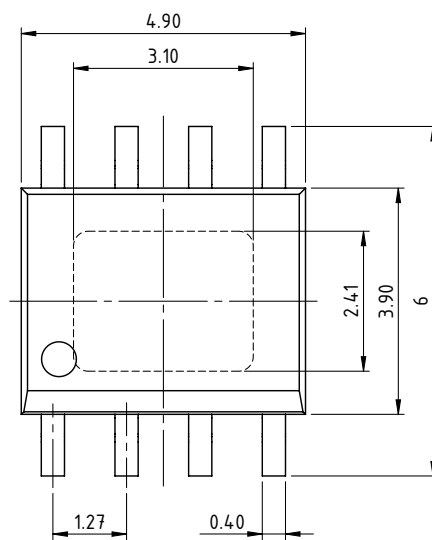

RECOMMENDED PCB-FOOTPRINT

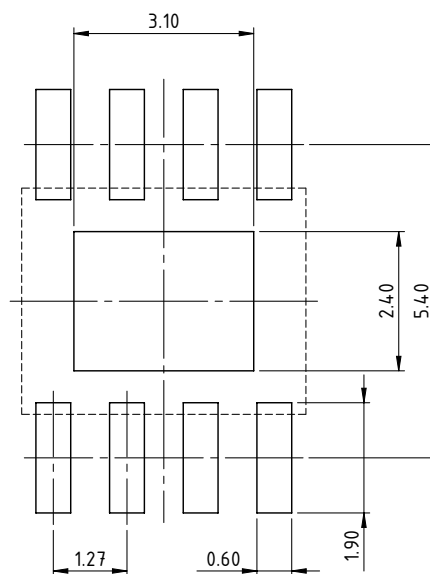

All dimensions given in mm. Tolerances of form and position according to JEDEC MS-012

drb\_so8-tp-1\_pack\_1, 10:1

# iC-WKM

## M-TYPE CW LASER DIODE DRIVER

Rev C2, Page 5/12

### PACKAGE DIMENSIONS DFN10 4 mm x 4 mm

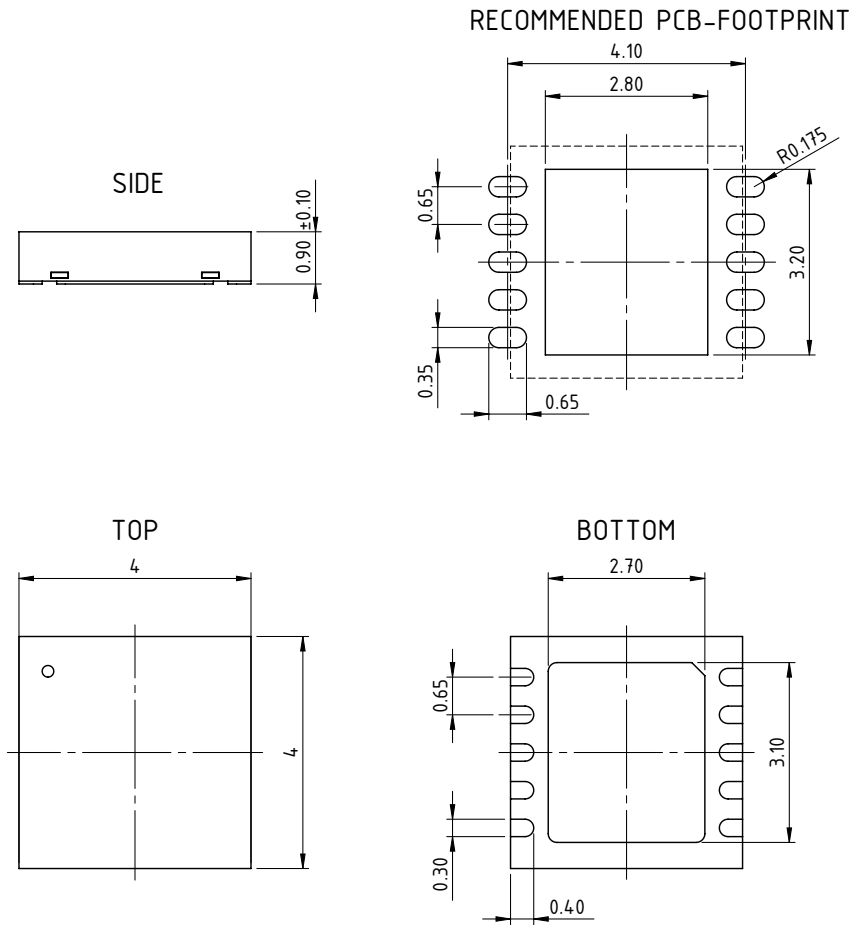

All dimensions given in mm.  
Tolerances of form and position according to JEDEC MO-229.

drc\_dfn10-4x4-1\_pack\_1, 10:1

# iC-WKM

## M-TYPE CW LASER DIODE DRIVER

Rev C2, Page 6/12

### ABSOLUTE MAXIMUM RATINGS

Beyond these values damage may occur; device operation is not guaranteed.

| Item No. | Symbol  | Parameter                      | Conditions                            |      |      | Unit |
|----------|---------|--------------------------------|---------------------------------------|------|------|------|
|          |         |                                |                                       | Min. | Max. |      |
| G001     | VCC     | Voltage at VCC                 |                                       | -6   | 16   | V    |
| G002     | I(VCC)  | Current in VCC                 |                                       | -10  | 900  | mA   |
| G003     | I(CI)   | Current in CI                  |                                       | -10  | 10   | mA   |
| G004     | I(LDA)  | Current in LDA                 |                                       | -900 | 10   | mA   |
| G005     | I(VCCA) | Current in VCCA                |                                       | -10  | 10   | mA   |
| G006     | I(MDA)  | Current in MDA                 |                                       | -10  | 10   | mA   |
| G007     | I(MDK)  | Current in MDK                 |                                       | -10  | 10   | mA   |
| G008     | I(AGND) | Current in AGND                |                                       | -10  | 10   | mA   |
| G009     | I(GND)  | Current in GND                 |                                       | -10  | 900  | mA   |
| G010     | Vd()    | ESD Susceptibility at all pins | HBM, 100 pF discharged through 1.5 kΩ |      | 2    | kV   |
| G011     | Tj      | Operating Junction Temperature |                                       | -40  | 150  | °C   |
| G012     | Ts      | Storage Temperature Range      |                                       | -40  | 150  | °C   |

### THERMAL DATA

Operating Conditions: VCC = 3.6...15V

| Item No. | Symbol | Parameter                           | Conditions  |      |      |      | Unit |
|----------|--------|-------------------------------------|---|------|------|------|------|
|          |        |                                     |   | Min. | Typ. | Max. |      |
| T01      | Ta     | Operating Ambient Temperature Range |   | -40  |      | 85   | °C   |
| T02      | Rthja  | Thermal Resistance Chip/Ambient     | SMD assembly, no additional cooling areas                     |      |      | 170  | K/W  |
| T03      | Rthja  | Thermal Resistance Chip/Ambient     | therm. pad soldered to approx. 2 cm <sup>2</sup> cooling area |      | 30   | 50   | K/W  |

All voltages are referenced to ground unless otherwise stated.  
 All currents flowing into the device pins are positive; all currents flowing out of the device pins are negative.

# iC-WKM

## M-TYPE CW LASER DIODE DRIVER

Rev C2, Page 7/12

### ELECTRICAL CHARACTERISTICS

Operating Conditions: VCC = 3.6...15V, RM = 40 Ω...100 kΩ, Tj = -40...125 °C unless otherwise noted

| Item No.   | Symbol    | Parameter   | Conditions  | Min.                 | Typ. | Max.                 | Unit   |
|--|-----------|---|---|----------------------|------|----------------------|--------|
| <b>Total Device</b>                                |           |   |   |                      |      |                      |        |
| 001  | VCC       | Permissible Supply Voltage                          |   | 3.6                  |      | 15                   | V      |
| 002  | I(LDA)m   | Permissible Laser Drive Current                     | control range   | -350                 |      | -10                  | mA     |
| 003  | Idc(VCC)  | Supply Current without load path                    | closed control loop, I(MDK) = 0, I(LDA) = 350 mA                    |                      | 5    | 10                   | mA     |
| 004  | Ioff(VCC) | Supply Current after Reset                          |   |                      | 2.4  | 5                    | mA     |
| 005  | Ir(VCC)   | Reverse Supply Current                              | RM = 50 kΩ, VCC = -6 V  | -10                  | -3   |                      | mA     |
| 006  | ton()     | Turn-on Delay                                       | VCC: 0 → 5V to 95%I(LDA); I(LDA) = I(LDA)m, CI = 3.3 μF             |                      |      | 600                  | μs     |
| 007  | Vc(j)hi   | Clamp Voltage hi at MDA                             | I() = 10 mA, other pins open  | 1.1                  |      | 4                    | V      |
| 008  | Vc(j)lo   | Clamp Voltage lo at VCC, LDA, MDA, CI, VCCA         | I() = -10 mA, other pins open                                       | -9                   |      |                      | V      |
| 009  | Vc(j)hi   | Clamp Voltage hi at MDK referenced to VCCA          | I() = 10 mA, other pins open  | 6                    |      | 11                   | V      |
| 010  | Vc(j)lo   | Clamp Voltage lo at MDK referenced to VCCA          | I() = -10 mA, other pins open                                       | -11                  |      | -1                   | V      |
| 011  | Vc(j)hi   | Clamp Voltage hi at VCC, LDA, CI, VCCA              | I() = 10 mA, other pins open  | 16                   |      | 24                   | V      |
| <b>Reference and Monitor Inputs MDA, MDK, AGND</b> |           |   |   |                      |      |                      |        |
| 101  | V(MDA)    | Reference Voltage at MDA                            | closed control loop, V(LDA) < Vs(LDA)                               | 230                  | 250  | 270                  | mV     |
| 102  | dV(MDA)   | Reference Voltage Temperature Drift at MDA          | see 101   |                      |      | 120                  | μV/°C  |
| 103  | Ierr(MDA) | Input Current in MDA                                | closed control loop, I(MDK) = 0                                     | -100                 |      | 100                  | nA     |
| 104  | di(MDA)   | Input Current Temperature Drift in MDA              | see 103   | -1                   |      | 1                    | nA/°C  |
| 105  | APCerr    | Control Error                                       | RM = 10 kΩ;<br>Tj = 0...80 °C<br>Tj = -40...125 °C                  |                      |      | 0.5<br>2             | %<br>% |
| 106  | di(MD)    | Supply Voltage Suppression                          | V(VCC): 3.6V → 15V, I(LDA) = -350 mA                                | -4                   |      | 4                    | %      |
| 107  | Rgnd()    | Resistor AGND-GND                                   |   |                      |      | 3                    | Ω      |
| 108  | CR()      | Current Ratio I(MDA)/I(MDK)                         | I(MDK) = 1...500 μA<br>I(MDK) = 0.5...3 mA<br>I(MDK) = 3...6 mA     | 0.97<br>0.95<br>0.92 |      | 1.03<br>1.05<br>1.06 |        |
| 109  | TC()      | Current Ratio Temperature Coefficient I(MDA)/I(MDK) | I(MDK) = 1 μA...1 mA  | -0.005               |      | 0.005                | %/°C   |
| 110  | TC()      | Current Ratio Temperature Coefficient I(MDA)/I(MDK) | I(MDK) = 1...6 mA   | -0.025               |      | 0.025                | %/°C   |
| 111  | Vf(MDK)   | Voltage at MDK                                      | Vf() = V(VCCA) - V(MDK), I(MDK) = 1 μA...6 mA                       | 0.4                  |      | 2                    | V      |
| <b>Laser Driver LDA</b>                            |           |   |   |                      |      |                      |        |
| 201  | Vs(LDA)   | Saturation Voltage at LDA referenced to VCC         | Vs(LDA) = V(VCC) - V(LDA); I(LDA) = -40 mA<br>I(LDA) = -350 mA      |                      |      | 1.0<br>1.5           | V<br>V |
| 202  | di(MDA)   | Load Balancing Error                                | I(LDA): -20 → -350 mA   | -5                   |      | 4                    | %      |
| 203  | It(LDA)   | Overcurrent Threshold in LDA                        |   | -700                 |      | -360                 | mA     |
| 204  | toff()    | Overcurrent Reset Delay                             | lack of feedback: I(MD) = 0 to I(LDA) > -10 mA, VCC = 5V, CI = 1 μF |                      |      | 600                  | μs     |
| 205  | Vf()      | Flyback Diode Forward Voltage V(GND)-V(LDA)         | I(LDA) > -350 mA  |                      |      | 1.5                  | V      |
| 206  | Rvcc()    | Transient Protection Resistor                       | VCC to VCCA   |                      |      | 3                    | Ω      |
| 207  | Vt(MDA)   | Shutdown Threshold at MDA                           | t > 1 μs  | 0.7                  |      | 1.8                  | V      |

# iC-WKM

## M-TYPE CW LASER DIODE DRIVER

Rev C2, Page 8/12

### ELECTRICAL CHARACTERISTICS

Operating Conditions: VCC = 3.6...15V, RM = 40Ω...100kΩ, Tj = -40...125 °C unless otherwise noted

| Item No.                         | Symbol | Parameter                          | Conditions | Min. | Typ. | Max. | Unit |
|----------------------------------|--------|------------------------------------|------------|------|------|------|------|
| <b>Control Release Flip-Flop</b> |        |                                    |            |      |      |      |      |
| 301                              | VCCen  | Set Threshold for Enable Flip-Flop |            | 0.6  |      | 1.9  | V    |
| 302                              | Toff   | Overtemperature Shutdown           |            | 140  |      | 165  | °C   |



# iC-WKM

## M-TYPE CW LASER DIODE DRIVER

Rev C2, Page 9/12

### SAFETY INSTRUCTIONS

**Laser light can damage the human eye and the eyes of animals!** Do not look at any laser light directly or through any optical lens. When handling a laser diode, do not look directly at the light generated by it. Wear appropriate safety glasses to prevent light from entering the eye even by reflection.



### FUNCTION DESCRIPTION

#### Setting the output power

The output power is simply set by  $RM = V(MDA) / I(MD)$ ; with  $V(MDA) = \text{Item-No. 101}$  and  $I(MD) = \text{monitor current of the laser diode at the desired operating point}$ .  $RM$  should be combined from fixed resistor (max. output power) and a trimmer (calibration).

If the voltage drops below this value, the output stage is forcibly saturated and the laser current decreases. iC-WKM simultaneously discharges the control capacitor  $CI$  so that no excessive laser diode currents occur when the supply voltage rises again.

#### Turn-on behaviour

After switching the supply voltage on, the output stage remains disabled until the internal enabling flip-flop is set by a sufficiently high voltage at  $VCC$ .

A quick soft start follows; the transition to controlled CW operation is gradual and primarily determined by the values of  $CI$  and  $RM$ .  $CI$  is properly dimensioned when the voltage overshoot at  $MDA$  is at a minimum.

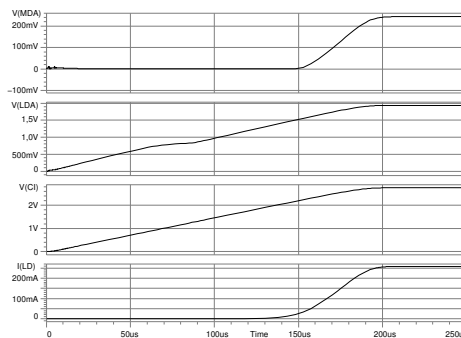

Figure 1: Turn-on behaviour

#### Turn-off behaviour

iC-WKM works without a fixed undervoltage lockout, thus the laser diode forward voltage is the prime factor determining the lowest possible supply voltage.

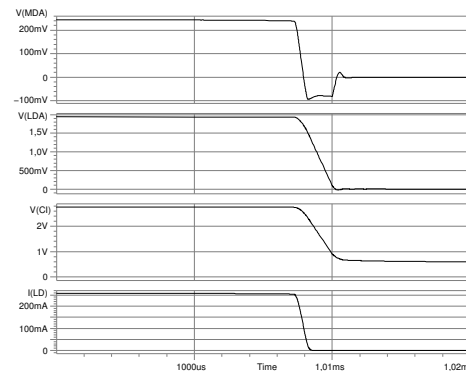

Figure 2: Turn-off behaviour

#### Disruptions in operation

The power control is shut down with excessive driver temperature or when the laser current reaches the over-current shutdown threshold, for example when the feedback is interrupted. If the monitor diode or the bias resistor  $RM$  fail, the device is shut down in less than 600  $\mu s$ , provided that the supply voltage applied is high enough.

When modulating the laser current via pin  $MDK$ , excessive voltage occurring at pin  $MDA$  also may cause a shutdown.

## iC-WKM M-TYPE CW LASER DIODE DRIVER

Rev C2, Page 10/12

### APPLICATION NOTES

#### Laser diode types

In principle, all three laser diode types can be operated by iC-WKM.

As iC-WKM has been optimised for use with **M-type** laser diodes, it is with this type of diode that the best functionality is achieved. This type of setup also enables the laser diode package to be connected to GND.

With **P-type** laser diodes it is also possible to connect the laser diode package to GND. Here, however, the current mirror at MDK introduces a certain error to the automatic power control (c.f. Electrical Characteristics Nos. 108, 110).

Even **N-type** laser diodes can be operated by iC-WKM; **iC-WKN**, however, which has been optimised for use with these diodes, may be a better choice.

#### Layout

To prevent instability of the regulator an **additional** capacitor (ca. 100 pF) must be positioned directly at the iC's pin CI. Depending on the laser diode, capacitor CM with typ. 2 nF in parallel to RM may be required for stability.

Pin AGND acts solely as a ground reference for the power regulator (CI and RM) and should not be short-circuited with GND externally. This could have a negative effect on the control behavior and monitor functions.

#### Cooling

Laser diodes should be sufficiently cooled, particularly with the power-regulated operation of setups which use iC-WKM, for example. The power dissipation in the laser diode otherwise causes the diode to heat up and the level of efficiency to drop which the power control unit then compensates for by increasing the laser current. This in turn brings about a rise in power dissipation in the laser diode and thus also in temperature. In this instance the laser diode could be damaged (resulting in spottiness and an increase in operating current) or even destroyed before the overcurrent shutdown threshold in iC-WKM is reached. This applies in particular to blue laser diodes whose power dissipation is considerably

higher than that of red laser diodes, for example, due to the higher forward voltage.

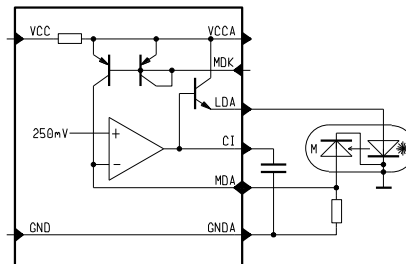

Figure 3: Operation of an **M-type** laser diode

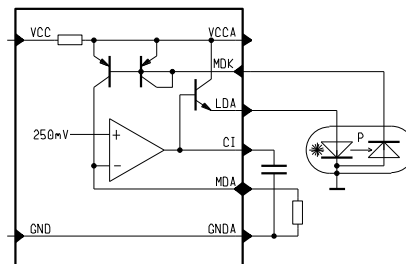

Figure 4: Operation of a **P-type** laser diode

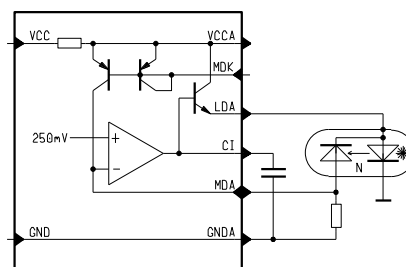

Figure 5: Operation of an **N-type** laser diode

# iC-WKM

## M-TYPE CW LASER DIODE DRIVER

Rev C2, Page 11/12

### REVISION HISTORY

| Rel. | Rel. Date* | Chapter               | Modification                                 | Page |
|------|------------|-----------------------|--|------|
| C2   | 2015-11-27 | PACKAGES              | New package drawings                         | 1    |
|      |            | PACKAGING INFORMATION | New package drawings                         | 3-5  |
|      |            | ORDERING INFORMATION  | Order designation changed from SO8 to SO8-TP | 12   |

iC-Haus expressly reserves the right to change its products and/or specifications. An info letter gives details as to any amendments and additions made to the relevant current specifications on our internet website [www.ichaus.com/infoletter](http://www.ichaus.com/infoletter); this letter is generated automatically and shall be sent to registered users by email.

Copying – even as an excerpt – is only permitted with iC-Haus' approval in writing and precise reference to source.

iC-Haus does not warrant the accuracy, completeness or timeliness of the specification and does not assume liability for any errors or omissions in these materials.

The data specified is intended solely for the purpose of product description. No representations or warranties, either express or implied, of merchantability, fitness for a particular purpose or of any other nature are made hereunder with respect to information/specification or the products to which information refers and no guarantee with respect to compliance to the intended use is given. In particular, this also applies to the stated possible applications or areas of applications of the product.

iC-Haus products are not designed for and must not be used in connection with any applications where the failure of such products would reasonably be expected to result in significant personal injury or death (*Safety-Critical Applications*) without iC-Haus' specific written consent. Safety-Critical Applications include, without limitation, life support devices and systems. iC-Haus products are not designed nor intended for use in military or aerospace applications or environments or in automotive applications unless specifically designated for such use by iC-Haus.

iC-Haus conveys no patent, copyright, mask work right or other trade mark right to this product. iC-Haus assumes no liability for any patent and/or other trade mark rights of a third party resulting from processing or handling of the product and/or any other use of the product.

\* Release Date format: YYYY-MM-DD

## **iC-WKM**

### M-TYPE CW LASER DIODE DRIVER

Rev C2, Page 12/12

#### **ORDERING INFORMATION**

| Type   | Package              | Order Designation |
|--------|----------------------|-------------------|
| iC-WKM | SO8 with thermal pad | iC-WKM SO8-TP     |
| iC-WKM | DFN10 4 mm x 4 mm    | iC-WKM DFN10      |
|        | Evaluation Board     | iC-WKM EVAL WKM1D |

Please send your purchase orders to our order handling team.

For technical support, information about prices and terms of delivery please contact us.