

# HASO FIRST

## Wavefront sensor The Chameleon

On demand wavelength  
High accuracy  
Best cost performance ratio



 compatible



Imagine  
Optic

HASO FIRST DATASHEET 2411

# HASO FIRST +

**The HASO Shack-Hartmann Wavefront Sensor optimized for one wavelength, the one you really need.**

The HASO FIRST is now faster and has an improved spatial resolution while keeping the same accuracy and optimized price point.



Compatible with the **Optical Engineer Companion** modular system: easily combine the accessories you need.

## APPLICATIONS

Successfully used in the most demanding applications in optical metrology, microscopy, and laser diagnostics, the HASO FIRST performs multiple functions :

- + Quantify the aberrations of an optical system
- + Align optical systems to ensure that it works optimally
- + Predict the performance of optical systems in terms of focusing capability or imaging quality
- + Quantify the effects of temperature and gravity on system performance
- + Verify that the optics comply with specifications
- + Drive a wavefront corrector to correct for system aberrations
- + Check whether the optical mount overly distorts the optics

## FEATURES

- + Beam collimation with an accuracy better than 200 m radius of curvature
- + A 20 mm focal length measurement with a sensitivity of 1  $\mu\text{m}$  RMS
- + Direct wavefront acquisition of converging and diverging F/5 beams with an accuracy of  $\lambda/100$  RMS including astigmatism and high-order aberrations
- + Control and adjustment of axial laser beam deviation better than 5  $\mu\text{rad}$  RMS
- +  $\pm 50$  nm calibration bandwidth or extended wavelength range optional:  $\pm 150\text{nm}$  around the calibration wavelength



HASO FIRST DATASHEET 2411

## SPECIFICATIONS\*

### OPERATING SPECS

Aperture dimension	4.5 x 3.7 mm <sup>2</sup>
Number of microlenses	44 x 36
Maximum acquisition frequency	125 Hz (USB 3.0) or 30 Hz (with GigE converter)
One wavelength $\pm$ 50 nm in the range	350 - 1100 nm
Minimum power	0.15 nW
External trigger TTL signal	TTL signal
Operating system	Windows 10 & 11

### OPTICAL SPECS

Repeatability	$< \lambda/200$ RMS
Absolute wavefront measurement accuracy	$\sim \lambda/100$ RMS
Spatial sampling	$\sim 100 \mu\text{m}$
Local radius of curvature dynamic range	$\pm 0.008 \text{ m to } \pm \infty$

### MISC

Dimensions (Height x Width x Length)	42 x 47 x 60 mm <sup>3</sup> (USB 3.0)
Weight for USB version	200 g
Working temperature	15 - 30 °C
Interface	USB 3.0 or optional GigE converter
Power consumption	3.1 W

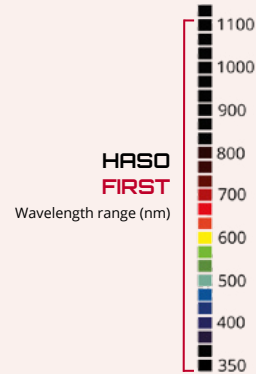

### HASO FIRST

Dynamic range at  $\lambda = 635 \text{ nm}$

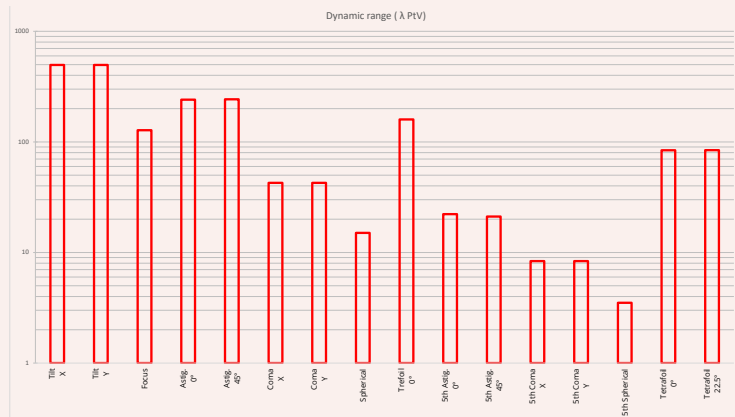

\*Subject to changes without further notice

## DIMENSIONS\*\* (mm)

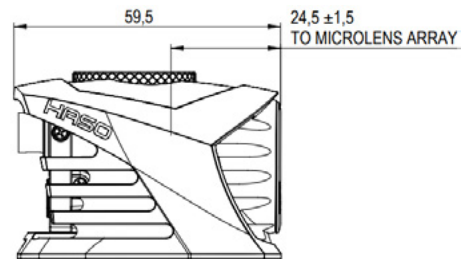
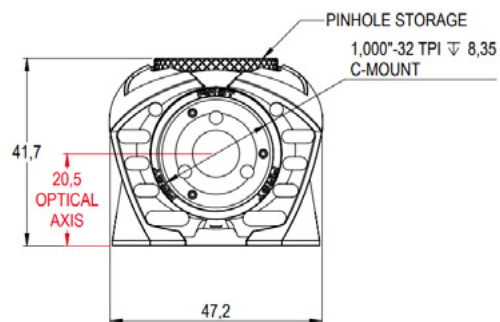

\*\* USB 3.0 model

HASO FIRST DATASHEET 2411

## SOFTWARE

### WAVEVIEW™ Metrology Software

WAVEVIEW™ is the most advanced wavefront measurement and analysis software.

It offers more than 150 features and tools optimized for a wide range of highly demanding applications.

#### Options :

- + Extensions for PSF, MTF, M<sup>2</sup> and Strehl ratio
- + Optional SDK in C/C++, LabVIEW and Python

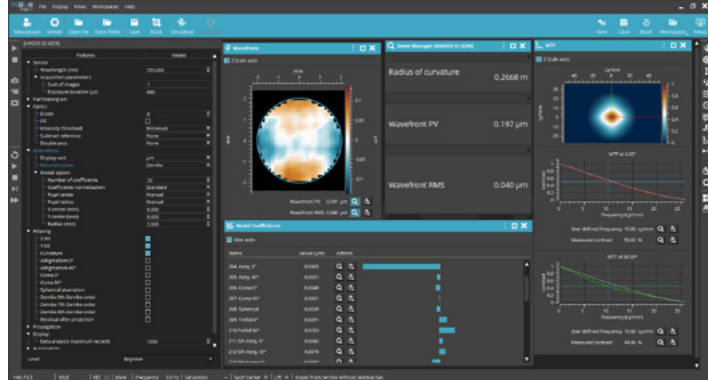

### WAVETUNE™ Adaptive Optics Software

WAVETUNE™ is a unique software that seamlessly combines wavefront measurement and correction features with extensive instrument diagnostics.

It is perfectly adapted to our HASO wavefront sensors, ILAO STAR, MIRAO and mu-DM deformable mirrors, as well as to a wide range of active components.

#### Options :

- + Optional SDK in C/C++, LabVIEW and Python

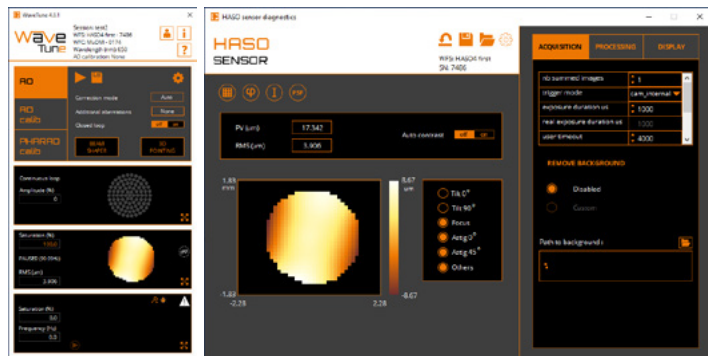

HASO FIRST DATASHEET 2411