

Temperature Sensor Module Product Information



Dexter Research is proud to announce a low-cost, calibrated, non-contact, infrared, Temperature Sensor Module (TSM). Dexter's TSM is based on our leadership in thermopile technology. Programmable outputs, flexible power requirements and multiple sensors support turnkey solutions. Applications include health care; environmental monitoring; HVAC control; temperature measurement and control of home appliances, printers, copiers, manufacturing equipment, and more.

1. Features

- Dexter Research's superior thermopile technology.
- Dexter calibrated IR thermometer with linear digital output.
- Easy to integrate small TO-5/TO-39 package.
- Low-cost, competitive pricing.
- Standard calibration in wide temperature ranges: -40 to 85°C for ambient temperature. -70 to 380°C for object temperature.
- Better than 0.5°C repeatability over the ranges $T_a=0-50^\circ\text{C}$ and $T_o=0-60^\circ\text{C}$
- 0.02°C readout resolution possible.
- Fast refresh rate of up to 244 samples/second.
- Simple emissivity correction by user.
- Continuous temperature readout through PWM (Pulse Width Modulation) output.
- 2-wire SMBus compatible interface for reading temperatures and reconfiguring the sensor.
- Capable of sensor networks of up to 100 modules.
- High reliability and long-term stability.
- Excellent ESD/EMC characteristics.
- Available for 3V and 5V applications. Easy to adapt for voltage sources from 6-24V.
- Power saving mode for battery operation.
- Traceability through unique ID number in non-volatile memory.
- RoHS compliant.

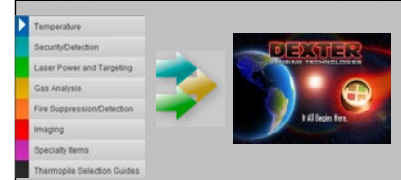

P/N	TSM Configurations					
	Supply	5 volt	3 volt	70° FOV	35° FOV	Medical Grade Gradient Compensated
MD-0003	X		X			
MD-0005	X			X		X
MD-0006		X	X			
MD-0007		X		X		X
MD-0008		X	X		X	

Superior TSM performance is driven by Dexter Research thermopile technology.

IT ALL BEGINS HERE.
Dexter Research is ISO 9001:2008 Certified

8674 Rev E

Update: 5/2/13

Temperature Sensor Module

2. Overview of Dexter's unique TSM

Dexter's TSM is a ready-to use, cost-effective, non-contact IR thermometer. Calibrated output provides accurate object temperature sensing. You can customize this unit to accommodate a wide range of temperatures, power supplies, refresh rates and object emissivity. High memory reliability is assured by our TSM's embedded error checking and correction mechanism. Our TSM is housed in a industry standard TO-5/TO-39 package.

Dexter's TSM is ideally suited for handheld portable applications thanks to its low power consumption and sleep mode. Our digital sensor interface offers you a choice of a power-up-and-measure PWM or an enhanced access SMBus compatible protocol. Just two signal lines can accommodate systems with up to 100 modules. A wide variety of freezing/boiling prevention and alert systems are made possible thanks to a built-in thermal relay function.

Applications are found across many disciplines that include:

- Healthcare
- Human and animal body temperature measurement
- Thermal comfort sensor for built-in and portable HVAC control
- Temperature measurement and control of manufacturing equipment
- Temperature measurement and control of home appliances, printers and copiers
- Thermal relay, alarms and notifications – can be integrated with email and text notifications

3. TSM Evaluation Board

The evaluation kit (part number MD-0004 includes TSM MD-0003) is designed to support infrared temperature sensor modules. The communication between your PC and the evaluation board is accomplished via USB.

The main purpose of the evaluation kit is to allow customers to test the TSM for virtually any application. Customers can quickly evaluate the TSM for temperature range, optics, etc. to find the best configuration to meet their application without the need of additional hardware.

The Evaluation Board is based on the Microchip PIC18F4550, which supports cost competitive hardware, low-cost development tools and software that are an excellent starting point for any design. Dexter offers design services, software, and customization of the evaluation board to meet your needs as well.



Temperature Sensor Module

3. Table of Contents

1	Features.....	1
2	Overview of Dexter's Unique TSM.....	2
	2.1 Evaluation Kit.....	2
3	Table of Contents.....	3
4	Temperature Accuracy of the TSM.....	4
5	Field of View (FOV).....	6
6	Maximum Ratings.....	7
7	Pin Description.....	7
8	Theory of Operations.....	8
	8.1 Amplifier.....	9
	8.2 Voltage Supply and POR.....	9
	8.3 EEPROM.....	9
	8.4 PWMCTRL.....	10
	8.5 ConfigRegister1.....	11
	8.6 On-chip Filtering and Settling Time.....	12
	8.7 RAM.....	13
9	Electrical Specifications.....	14
	9.1 MD-0003 and MD-0005.....	14
	9.2 MD-0006, MD-0007 and MD-0008.....	16
10	Computation of Ambient and Object Temperatures.....	18
	10.1 Ambient Temperature T_a	18
	10.2 Object Temperature T_o	18
	10.3 Calculation Process.....	19
11	Thermal Relay Configuration.....	20
12	SMBus Compatible 2-wire Protocol.....	21
	12.1 Differences with the Standard SMBus Specification.....	22
	12.2 Detailed Description.....	22
	12.2.1 Bus Protocol.....	22
	12.2.2 SMBus Read Word.....	23
	12.2.3 SMBus Write Word.....	24
	12.3 Bus Timing.....	24
	12.4 SCL Zener Diode.....	26
	12.5 Commands.....	27
	12.6 Sleep Mode.....	27
13	Pulse Width Modulation (PWM).....	28
	13.1 Single PWM Format.....	29
	13.2 Extended PWM Format.....	30
	13.3 Altering the PWM Output Temperature Range.....	31
	13.4 Switching Between PWM and SMBus Communication.....	32
	13.4.1 PWM is enabled.....	32
	13.4.2 Request condition.....	32
	13.4.3 PWM is disabled.....	32
14	Standard Information Regarding Manufacturability of TSM with Soldering Processes.....	33
15	Applications Information.....	34
16	ESD Precautions.....	38
17	Package Information.....	39
18	References.....	39
19	Disclaimer.....	40
20	Abbreviations.....	40
21	Revisions Table.....	41

Temperature Sensor Module

4. Temperature Accuracy

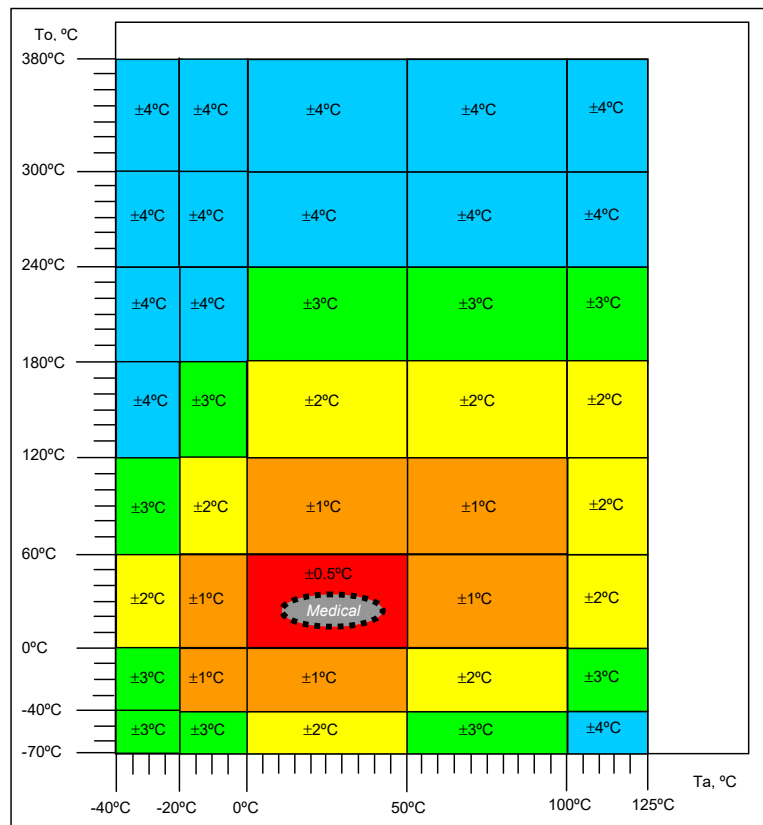

Figure 1. Accuracy of TSM (Ta, To). See Figure 2 for Medical Grade accuracy.

All accuracy specifications apply to settled isothermal conditions. The accuracy data are only valid if the object fills the FOV of the sensor completely.

If a voltage regulator is not used for Vdd supplies, then Ta and To will be less accurate than the factory calibration. Additional compensation equation of 0.6°C/Vdd should be used in this case. [Example: Modules are factory calibrated when Vdd = 3.0V, or 5.0V depending on the module. If Vdd = 2.4V, then Ta and To will read -0.36°C degrees lower, and when Vdd = 3.6 then Ta and To will read 0.36°C higher.] This reading can be corrected by either using a voltage regulator to supply Vdd, or by applying the compensation factor (0.6 °C/V). To compensate for Vdd ≠ 3.0V or 5.0V, use the following equation: To compensation = To - [(Vdd - 3) * 0.6].

Temperature Sensor Module

Dexter offers a version of its TSM with accuracy suited for medical applications, the MD-0008. The accuracy in the range T_a 10°C to 40°C and T_o 32°C to 42°C is shown in diagram below. The accuracy for the rest of the temperature ranges is the same as in previous diagram. All accuracy specifications apply under settled isothermal conditions.

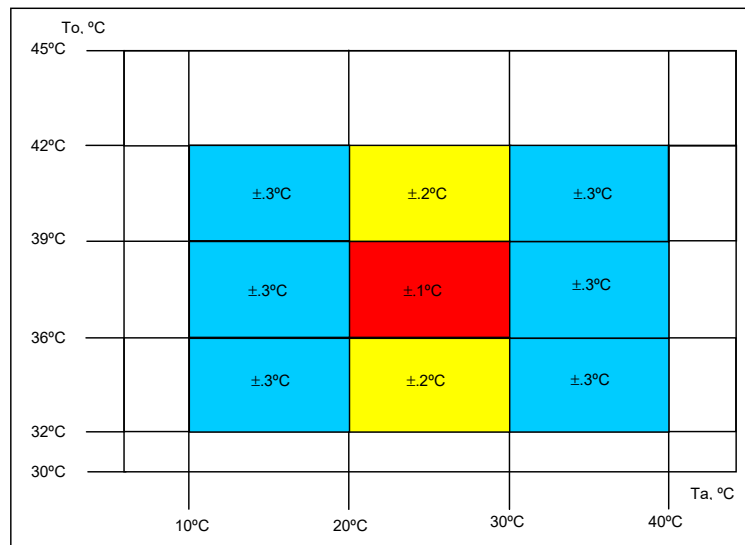

Figure 2. Accuracy of TSM (T_a , T_o) for medical applications.

Contact Dexter Research Inc. for further information regarding medical accuracy specification and versions.

The accuracy of the thermometer can be influenced by temperature differences in the package induced by a variety of causes such as: hot electronics behind the sensor, heaters/coolers behind or beside the sensor or when the measured object is so close to the sensor that it not only radiates on the sensing element in the thermometer but also heats the thermometer casing.

Avoid introducing strong heat sources close to the sensor or to shield the sensor from them, especially relevant for thermometers with a small Field Of View (FOV) like the MD-0005 and MD-0007 as the energy received by the sensor from the object is reduced.

Temperature Sensor Module

5. Field Of View (FOV)

Field of view is determined at 50% of thermopile signal and with respect to the sensor main axis.

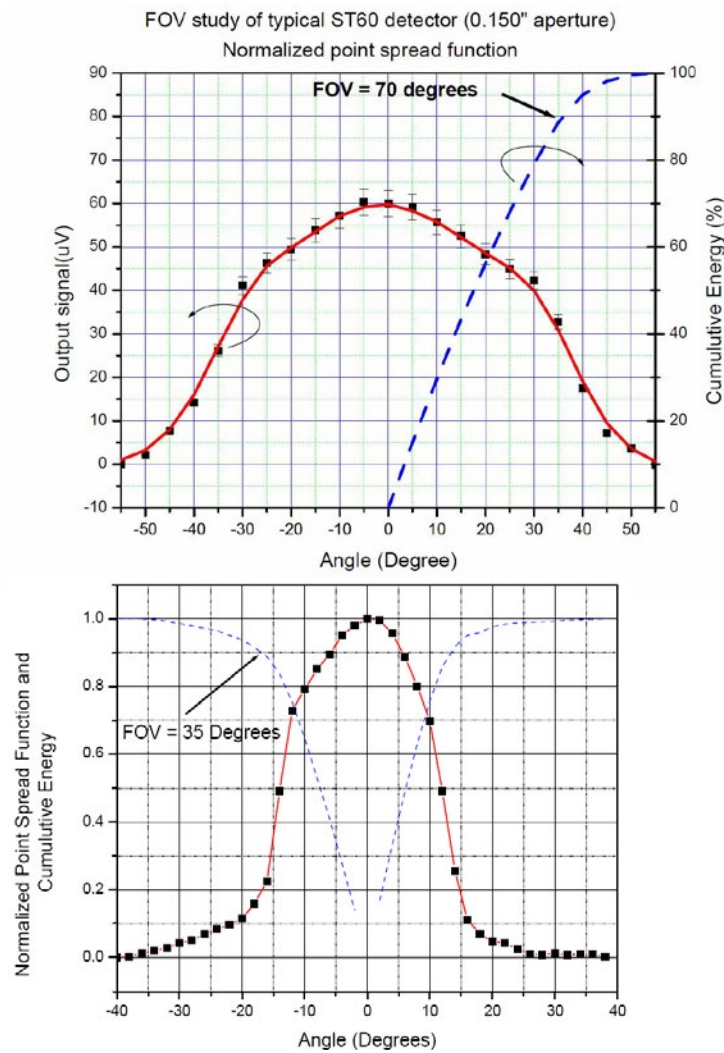

Figure 3. FOV for 70 and 35 degrees.

Temperature Sensor Module

6. Maximum Ratings

Parameter	MD-0003, MD-0005 All 5 Volt devices	MD-0006, MD-0007 MD-0008 All 3 Volt devices
Supply Voltage, V_{DD} (over voltage)	7 V	5 V
Supply Voltage, V_{DD} (operating)	5.5 V	3.6 V
Reverse Voltage	0.4 V	
Operating Temperature Range, T_A	-40...+85°C	
Storage Temperature Range, T_S	-40...+125°C	
ESD Sensitivity (AEC Q100 002)	2 kV	
DC Current into SCL / Vz (Vz mode)	2 mA	
DC Sink Current, SDA / PWM pin	25 mA	
DC Source Current, SDA / PWM pin	25 mA	
DC Clamp Current, SDA / PWM pin	25 mA	
DC Clamp Current, SCL pin	25 mA	

Exceeding the absolute maximum ratings may affect device reliability and / or cause permanent damage.

7. Pin Description

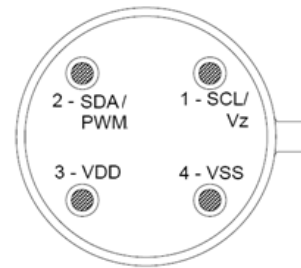

Figure 4. Package Top View

Pin Name	Pin Description
1. SCL / Vz	Serial Clock (SCL) input for 2-wire communications protocol. For an external 8 -16V source to a MD-0003 or MD-0005, a 5.7V zener (Vz) is integrated at this pin for connection of external bipolar transistor. See Figure 24 High voltage source operation for examples.
2. SDA / PWM	Serial Data (SDA) digital input / output. In SMBus compatible mode automatically configured as open drain NMOS. Optional mode: the measured object temperature is available at this pin Pulse Width Modulated (PWM).
3. VDD	External Voltage Supply. V_{DD}
4. VSS	Ground. V_{SS} The metal can is electrically connected to this pin.

Temperature Sensor Module

8. Theory of Operations

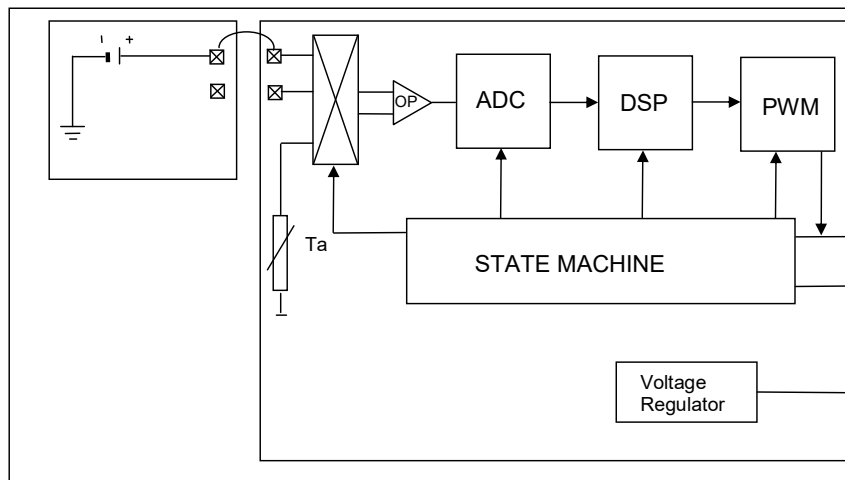

Figure 5. TSM Architecture.

The operation of the TSM is controlled by an internal state machine, which controls the measurements and calculations of the object and ambient temperatures. Calibrated temperature measurements are then available through the PWM output or the SMBus compatible interface.

The processor supports 2 IR sensors (second one not implemented in the single zone units). The output of the IR sensors is amplified by a low noise low offset chopper amplifier with programmable gain, converted by a Sigma Delta analog to digital modulator to a single bit stream and fed to a powerful DSP for further processing. The signal is conditioned by programmable (by means of EEPROM) FIR and IIR low pass filters for noise reduction of the input signal to achieve the desired performance and refresh rate. The output of the IIR filter is the measurement result and is available in the internal RAM. 3 different cells are available: one for the on-board temperature sensor (on chip PTAT or PTC) and 2 for the IR sensors.

Based on results of the above measurements, the corresponding ambient temperature T_a and object temperatures T_o are calculated. Both calculated temperatures have an internal resolution of $0.01\text{ }^\circ\text{C}$ ($-273.15\text{ }^\circ\text{C}$ to $328.19\text{ }^\circ\text{C}$) / 16 bit). The data for T_a and T_o can be read in two ways, reading RAM cells dedicated for this purpose via the 2-wire interface ($0.02\text{ }^\circ\text{C}$ resolution, 15 bit fixed range), or through the PWM digital output (10 bit resolution, configurable range).

In the last step of the measurement cycle, the measured T_a and T_o are rescaled to the desired output resolution of the PWM) and the recalculated data is loaded in the registers of the PWM state machine, which creates a constant frequency with a duty cycle representing the measured data.

Temperature Sensor Module

8.1 Amplifier

A low noise, low offset amplifier with programmable gain is implemented for amplification of the IR sensor voltage. With a carefully designed input modulator and balanced input impedance, an offset as low as 0.5 μV is achieved.

8.2 Voltage Supply and POR

The module can operate from 2 different voltage supplies:

VDD = +5.0 V => MD-0003 and MD-0005

VDD = +3.0 V => MD-0006, MD-0007 and MD-0008 (battery or regulated supply)

Refer to "Applications information" section for information about adopting higher voltage supplies from 6 Volts to 24 Volts.

The Power On Reset (POR) is connected to Vdd supply. The on-chip POR circuit provides an active (high) level of the POR signal when the Vdd voltage rises above approximately 0.5 V and holds the entire TSM in reset until the Vdd is higher than the specified POR threshold V_{POR} . (note that this level is different for 5 Volt and 3 Volt versions).

During the time POR is active, the POR signal is available as an open drain (active high) at the PWM / SDA pin. After the TSM exits the POR condition, the function programmed in EEPROM takes precedence for that pin.

8.3 EEPROM

A limited number of addresses in the EEPROM memory can be changed by the customer. Erase (write 0) must take place before write of the desired data can be made. The whole EEPROM can be read via SMBus interface.

EEPROM (32 x 16)		
Name	Opcode and Address	Write access
To _{max}	0x20h	Yes
To _{min}	0x21h	Yes
PWMCTRL	0x22h	Yes
Ta range	0x23h	Yes
Emissivity correction coefficient (Ke)	0x24h	Yes
Config Register1	0x25h	Yes
Factory reserved	0x26h	No
...
Factory reserved	0x2Dh	No
SMBus address	0x2Eh	Yes
Factory reserved	0x2Fh	Yes
Factory reserved	0x30h	No
...
Factory reserved	0x38h	No
Factory reserved	0x39h	Yes
Factory reserved	0x3Ah	No
Factory reserved	0x3Bh	No
ID number	0x3Ch	No
ID number	0x3Dh	No
ID number	0x3Eh	No
ID number	0x3Fh	No

The addresses To_{max}, To_{min} and Ta range are for customer dependent object and ambient temperature ranges.

Temperature Sensor Module

For details see section 8.3 “Altering the PWM Output Temperature Range” in this document

The address **Emissivity** contains the object emissivity (factory default 1.0 = 0xFFFF), 16 bit.

$$\text{Emissivity} = \text{dec2hex} [\text{round} (65535 \times \epsilon)]$$

Where dec2hex [round (X)] represents decimal to hexadecimal conversion with round off to nearest value (not truncation). In this case the physical emissivity values are $\epsilon = 0.1 \dots 1.0$.

8.4 PWMCTRL

PWM period configuration: period in extended PWM mode is twice the period in single PWM mode. In single PWM mode period is $T = 1.024 \times P$ [ms], where P is the number, written in bits 15..9 PWMCTRL. Maximum period is then 131.072 ms for single and 262.144 ms for extended mode. These values are typical and depend on the on-chip RC oscillator absolute value. The duty cycle must be calculated instead of working with the high time only in order to avoid errors from the period absolute value deviations.

The **PWMCTRL** (address 0x22h) consists of control bits for configuring the PWM / SDA pin as follows:

15	14	13	12	11	10	9	8	7	6	5	4	3	2	1	0	PWM Control bit map	
																0 = PWM Mode extended 1 = PWM Mode single	
																0 = PWM Mode disabled 1 = PWM Mode enabled	
																0 = SDA pin - Open Drain 1 = SDA pin - push-pull	
																0 = PWM selected 1 = Thermal relay selected	
																= PWM repetition number 0 to 62 step 2	
																= PWM period 1.024* ms (Single PWM) or 2.048* ms (Extended PWM) multiplied by the number written in this place. (128 for case when number is 0)	

* Values are for nominal HFO frequency

Temperature Sensor Module

8.5 ConfigRegister1

The **ConfigRegister1** (address 0x25h) consists of control bits for configuring the analog and digital parts.

15	14	13	12	11	10	9	8	7	6	5	4	3	2	1	0	Config Register 1 bit map
																0 0 0 - IIR (5) a1=0.5, b1=0.5
																0 0 1 - IIR (6) a1=0.25, b1=0.75
																0 1 0 - IIR (7) a1=0.166(6), b1=0.83(3)
																0 1 1 - IIR (8) a1=0.125, b1=0.875
																1 0 0 - IIR (1) a1=1.0, b1=0 IIR bypass
																1 0 1 - IIR (2) a1=0.8, b1=0.2
																1 1 0 - IIR (3) a1=0.666, b1=0.333
																1 1 1 - IIR (4) a1=0.571, b1=0.428
																0 - repeat sensor test "OFF" Do not alter
																1 - repeat sensor test "ON" Do not alter
																0 0 - Ta, Tobj1
																0 1 - Ta, Tobj2
																1 0 - Tobj2
																1 1 - Tobj1, Tobj2
																0 - Single IR sensor
																1 - Dexter reserved DO NOT alter
																- Positive sign of
																0 Ks Dexter reserved DO NOT alter
																1 - Negative sign of Ks
																0 0 0 - FIR = 8 not recommended
																0 0 1 - FIR = 16 not recommended
																0 1 0 - FIR = 32 not recommended
																0 1 1 - FIR = 64 not recommended
																1 0 0 - FIR = 128
																1 0 1 - FIR = 256
																1 1 0 - FIR = 512
																- FIR =
																1 1 1 1024
																0 0 0 - GAIN = 1 Amp Bypassed
																0 0 1 - GAIN = 3 Dexter reserved DO NOT alter
																0 1 0 - GAIN = 6
																0 1 1 - GAIN = 12.5
																1 0 0 - GAIN = 25
																1 0 1 - GAIN = 50
																1 1 0 - GAIN = 100
																1 1 1 - GAIN = 100
																0 - Positive sign of Kt2
																1 - Negative sign of Kt2 Dexter reserved DO NOT alter
																0 -Enable sensor test
																1 -Disable sensor test Dexter reserved DO NOT alter

Temperature Sensor Module

WARNING:

The following bits / registers:

Ke[15..0]; Config Register1 [13..11;7;3] ; addresses 0x2Fh and 0x39h.

Should not be altered in order to keep the factory calibration relevant, except with special tools!

Contact Dexter for tools availability.

8.6 On-chip Filtering and Settling Time

The TSM features configurable on-chip digital filters. They allow customization for speed or noise.

The evaluation board, MD-0004 supported by PC SW allows easy configuration of the filters, while not requiring in-depth understanding of the EEPROM.

The available filter settings and the settling times they give are listed below. Settling time depends on two configurations: IIR filter settings and FIR filter settings. The FIR filter has a straightforward effect on noise (a 4 times decrease of settling time increases the noise 2 times and vice versa). The IIR filter provides an additional, spike limiting, feature. Spike limit is also listed and defines to what level the magnitude of a spike would be limited – for example, 25% denotes that if a 20°C temperature delta spike is measured the temperature reading by the TSM will spike only 5°C. More details are available in the application notes from Dexter.

IIR setting	FIR setting	Single zone Settling time (s)	Bandwidth Hz (≈)	Spike limit
xxx	000..011			Not recommended
100	100 = 128	0.04	244.1	100.0%
100	101 = 256	0.05	122.1	100.0%
100	110 = 512	0.06	61.0	100.0%
100	111 = 1024	0.10	30.5	100.0%
101	100 = 128	0.12	86.2	80.0%
101	101 = 256	0.16	43.0	80.0%
101	110 = 512	0.22	21.5	80.0%
101	111 = 1024	0.35	10.8	80.0%
110	100 = 128	0.24	47.4	66.7%
110	101 = 256	0.30	23.8	66.7%
110	110 = 512	0.43	11.9	66.7%
110	111 = 1024	0.70	6.0	66.7%
111	100 = 128	0.26	35.0	57.0%
111	101 = 256	0.34	17.5	57.0%
111	110 = 512	0.48	8.8	57.0%
111	111 = 1024	0.78	4.4	57.0%
000	100 = 128	0.30	28	50.0%

Temperature Sensor Module

000	101 = 256	0.37	14	50.0%
000	110 = 512	0.54	7.0	50.0%
000	111 = 1024	0.86	3.5	50.0%
001	100 = 128	0.70	11.2	25.0%
001	101 = 256	0.88	5.6	25.0%
001	110 = 512	1.30	2.8	25.0%
001	111 = 1024	2.00	1.4	25.0%
010	100 = 128	1.10	7.1	16.7%
010	101 = 256	1.40	3.5	16.7%
010	110 = 512	2.00	1.8	16.7%
010	111 = 1024	3.30	0.9	16.7%
011	100 = 128	1.50	5.2	12.5%
011	101 = 256	1.90	2.6	12.5%
011	110 = 512	2.80	1.3	12.5%
011	111 = 1024	4.50	0.7	12.5%

Note: Settling time is in seconds which depends on internal oscillator absolute value. 100% spike limit appears with the IIR filter bypassed, and there is no spike limitation.

8.7 RAM

It is not possible to write into the RAM memory. It can only be read and only a limited number of RAM registers are of interest to the customer.

RAM (32 x 16)		
Name	Opcode and Address	Read access
Factory reserved	0x00h	Yes
...
Ambient sensor data	0x03h	Yes
IR 1 sensor data	0x04h	Yes
IR 2 sensor data	0x05h	Yes
Ta calibrated data	0x06h	Yes
Tobj1 calibrated data	0x07h	Yes
Tobj2 calibrated data	0x08h	Yes
Factory reserved	0x09h	Yes
...
Factory reserved	0x1Fh	Yes

Temperature Sensor Module

9. Electrical Specifications

9.1 MD-0003 and MD-0005

All parameters are preliminary for $T_A = 25\text{ }^\circ\text{C}$, $V_{DD} = 5\text{ V}$ (unless otherwise specified)

Parameter	Symbol	Test Conditions	Min	Typ	Max	Units
Supplies						
External Supply	V_{DD}		4.5	5	5.5	V
Supply Current	I_{DD}	No load		1	2	mA
Supply Current (programming)	I_{DDpr}	No load, erase/write EEPROM operations		1.5	2.5	mA
Zener Voltage	V_Z	$I_Z = 75 \dots 1000\text{ }\mu\text{A}$ ($T_A = \text{room}$)	5.5	5.7	5.9	V
Zener Voltage	$V_Z(T_A)$	$I_Z = 70\text{ }\mu\text{A} \dots 1000\text{ }\mu\text{A}$, full temperature range	5.15	5.75	6.24	V
Power On Reset						
POR Level	V_{POR-up}	Power-up (full temperature range)	1.4	1.75	1.95	V
POR Level	$V_{POR-down}$	Power-down (full temperature range)	1.3	1.7	1.9	V
POR Hysteresis	$V_{POR-hys}$	Full temperature range	0.08	0.1	1.15	V
V_{DD} Rise Time (10 - 90% V_{DD})	T_{POR}	Ensure POR signal			20	ms
Output Valid (result in RAM)	T_{valid}	After POR			0.15	s
Pulse width modulation¹						
PWM Resolution	PWMres	Data band		10		bit
PWM Output Period	$PWM_{T, def}$	Factory default, internal oscillator factory calibrated		1.024		ms
PWM Period Stability	$dPWM_T$	Internal oscillator factory calibrated, over the entire operation range and supply voltage	-4		+4	%
Output High Level	PWM_{HI}	$I_{source} = 2\text{ mA}$	$V_{DD} - 0.2$			V
Output Low Level	PWM_{LO}	$I_{sink} = 2\text{ mA}$			$V_{SS} + 0.2$	V
Output Drive Current	I_{drive_PWM}	$V_{out, H} = V_{DD} - 0.8\text{ V}$		7		mA
Output Sink Current	I_{sink_PWM}	$V_{out, L} = 0.8\text{ V}$		13.5	1	mA

Temperature Sensor Module

Parameter	Symbol	Test Conditions	Min	Typ	Max	Units
SMBus compatible 2-wire interface²						
Input High Voltage	$V_{IH}(Ta, V)$	Over temperature and supply	$V_{DD} - 0.1$			V
Input Low Voltage	$V_{IL}(Ta, V)$	Over temperature and supply			0.6	V
Output Low Voltage	V_{OL}	SDA pin in open drain mode, over temperature and supply, $I_{sink} = 2\text{ mA}$			0.2	V
SCL Leakage	$I_{SCL} \text{ leak}$	$V_{SCL} = 4\text{ V}, Ta = +85^\circ\text{C}$			30	μA
SDA Leakage	$I_{SDA} \text{ leak}$	$V_{SDA} = 4\text{ V}, Ta = +85^\circ\text{C}$			0.3	μA
SCL Capacitance	C_{SCL}				10	pF
SDA Capacitance	C_{SDA}				10	pF
Slave Address	SA	Factory default		5A		hex
Wake up Request	t_{wake}	SDA low	33			ms
SMBus Request	t_{REQ}	SCL low	1.44			ms
Timeout, Low	$T_{imeout, L}$	SCL low	27		33	ms
Timeout, High	$T_{imeout, H}$	SCL high	45		55	μs
Acknowledge Setup Time	Tsuac(MD)	8-th SCL falling edge, Master	0.5		1.5	μs
Acknowledge Hold Time	Thdac(MD)	9-th SCL falling edge, Master	1.5		2.5	μs
Acknowledge Setup Time	Tsuac(SD)	8-th SCL falling edge, Slave	2.5			μs
Acknowledge Hold Time	Thdac(SD)	9-th SCL falling edge, Slave	1.5			μs
EEPROM						
Data Retention		$Ta = +85^\circ\text{C}$	10			years
Erase / Write Cycles		$Ta = +25^\circ\text{C}$	100,000			times
Erase / Write Cycles		$Ta = +85^\circ\text{C}$	10,000			times
Erase Cell Time	T_{erase}			5		ms
Write Cell Time	T_{write}			5		ms

Notes: SMBus and refresh rate timings are given for the nominal calibrate HFO frequency and will vary with this frequency.

- All PWM timing specifications are given for single PWM output. For the extended PWM output each period has twice the timing specifications. With large capacitive loads lower PWM frequency is recommended. If configured for Thermal relay, output has the PWM DC specifications and can be programmed as push-pull, or NMOS open drain. PWM is free-running; power-up factory default is SMBus.
- For SMBus compatible interface on 12V refer to the Application information. SMBus compatible interface is described in detail in the SMBus description section. Maximum number of devices on one bus is 100, higher pull-up currents are recommended for higher number of devices, faster bus data transfer rates, and increased reactive loading of the bus.

All voltages are referenced to VSS (ground) unless otherwise noted.

Power savings mode is not available on the 5 Volt versions. (MD-0003, MD-0005)

Temperature Sensor Module

9.2 MD-0006, MD-0007, MD-0008

All parameters are preliminary for $T_A = 25\text{ }^\circ\text{C}$, $V_{DD} = 3\text{ V}$ (unless otherwise specified)

Parameter	Symbol	Test Conditions	Min	Typ	Max	Units
Supplies						
External Supply	V_{DD}		2.6	3	3.6	V
Supply Current	I_{DD}	No load		1	2	mA
Supply Current (programming)	I_{DDpr}	No load, erase/write EEPROM operations		1.5	2.5	mA
Power-Down Supply Current	I_{sleep}	no load	1	2.5	5	μA
Power-Down Supply Current	I_{sleep}	Full temperature range	1	2.5	6	μA
Power On Reset						
POR Level	V_{POR}	Power-up, power-down and brown-out	1.4	1.75	1.95	V
POR Level	$V_{POR-down}$	Power-down (Full temperature range)	1.3	1.7	1.9	V
POR Hysteresis	$V_{POR-hys}$	Full temperature range	0.08	0.1	1.15	V
V_{DD} Rise Time (10 - 90% V_{DD})	T_{POR}	Ensure POR signal			20	ms
Output Valid	T_{valid}	After POR			0.15	s
Pulse width modulation¹						
PWM Resolution	PWM_{res}	Data band		10		bit
PWM Output Period	$PWM_{T, def}$	Factory default, internal oscillator factory calibrated		1.024		ms
PWM Period Stability	$dPWM_T$	Internal oscillator factory calibrated, over the entire operation range and supply voltage	-4		+4	%
Output High Level	PWM_{HI}	$I_{source} = 2\text{ mA}$	$V_{DD} - 0.25$			V
Output Low Level	PWM_{LO}	$I_{sink} = 2\text{ mA}$			$V_{SS} + 0.25$	V
Output Drive Current	I_{drive_PWM}	$V_{out, H} = V_{DD} - 0.8\text{V}$		4.5		mA
Output Sink Current	I_{sink_PWM}	$V_{out, L} = 0.8\text{V}$		11		mA

Temperature Sensor Module

Parameter	Symbol	Test Conditions	Min	Typ	Max	Units
SMBus compatible 2-wire interface²						
Input High Voltage	$V_{IH}(Ta, V)$	Over temperature and supply	$V_{DD} - 0.1$			V
Input Low Voltage	$V_{IL}(Ta, V)$	Over temperature and supply			0.6	V
Output Low Voltage	V_{OL}	SDA pin in open drain mode, over temperature and supply, $I_{sink} = 2mA$			0.25	V
SCL Leakage	$I_{SCL, leak}$	$V_{SCL} = 3V, Ta = +85^{\circ}C$			20	μA
SDA Leakage	$I_{SDA, leak}$	$V_{SDA} = 3V, Ta = +85^{\circ}C$			0.25	μA
SCL Capacitance	C_{SCL}				10	pF
SDA Capacitance	C_{SDA}				10	pF
Slave Address	SA	Factory default		5A		hex
Wake up Request	t_{wake}	SDA low	33			ms
SMBus Request	t_{REQ}	SCL low	1.44			ms
Timeout, Low	$T_{imeout, L}$	SCL low	27		33	ms
Timeout, High	$T_{imeout, H}$	SCL high	45		55	μs
Acknowledge Setup	$T_{suac}(MD)$	8-th SCL falling edge, Master	0.5		1.5	μs
Acknowledge Hold	$T_{hdac}(MD)$	9-th SCL falling edge, Master	1.5		2.5	μs
Acknowledge Setup	$T_{suac}(SD)$	8-th SCL falling edge, Slave	2.5			μs
Acknowledge Hold	$T_{hdac}(SD)$	9-th SCL falling edge, Slave	1.5			μs
EEPROM						
Data Retention		$Ta = +85^{\circ}C$	10			years
Erase / Write Cycles		$Ta = +25^{\circ}C$	100K			times
Erase / Write Cycles		$Ta = +85^{\circ}C$	10K			times
Erase Cell Time	T_{erase}			5		ms
Write Cell Time	T_{write}			5		ms

Notes: SMBus and refresh rate timings are given for the nominal calibrate HFO frequency and will vary with this frequency.

1. All PWM timing specifications are given for single PWM output. For the extended PWM output each period has twice the timing specifications. With large capacitive loads lower PWM frequency is recommended. If configured for Thermal relay, output has the PWM DC specifications and can be programmed as push-pull, or NMOS open drain. PWM is free-running; power-up factory default is SMBus.
2. For SMBus compatible interface on 12V refer to the Application information. SMBus compatible interface is described in detail in the SMBus description section. Maximum number of devices on one bus is 100, higher pull-up currents are recommended for higher number of devices, faster bus data transfer rates, and increased reactive loading of the bus.

All voltages are referenced to V_{SS} (ground) unless otherwise noted.

Temperature Sensor Module

10. Computation of Ambient and Object Temperatures

The IR sensor within the unit consists series of thermo-couples (thermopile) linked at cold junctions within the chip substrate and hot junctions. As IR radiation from the target object is absorbed by the membrane it heats or cools. Also keep in mind the temperature of the silicon substrate will also fluctuate due to conduction from the sensor package.

An on board temperature sensor is needed to measure the chip temperature. After measurement of the output of both sensors, the corresponding ambient and object temperatures can be calculated. These calculations are performed by the internal DSP which produces a digital output linearly proportional to measured temperatures. Digital output is constructed using the following formula:

$$V_{ir}(T_a, T_o) = A * (T_o^4 - T_a^4),$$

- **To:** object temperature in absolute Kelvin
- **Ta:** sensor die temperature in absolute Kelvin
- **A:** overall sensitivity.
- **Vir:** output sensor voltage

10.1 Ambient Temperature Ta

The temperature of the sensor die is measured using a PTC or a PTAT element. The data collection and linearization calculations are done on chip and the sensor die temperature is stored via memory.

The sensor is factory calibrated for a range of -40°C to +125 °C with a resolution of 0.02 °C. The calibrated Ta data is found in RAM cell 0x06h, 0x2DE4h corresponds to -38.2 °C (linearization output lower limit) and 0x4DC4h (19908d) corresponds to 125 °C. Conversions can be made from RAM to Ta using the following function:

$$T_a[^\circ K] = T_{areg} \times 0.02, \text{ or } 0.02 \text{ } ^\circ K / \text{ LSB.}$$

10.2 Object Temperature To

The object temperature has a resolution of 0.02 °C and is available via RAM cells 0x07 for Tobj1. To is derived from RAM using the following function:

$$T_o[^\circ K] = T_{oreg} \times 0.02, \text{ or } 0.02 \text{ } ^\circ K / \text{ LSB.}$$

Note that 1LSB corresponds to 0.02Deg and errors are reported by the MSB being high

Example:

1. 0000 => -273.15°C (no error) - min possible return value
2. 0001 => -273.13°C (no error)
3. 0002 => -273.11°C (no error)
4. 3A56 => 25.53°C (no error)
5. 7FFF => 382.19°C (no error) - max possible return value
6. FFFF => Error

Temperature values are calculated using the following steps:

1. Convert hex value to decimal value: 0x4B7Dh = 19325d
2. Divide by 50 19325 / 50 = 386.5 (result is in Kelvin)
3. Convert K to °C: 386.5 - 273.15 = 113.35°C

Temperature Sensor Module

10.3 Calculation Process

The measurements, calculations and linearization are done by the DSP, which executes its program from ROM. Following POR the DSP is initialized using calibration data from EEPROM. During initialization, the number of IR sensors and which sensor will be read are defined. Measurements, compensation and linearization routines are run in a closed loop afterwards.

Ambient temperature processing includes:

- Offset measurement with fixed length FIR filter.
- Additional filtering with fixed length IIR filter.
The result is stored into RAM as TOS.
- Temperature sensor measurement using programmable length FIR *.
- Offset compensation.
- Additional processing with programmable length IIR **.
The result is stored into RAM as TD.
- Calculation of the ambient temperature.
The result is stored into RAM as TA.

Processing of the object temperature is done in three parts. IR2 within the object temperature loop is executed only if two IR detectors are used.

IR offset:

- Offset measurement with a fixed length FIR.
- Additional filtering with a fixed length IIR.
The result is stored into RAM as IROS.
- Gain measurement with fixed length FIR filter.
- Offset compensation.
- Additional gain filtering with fixed length IIR.
The result into RAM as IRG.
- Gain compensation calculation.
The result is stored into RAM as KG.

Object temperature:

IR1 sensor:

- IR sensor measurement with programmable length FIR filter *.
- Offset compensation.
- Gain compensation.
- Filtering with programmable length IIR filter**.
The result is stored into RAM as IR1_D.
- Calculation of the object temperature.
The result is available in RAM as TOBJ1.

IR2 sensor:

- IR sensor measurement with programmable length FIR filter *.
- Offset compensation
- Gain compensation
- Filtering with programmable length IIR filter**.
The result is stored into RAM as IR2_D
- Calculation of the object temperature.
The result is available in RAM as TOBJ2.

PWM calculation:

- Recalculate the data for PWM with 10 bit resolution.
- Load data into PWM module.

Note:* The measurements with programmable filter length for FIR filter use the same EEPROM cells for N.

*Note**:* The IIR filter with programmable filter length uses the same EEPROM cells for L.
See figure 14 for N and L.

Temperature Sensor Module

The device also preserves its normal operation when configured as a thermal relay and can still be read using the SMBus. Entering SMBus mode from thermal relay configuration and PWM mode is the same.

An example application for this feature would be a temperature monitoring system that is activated by the TSM reaching a specific temperature in thermal relay mode. The device could then be read using SMBus until the temperature drops below a certain point at which point a reset condition (enter and exit sleep) could return the device to thermal relay configuration.

Example:

threshold 5 °C => $(5 + 273.15) * 100 = 27815d = 0x6CA7h$
 hysteresis is 1°C => $1 * 100 = 100d = 0x64h$ (smallest possible hysteresis is 0.01°C or 1h)

PWM / SDA pin will be low at object temperature below 4 °C
 PWM / SDA pin will be high at object temperature higher than 6 °C

12. SMBus Compatible 2-wire Protocol

The chip supports a 2-wire serial protocol; built with pins PWM / SDA and SCL.

SCL – digital input, used as the clock for SMBus compatible communication. This pin has the auxiliary function for building an external voltage regulator. When the external voltage regulator is used, the 2-wire protocol is available only if the power supply regulator is overdriven.

PWM / SDA – Digital input / output, used for both the PWM output of the measured object temperature(s) or the serial data input / output for the SMBus. The pin can be programmed in EEPROM to operate as push-pull or open drain NMOS (open drain NMOS is factory default). In SMBus mode SDA is forced to open drain NMOS I/O, push-pull selection bit defines PWM / Thermal relay operation.

Functional Description

The SMBus interface is a 2-wire protocol, allowing communication between the Master Device (MD) and one or more Slave Devices (SD). In the system only one master can be presented at any given time [1]. The TSM can only be used as a slave device.

Generally, the MD initiates the start of data transfer by selecting a SD through the Slave Address (SA).

The MD has read access to the RAM and EEPROM and write access to 9 EEPROM cells (at addresses 0x20h, 0x21h, 0x22h, 0x23h, 0x24h, 0x25h*, 0x2Eh, 0x2Fh, 0x39h). If the access to the TSM is a read operation it will respond with 16 data bits and 8-bit PEC only if its own slave address, programmed in internal EEPROM, is equal to the SA, sent by the master. The SA feature allows connecting up to 100 devices with only 2 wires, unless the system has some of the specific features described in paragraph 5.2 of reference [1]. In order to provide access to any device or to assign an address to a SD before it is connected to the bus system, the communication must start with zero SA followed by low RWB bit. When this command is sent from the MD, the TSM will always respond and will ignore the internal chip code information.

Special care must be taken not to put two TSM devices with the same SD addresses on the same bus as TSM does not support ARP[1].

The MD can force the TSM into low consumption mode "sleep mode" (3 Volt versions only).

Temperature Sensor Module

Read flags like "EEBUSY" (1 – EEPROM is busy with executing the previous write/erase), "EE_DEAD" (1 – there is fatal EEPROM error and this chip is not functional**).

Note*:

This address (0x25) is readable and writable. Bit 3 should not be altered as this will cancel the factory calibration!

Note:**

EEPROM error signaling is implemented in precision grade parts only.

12.1 Differences with the Standard SMBus specification

There are eleven command protocols for standard SMBus interface. The TSM supports only two of them. Not supported commands are:

- Quick Command
- Byte commands - Sent Byte, Receive Byte, Write Byte and Read Byte
- Process Call
- Block commands – Block Write and Write-Block Read Process Call

Supported commands are:

- Read Word
- Write Word

12.2 Detailed Description

The PWM/SDA pin of TSM can operate also as PWM output, depending on the EEPROM settings. If PWM is enabled, after POR the PWM/SDA pin is directly configured as PWM output. The PWM mode can be avoided and the pin can be restored to its Data function by a special command. Both modes are treated separately from this point forward.

12.2.1 Bus Protocol

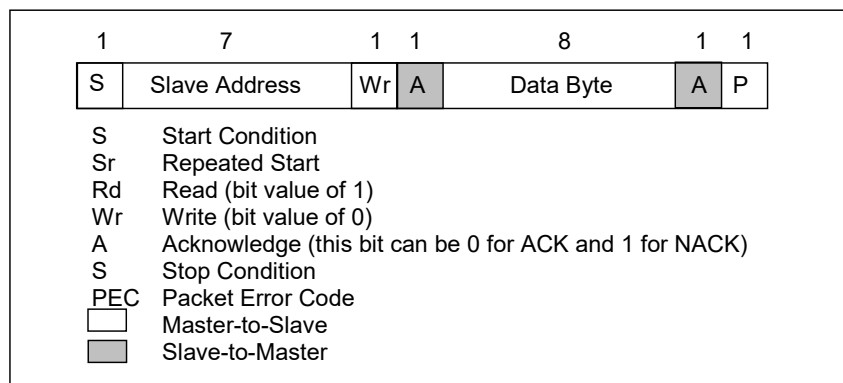

After every 8 bits received by the Slave Devices (SD) an ACK/NACK takes place. When a Master Device (MD) initiates communication, it first sends the address of the slave and only the SD which recognizes the address will ACK, the rest will remain silent. In case the SD NACKs one of the bytes, the MD should stop the communication and repeat the message. A NACK could be received after the PEC. This means that there is an error in the

Temperature Sensor Module

received message and the MD should try sending the message again. The PEC calculation includes all bits except the START, REPEATED START, STOP, ACK, and NACK bits. The PEC is a CRC-8 with polynomial X^8+X^2+X+1 . The Most Significant Bit of every byte is transferred first.

12.2.2 SMBus Read Word

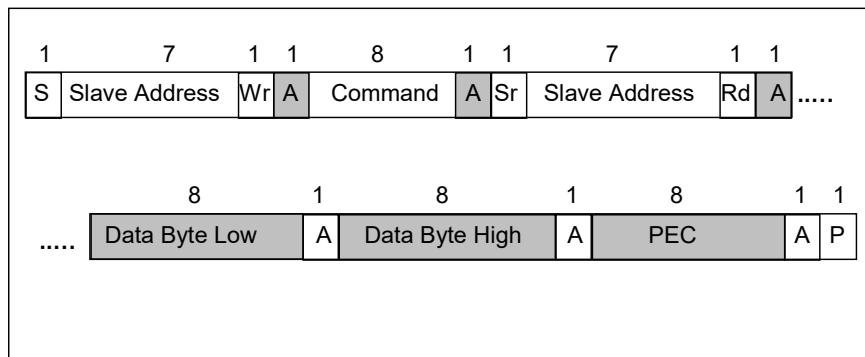

Read Word (depending on command – RAM or EEPROM).

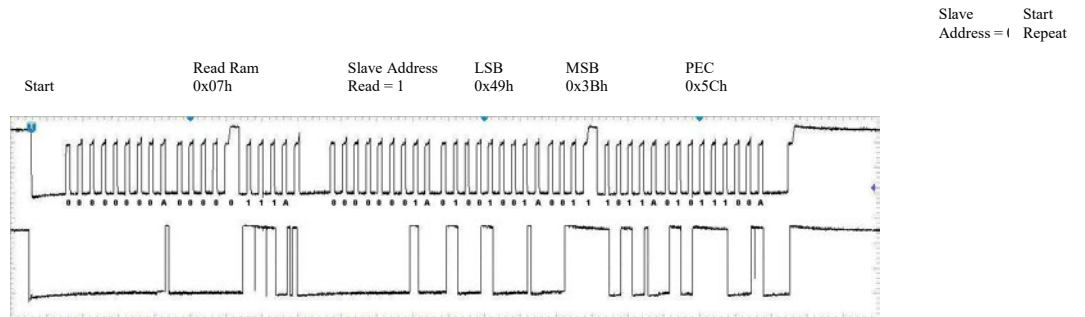
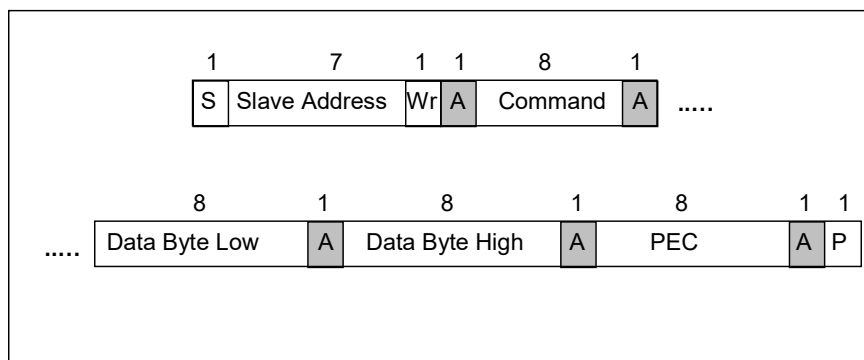

Figure 6. Read Tobj1.

Read RAM 0x07h, results = 0x3B49h, PEC = 0x5Ch.

Temperature Sensor Module

12.2.3 SMBus Write Word



Write Word (depending on command – RAM or EEPROM).

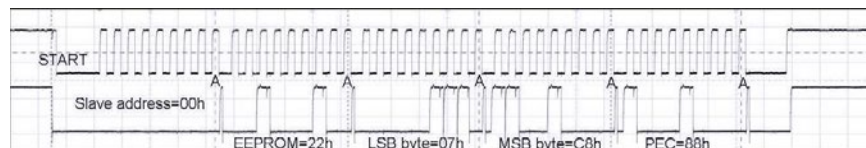

Figure 7. Write PWMCTRL after writing zero's to erase EEPROM cell.

Write 0xC807 to EEPROM address 0x22h, PEC = 0x88h.

12.3 Bus Timing

The TSM meets all the timing specifications of the SMBus [1]. The maximum frequency of the TSM SMBus is 100 KHz and the minimum is 10 KHz.

The specific timings in TSM's SMBus are:

SMBus Request (t_{REQ}) is the time that the SCL should be forced low in order to switch TSM from PWM mode to SMBus mode;

Temperature Sensor Module

Timeout L is the maximum allowed time for SCL to be low. After this time the TSM will reset its communication block and will be ready for new communication;

Timeout H is the maximum time for which it is allowed for SCL to be high during communication. After this time TSM will reset its communication block assuming that the bus is idle (according to the SMBus specification).

Tsuac(SD) is the time after the eighth falling edge of SCL that TSM will force PWM / SDA low to acknowledge the last received byte.

Thdac(SD) is the time after the ninth falling edge of SCL that TSM will release the PWM / SDA (so the MD can continue with the communication).

Tsuac(MD) is the time after the eighth falling edge of SCL that TSM will release PWM / SDA (so that the MD can acknowledge the last received byte).

Thdac(MD) is the time after the ninth falling edge of SCL that TSM will take control of the PWM / SDA (so it can continue with the next byte to transmit).

The indexes MD and SD for the latest timings are used – MD when the master device is making acknowledge; SD when the slave device is making acknowledge. For other timings see [1].

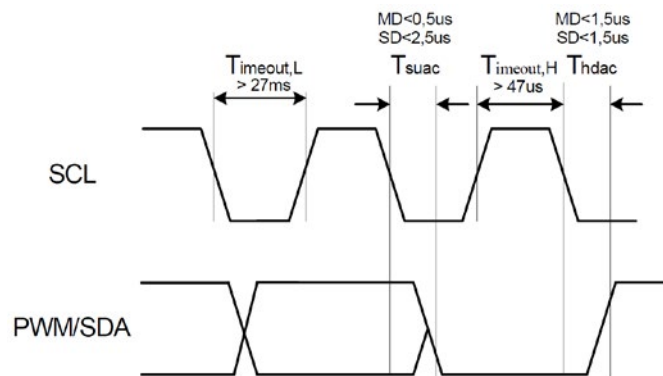

Figure 8. SMBus timing.

Temperature Sensor Module

12.4 SCL Zener Diode

The auxiliary functions of the SCL pin adds undershoot to the clock pulse (5 Volt versions only) as shown in the picture below (see Figure 9). This undershoot is caused by the transient response of the on-chip synthesized Zener diode. Typical duration of undershoot is approximately 15 μ s. An increased reactance of the SCL line is likely to increase this effect. Undershoot does not affect the recognition of the SCL rising edge by the TSM, but may affect proper operation of non TSM slaves on the same bus.

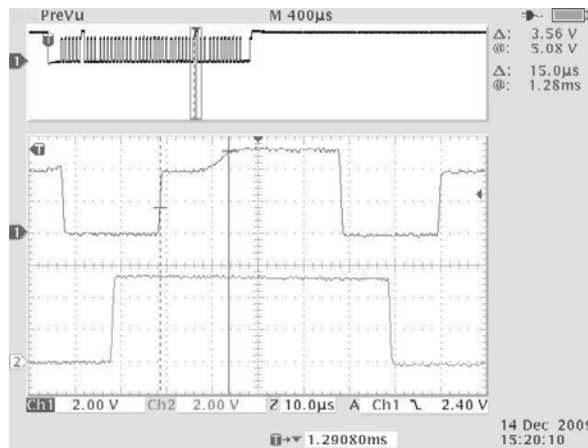

Figure 9. Undershoot of SMBUS SCL line due to the on chip zener diode. (5 Volt versions only)

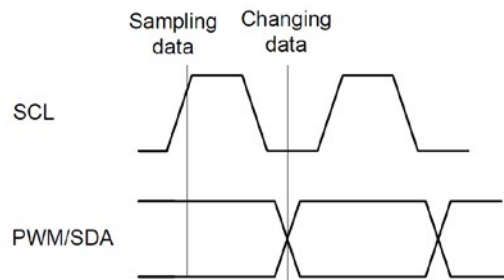

Figure 10. Bit transfer on SMBus.

The data on PWM / SDA must be changed when SCL is low (min 300 ns after the falling edge of SCL). The data is fetched by both MD and SDs on the rising edge of the SCL. The recommended timing for changing data is in the middle of the period when the SCL is low.

Temperature Sensor Module

12.5 Commands

RAM and EEPROM can be read both with 32 x 16 sizes. If the RAM is read, the data is divided by two, due to a sign bit in RAM (for example, Tobj1 - RAM address 0x07h will sweep between 0x27ADh to 0x7FFF as the object temperature rises from -70.01°C to +382.19°C). The MSB read from RAM is an error flag (active high) for the linearized temperatures (Tobj1, Tobj2 and Ta). The MSB for the raw data (e.g. IR sensor1 data) is a sign bit (sign and magnitude format). A write of 0x0000 must be done prior to writing in EEPROM in order to erase the EEPROM cell content. Refer to EEPROM detailed description for factory calibration EEPROM locations that need to be kept unaltered.

Opcode	Command
000x xxxx*	RAM Access
001x xxxx*	EEPROM Access
1111_0000**	Read Flags
1111_1111	Enter Sleep Mode

*Note**: The xxxx represent the 5 LSBits of the memory map address to be read / written.

*Note***: Behaves like read command. The TSM returns PEC after 16 bits data of which only 4 are meaningful and if the MD wants it, it can stop the communication after the first byte.

The difference between (RAM or EEPROM) read to Read Flags is that the latter does not have a repeated start bit.

Flags read are:

Data[15] – EEBUSY – the previous write/erase EEPROM access is still in progress. High active.

Data[14] – unused

Data[13] – EE_DEAD – EEPROM double error has occurred. High active.

Data[12] – INIT – POR initialization routine is still ongoing. Low active.

Data[11] – not implemented.

Data[10..0] – all zeros.

Flags read is a diagnostic feature. The TSM can be used regardless of these flags.

12.6 Sleep Mode

The TSM can enter in Sleep Mode via the command "Enter SLEEP mode" sent via the SMBus interface. This mode is not available for the 5 Volt supply version. To limit the current consumption to 2.5 µA (typical), the SCL pin should be kept low during sleep. TSM goes back into power-up default mode (via POR reset) by setting SCL pin high and then PWM / SDA pin low for at least $t_{DDQ} > 33$ ms.

If EEPROM is configured for PWM (EN_PWM is high), the PWM interface will be selected after awakening and if PWM control [2], PPODB is 1 the TSM will output a PWM pulse train with push-pull output.

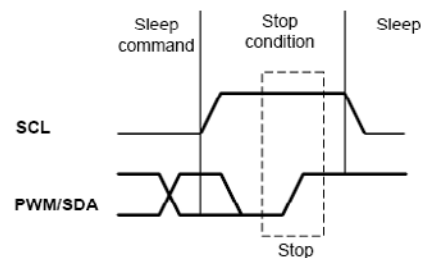

Figure 11. Entering Sleep Mode.

Temperature Sensor Module

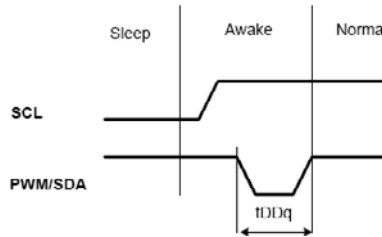

Figure 12. Exiting Sleep Mode.

After exit from Sleep Mode data is available after 0.25 seconds (typ). For the first measurement the IIR filter is skipped, all measurements afterwards pass the digital filtering as configured in EEPROM.

13. Pulse Width Modulation (PWM)

The TSM can be read via PWM or SMBus compatible interface. Selection of PWM output is done in EEPROM configuration (factory default is SMBus). PWM output has two programmable formats, single and dual data transmission, providing single wire reading of two temperatures (object and ambient). The PWM period is derived from the on-chip oscillator and is programmable.

Config Register[5:4]	PWM1 data	PWM2 data	$T_{min,1}$	$T_{max,1}$	$T_{min,2}$	$T_{max,2}$
00	Ta	Tobj1	$Ta_{range, L}$	$Ta_{range, H}$	To_{min}	To_{max}
01	Ta	Tobj2	$Ta_{range, L}$	$Ta_{range, H}$	To_{min}	To_{max}
11	Tobj1	Tobj2	To_{min}	To_{max}	To_{min}	To_{max}
10*	Tobj2	Undefined	To_{min}	To_{max}	N.A.	N.A.

Note: Serial data functions (2-wire / PWM) are multiplexed with a thermal relay function (described in the "Thermal relay" section).

* not recommended for extended PWM format operation

Temperature Sensor Module

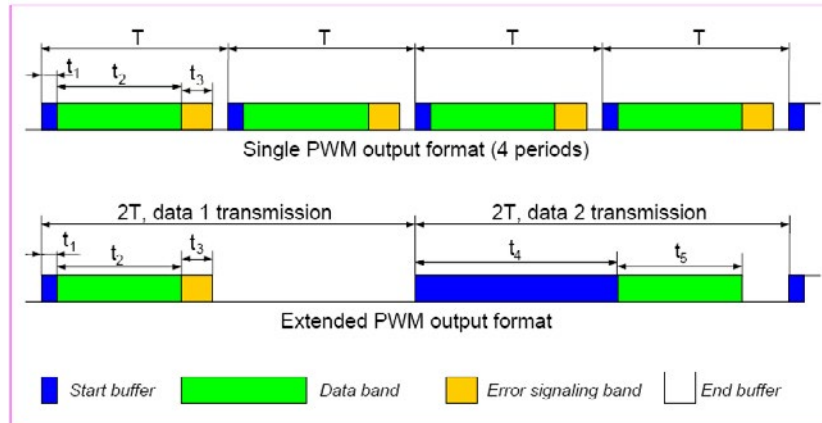

Figure 13. Pulse Width Modulation timing.

13.1 Single PWM Format

In single PWM output mode the settings for PWM1 data only are used. The temperature reading can be calculated from the signal timing as:

$$T_{out} = [(2t_2 / T) * (T_{max} - T_{min})] + T_{min}$$

where T_{min} and T_{max} are the corresponding rescale coefficients in EEPROM for the selected temperature output (T_a , object temperature range is valid for both T_{obj1} and T_{obj2} as specified in the previous table) and T is the PWM period. T_{out} is T_{obj1} , T_{obj2} or T_a according to Config Register [5:4] settings.

The different time intervals $t_1...t_4$ have following meaning:

t_1 : Start buffer. During this time the signal is always high. $t_1 = 0.125 * T$

(T is the PWM period, refer to Figure. 10).

t_2 : Valid Data Output Band, $0...1/2T$. PWM output data resolution is 10 bit.

t_3 : Error band – information for fatal error in EEPROM (double error detected, not correctable). $t_3 = 0.25 * T$.

Therefore a PWM pulse train with a duty cycle of 0.875 will indicate a fatal error in EEPROM (for single PWM format). OVF means Overflow, UNF means Underflow and FE mean Fatal Error

Example:

$T_{obj1} => Config Reg[5:4] = 11$

$To_{min} = 0^{\circ}C \Rightarrow To_{min}[EEPROM] = 100 * (To_{min} + 273.15) = 0x6AB3h$

$To_{max} = +50^{\circ}C \Rightarrow To_{max}[EEPROM] = 100 * (To_{max} + 273.15) = 0x7E3Bh$

Captured PWM high duration is $0.495 * T \Rightarrow t_2 = (0.495 - 0.125) * T = 0.370 * T \Rightarrow$

measured object temperature = $2 * 0.370 * (50^{\circ}C - 0^{\circ}C) + 0^{\circ}C = +37.0^{\circ}C$.

Temperature Sensor Module

13.2 Extended PWM Format

The PWM format for extended PWM is shown in Figure 14. Note that with bits DUAL[5:1] > 00h each period will be outputted 2N + 1 times, where N is the decimal value of the number written in DUAL[5:1] (DUAL[5:1] = PWM control & clock [8:4]), like shown on Figure 14.

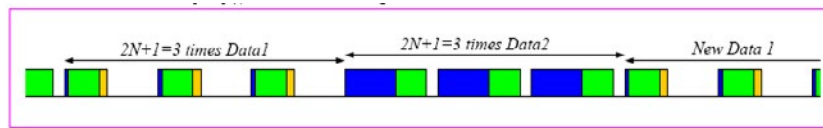

Figure 14. Extended PWM format with DUAL[5:1] = 0x01h (2 repetitions for each data).

The temperature transmitted in Data 1 field can be calculated using the following equation:

$$T_{out1} = [(2t_2 / T) * (T_{max1} - T_{min1})] + T_{min1}$$

For Data 2 field the equation is:

$$T_{out2} = [(2t_5 / T) * (T_{max2} - T_{min2})] + T_{min2}$$

Where T_{min1} , T_{max1} , T_{min2} and T_{max2} are given in previous table, $t_2 = t_{high1} - t_1$, and $t_5 = t_{high2} - t_4$.

Time bands are: $t_1 = 0.125 * T$, $t_3 = 0.25 * T$ and $t_4 = 1.125 * T$. As shown in Figure 11, in extended PWM format the period is twice the period for the single PWM format. All equations provided herein are given for the single PWM period T. The EEPROM Error band signaling will be 43.75% duty cycle for Data1 and 93.75% for Data2.

Note: EEPROM error signaling is implemented in precision grade parts only.

Example:

Configuration: Ta : Tobj1 @ Data1 : Data2 => Config Reg[5:4] = 00,

$$\begin{aligned} T_{a_{min}} = -5^{\circ}\text{C} & \Rightarrow T_{a_{range, L}} [\text{EEPROM}] = 100 * (T_{a_{min}} + 38.2) / 64 = 0x34h, \\ T_{a_{max}} = +105^{\circ}\text{C} & \Rightarrow T_{a_{range, H}} [\text{EEPROM}] = 100 * (T_{a_{max}} + 38.2) / 64 = 0xE0h, \\ & T_{a_{range}} [\text{EEPROM}] = 0xE034h \end{aligned}$$

$$\begin{aligned} T_{o_{min}} = 0^{\circ}\text{C} & \Rightarrow T_{o_{min}} [\text{EEPROM}] = 100 * (T_{o_{min}} + 273.15) = 0x6AB3h \\ T_{o_{max}} = +50^{\circ}\text{C} & \Rightarrow T_{o_{max}} [\text{EEPROM}] = 100 * (T_{o_{max}} + 273.15) = 0x7E3Bh \end{aligned}$$

Captured high durations are $0.13068 * (2T)$ and $0.7475 * (2T)$, where 2T is each captured PWM period. Time band t_4 is provided for reliable determination between Data1 and Data2 data fields. Thus Data1 is represented by $0.13068 * (2T)$ and Data2 – by $0.7475 * (2T)$, and the temperatures can be calculated as follows:

$$\begin{aligned} t_2 / T = (t_{high1} / T) - 0.125 = 0.13636 & \Rightarrow T_a = +25.0^{\circ}\text{C}, \\ t_5 / T = (t_{high2} / T) - 1.125 = 0.370 & \Rightarrow T_{obj1} = +37.0^{\circ}\text{C}. \end{aligned}$$

Temperature Sensor Module

13.3 Altering the PWM Output Temperature Range

Calculated ambient and object temperatures are stored via RAM with a resolution of 0.01 °C (16 bit). The PWM utilizes a 10-bit word to rescale the transmitted temperature to fit the desired range. This range is set by 2 cells in the EEPROM for T_o ($T_{o_{min}}$ & $T_{o_{max}}$) and 1 cell for T_a ($T_{a_{range}}$, being, 8MSB for $T_{a_{max}}$ and 8LSB for $T_{a_{min}}$). The output range for T_o can be programmed within an accuracy of 0.01 °C, and T_a within 0.64 °C.

The following equation is used to rescale object data for PWM:

$$T_{PWM(obj)} = (T_{RAM} - T_{MIN(EEPROM)}) / K_{PWM(obj)},$$

$$K_{PWM(obj)} = (T_{MAX(EEPROM)} - T_{MIN(EEPROM)}) / 1023$$

The T_{RAM} is the linearized T_{obj} . Non PWM is 16-bit 0x0000...0xFFFFh, with 0x0000h for -273.15°C and 0xFFFFh for +382.2°C. In PWM mode the output is a 10-bit word, in which 0x00h corresponds to $T_{o_{min}}$ [°C], and 0x3FFh corresponds to $T_{o_{max}}$ [°C]. The LSB corresponds to:

$$(T_{o_{MAX}} - T_{o_{MIN}}) / 1023$$

$$T_{MIN(EEPROM)} = T_{MIN} * 100 \text{ LSB}$$

$$T_{MAX(EEPROM)} = T_{MAX} * 100 \text{ LSB}$$

The following equation is used to rescale ambient data for PWM:

$$T_{PWM(ambient)} = (T_{RAM} - T_{MIN(EEPROM)}) / K_{PWM(ambient)},$$

$$K_{PWM(ambient)} = (T_{MAX(EEPROM)} - T_{MIN(EEPROM)}) / 1023$$

Again the result is a 10-bit word, where 0x00h corresponds to -38.2 °C (lowest T_a that can be read via PWM), 0x3FFh corresponds to 125 °C (highest T_a that can be read via PWM).

The LSB corresponds to:

$$(T_{MAX} - T_{MIN}) / 1023$$

$$T_{MIN(EEPROM)} = [T_{MIN} - (-38.2)] * (100 / 64) \text{ LSB}$$

$$T_{MAX(EEPROM)} = [T_{MAX} - (-38.2)] * (100 / 64) \text{ LSB}$$

Temperature Sensor Module

13.4 Switching Between PWM and SMBus Communication

13.4.1 PWM is Enabled

The diagram below shows the way of switching to SMBus if PWM is enabled (factory programmed POR default for TSM is SMBus, PWM disabled). Note that the SCL pin needs to be kept high in order to use PWM.

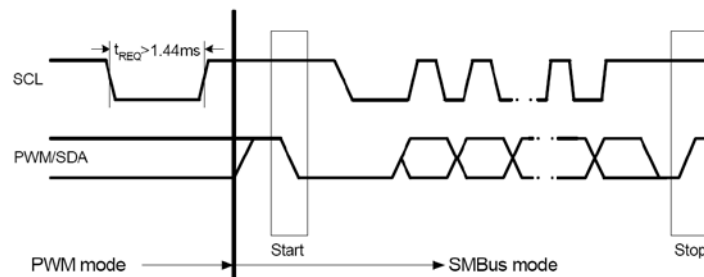

Figure 15. Switching from PWM mode to SMBus mode.

13.4.2 Request Condition

If PWM is enabled, the TSM's SMBus Request condition is needed to disable PWM and reconfigure PWM/SDA pin before starting SMBus communication. Once PWM is disabled, it can be only enabled by switching the supply OFF – ON or exit from Sleep Mode. The TSM's SMBus request condition requires forcing LOW the SCL pin for period longer than the request time ($t_{REQ} > 1,44ms$). The SDA line value is ignored in this case.

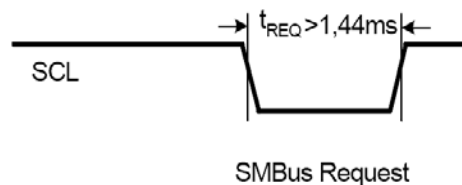

Figure 16. Request (switch to SMBus) condition.

13.4.3 PWM is Disabled

If PWM is disabled by means of EEPROM the PWM/SDA pin is directly used for the SMBus purposes after POR. **Request condition should not be sent in this case.**

Temperature Sensor Module

14. Standard Information Regarding Manufacturability of TSM with Soldering Processes

Our products are classified and qualified regarding soldering technology, solderability and moisture sensitivity level according to following test methods:

Wave Soldering THD's (Through Hole Devices)

- EIA/JEDEC JESD22-B106 and EN60749-15
Resistance to soldering temperature for through-hole mounted devices

Iron Soldering THD's (Through Hole Devices)

- EN60749-15
Resistance to soldering temperature for through-hole mounted devices

Solderability THD's (Through Hole Devices)

- EIA/JEDEC JESD22-B102 and EN60749-21
Solderability

For all soldering technologies deviating from above mentioned standard conditions (regarding peak temperature, temperature gradient, temperature profile etc) additional classification and qualification tests have to be agreed upon with Dexter Research Center Inc.

DRC is contributing to global environmental conservation by promoting **lead free** solutions. For more information on qualifications of **RoHS** compliant products please visit our website:

www.dexterresearch.com

All version of the TSM are RoHS compliant

Temperature Sensor Module

15. Applications Information

Use of the TSM Thermometer in SMBus Configuration

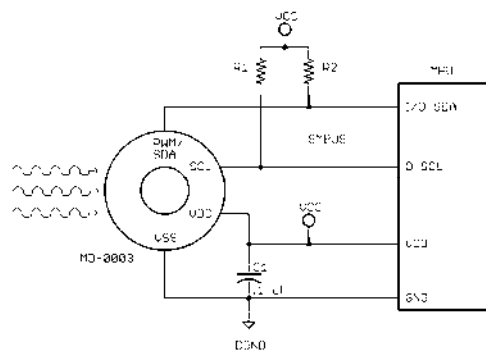

Figure 17. TSM SMBus connection.

Connection of TSM to SMBus with 3.3 V power supply. The TSM has diode clamps SDA/SCL to Vdd so it is necessary to provide TSM with power in order not to load the SMBus lines.

Use of multiple TSMs in SMBus configuration

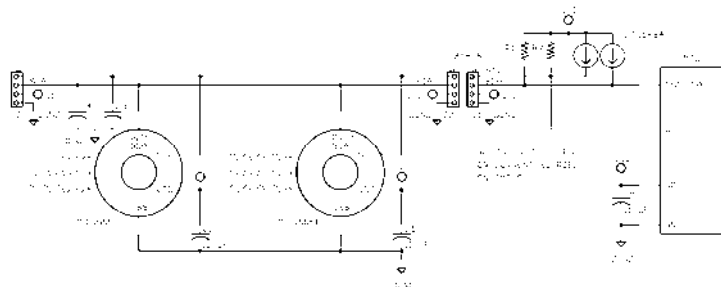

Figure 18. Use of multiple TSM devices in SMBus network.

Dexter's TSM supports a 7-bit slave address in EEPROM, allowing up to 100 devices to be read with just two common wires. Current source pull-ups (such as LTC1694) may be preferred with higher capacitive loading on the bus (C3 and C4 represent the lines' parasitic losses), while the simple resistive pull-up design (R1 & R2) provides a low cost advantage.

Temperature Sensor Module

PWM Output Operation

Using the PWM output mode of the TSM is very simple, as shown in Figure 19.

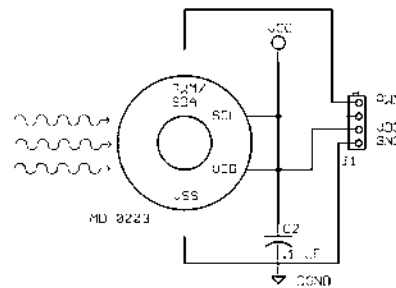

Figure 19. Connection of TSM for PWM output mode.

The PWM mode is free-running after POR when configured in EEPROM. The SCL pin must be forced high (can be shorted to Vdd pin) for PWM mode operation. A pull-up resistor can be used to preserve the option for SMBus operation while having PWM as a default as is shown on Figure 20.

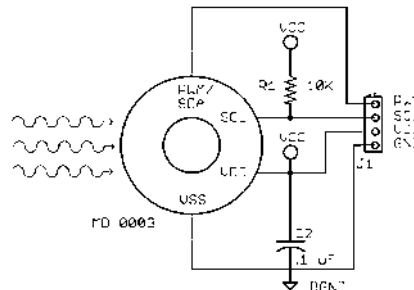

Figure 20. PWM output with SMBus available.

The PWM mode needs to be written as the POR default in EEPROM. Then for PWM operation the SCL line can be high impedance, forced high, or even not connected. The pull-up resistor R1 will ensure there is a high level on the SCL pin and the PWM POR default will be active. SMBus is still available (for example – for further reconfiguration of the TSM, or sleep mode power management) as there are pull-up resistors on the SMBus lines anyway. PWM can be configured as open drain NMOS or a push-pull output. In the case of open drain external pull-up will be needed. This allows cheap level conversion to lower logic high voltage. Internal pull-ups present in many MCUs can also be used.

Temperature Sensor Module

Thermal Alert / Thermostat

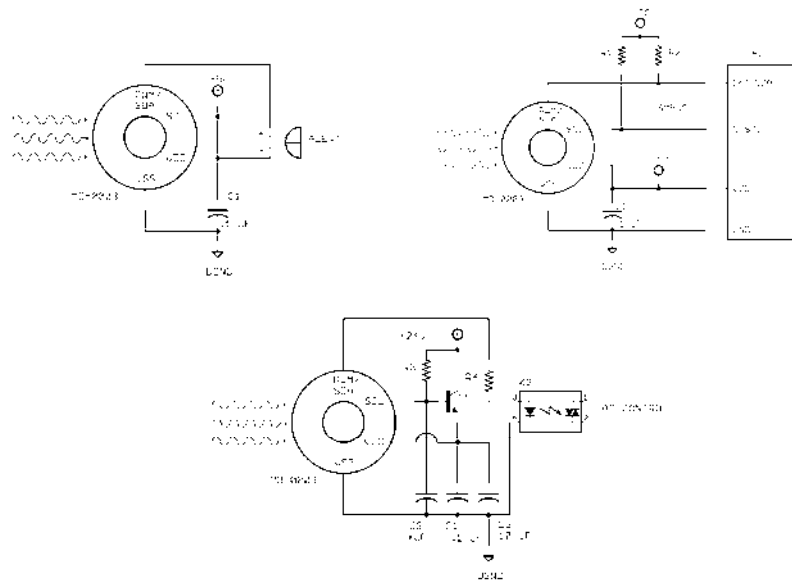

Figure 21. Thermal alert/thermostat applications of TSM.

The TSM can be configured in EEPROM to operate as a thermal relay. A non-contact freezing or boiling prevention with 1 mA quiescent current can be built with two components only the TSM and a capacitor.

The PWM/SDA pin can be programmed as a push-pull or open drain NMOS, which can trigger an external device, such as a relay (refer to electrical specifications for load capability), buzzer, RF transmitter or a LED.

This feature allows very simple thermostats to be built without the need of any MCU and zero design overhead required for firmware development. In conjunction with a MCU, this function can operate as a system alert that wakes up the MCU. Both object temperature and sensor die temperature can also be read in this configuration.

Temperature Sensor Module

High Voltage Source Operation

As a standard, the module MD-0003 and MD-0005 work with a supply voltage of 5 Volt. In addition, thanks to the integrated internal reference regulator available at pin SCL/Vz, these modules can easily be powered from higher voltage source (like VDD = 8 V...16 V). Only a few external components as depicted in the diagram below are required to achieve this.

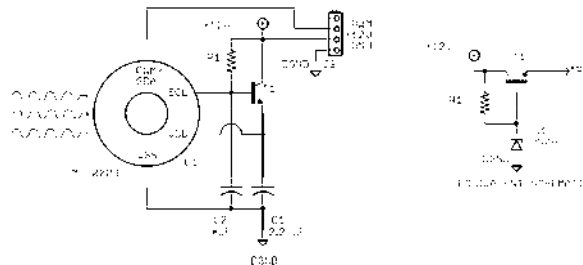

Figure 22. 12 V regulator implementation.

With the second (synthesized Zener diode) function of the SCL/Vz pin used, the 2-wire interface function is available only if the voltage regulator is overdriven (5 V regulated power is forced to Vdd pin).

Application Comments

Significant **contamination** at the optical input side (sensor filter) might cause unknown additional filtering/distortion of the optical signal and therefore result in unspecified errors.

IR sensors are inherently susceptible to errors caused by **thermal gradients**. There are physical reasons for these phenomena and, in spite of the careful design of the TSM, it is recommended not to subject the TSM to heat transfer and especially transient conditions.

Upon **power-up** the TSM passes embedded checking and calibration routines. During these routines the output is not defined and it is recommended to wait for the specified POR time before reading the module. Very slow power-up may cause the embedded POR circuitry to trigger on inappropriate levels, resulting in unspecified operation and this is not recommended.

The TSM is designed and calibrated to operate as a non-contact thermometer in **settled conditions**. Using the thermometer in a very different way will result in unknown results.

Capacitive loading on a SMBus can degrade the communication. Some improvement is possible with use of current sources compared to resistors in pull-up circuitry. Further improvement is possible with specialized commercially available bus accelerators. With the TSM additional improvement is possible by increasing the pull-up current (decreasing the pull-up resistor values). Input levels for SMBus compatible mode have higher overall tolerance than the SMBus specification, but the output low level is rather low even with the high-power SMBus specification for pull-up currents. Another option might be to go for a slower communication (clock speed), as the TSM implements Schmidt triggers on its inputs in SMBus compatible mode and is therefore not really sensitive to rise time of the bus (it is more likely the rise time to be an issue than the fall time, as far as the SMBus systems are open drain with pull-up).

Temperature Sensor Module

For **ESD protection** there are clamp diodes between the Vss and Vdd and each of the other pins. This means that the TSM might draw current from a bus in case the SCL and/or SDA is connected and the Vdd is lower than the bus pull-ups' voltage.

In **12 V powered systems SMBus usage is constrained** because the SCL pin is used for the Zener diode function. Applications where the supply is higher than 5 volts should use the PWM output or an external regulator. Nevertheless, in 12 V-powered applications, the TSM can be programmed (configured and customized) by forcing the Vdd to 5 volts externally and running the SMBus communication.

Sleep mode is available in MD-0006 and MD-0007. This mode is entered and exited via the SMBus compatible 2-wire communication. On the other hand, the extended functionality of the SCL pin yields in increased leakage current through that pin. As a result, this pin needs to be forced low in power-down mode and the pull-up on the SCL line needs to be disabled in order to keep the overall power drain in power-down really small.

The **PWM pin is not designed for direct drive of inductive loads** (such as electro-magnetic relays). Some drivers need to be implemented for higher load, and auxiliary protection might be necessary even for light but inductive loading.

It is possible to use the TSM in applications, powered directly from the AC line (transformer less). In such cases it is very important not to forget that **the metal package of the sensor is not isolated** and therefore may occur to be connected to that line, too. Dexter Research Center Inc. cannot be responsible for any application like this and highly recommends not using the TSM in that way.

Power dissipation within the package may affect performance in two ways: by heating the "ambient" sensitive element significantly beyond the actual ambient temperature, as well as by causing gradients over the package that will inherently cause thermal gradient over the cap. Loading the outputs also causes increased power dissipation. In case of using the MD-0003 and MD-0005 internal zener voltage feature, the regulating external transistor should not cause heating of the TO-5 package.

High capacitive load on a PWM line will result in significant charging currents from the power supply, bypassing the capacitor and therefore causing EMC, noise, level degradation and power dissipation problems. A simple option is adding a series resistor between the PWM / SDA pin and the capacitive loaded line, in which case timing specifications have to be carefully reviewed. For example, with a PWM output that is set to 1.024 ms and the output format that is 11 bit, the time step is 0.5 μ s and a settling time of 2 μ s would introduce a 4 LSBs error.

Power supply decoupling capacitor is needed as with most integrated circuits. TSM is a mixed-signal device with sensors, small signal analog parts, digital parts and I/O circuitry. In order to keep the noise low power supply switching noise needs to be decoupled. High noise from external circuitry can also affect noise performance of the device. In many applications a 100 nF SMD ceramic capacitor close to the Vdd and Vss pins would be a good choice. It should be noted that not only the trace to the Vdd pin needs to be short, but also the one to the Vss pin. Using a TSM with short pins improves the effect of the power supply decoupling.

Severe noise can also be coupled within the package from the SCL (in worst cases also from the SDA) pin. This issue can be solved by using PWM output. Also the PWM output can pass additional filtering (at lower PWM frequency settings). With a simple LPF RC network added also increase of the ESD rating is possible.

16. ESD Precautions

Electronic semiconductor products are sensitive to Electro Static Discharge (ESD). Always observe Electro Static Discharge control procedures whenever handling semiconductor products.

Temperature Sensor Module

17. Package Information

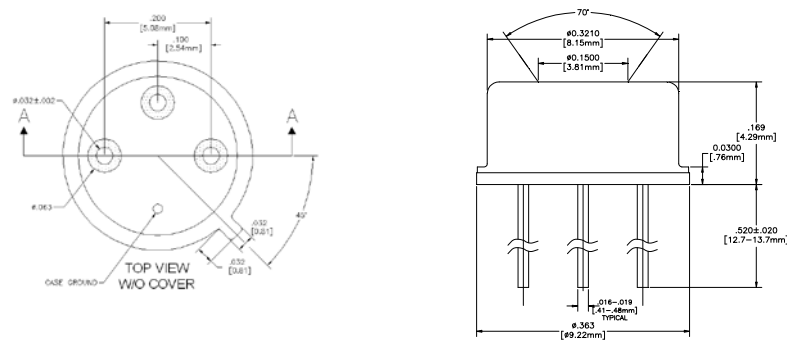

Figure 23. TSM package, 70 deg FOV (MD-0003, MD-0006, MD-0008).

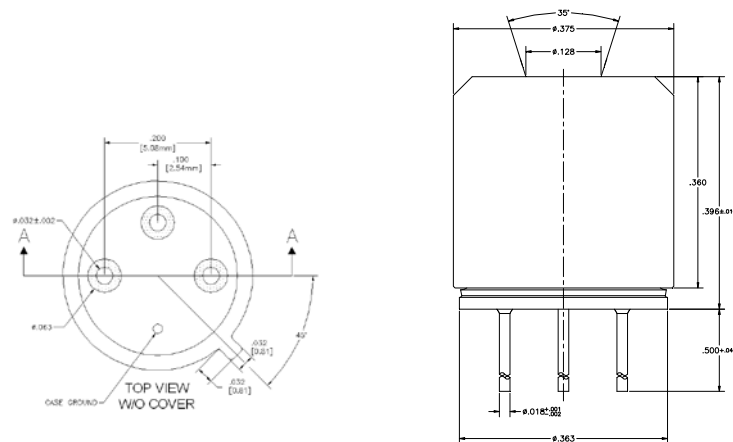

Figure 24. TSM package, 35 deg FOV (MD-0005, MD-0007).

18. References

- [1] **System Management Bus (SMBus) Specification** Version 2.0 August 3, 2000
SBS Implementers Forum Copyright . 1994, 1995, 1998, 2000

Temperature Sensor Module

Duracell, Inc., Energizer Power Systems, Inc., Fujitsu, Ltd., Intel Corporation, Linear Technology Inc., Maxim Integrated Products, Mitsubishi Electric Semiconductor Company, PowerSmart, Inc., Toshiba Battery Co. Ltd., Unitrode Corporation, USAR Systems, Inc.

19. Disclaimer

Devices sold by Dexter Research Center Inc (DRC hereafter) are covered by the warranty and patent indemnification provisions appearing in its Terms of Sale. DRC makes no warranty, express, statutory, implied, or by description regarding the information set forth herein or regarding the freedom of the described devices from patent infringement.

DRC reserves the right to change specifications and prices at any time and without notice. Therefore, prior to designing this product into a system, it is necessary to check with DRC for current information. This product is intended for use in normal commercial applications. Applications requiring extended temperature range, unusual environmental requirements, or high reliability applications, such as military, medical life-support or life-sustaining equipment are specifically not recommended without additional processing by DRC for each application.

The information furnished by DRC is believed to be correct and accurate. However, DRC shall not be liable to recipient or any third party for any damages, including but not limited to personal injury, property damage, loss of profits, loss of use, interrupt of business or indirect, special incidental or consequential damages, of any kind, in connection with or arising out of the furnishing, performance or use of the technical data herein. No obligation or liability to recipient or any third party shall arise or flow out of DRC' rendering of technical or other services.

ISO 9001:2008 Certified

20. Abbreviations

PTAT	Proportional To Absolute Temperature sensor (package temperature)
PTC	Positive Temperature Coefficient sensor (package temperature)
POR	Power On Reset
HFO	High Frequency Oscillator (RC)
DSP	Digital Signal Processing
FIR	Finite Impulse Response. Digital filter
IIR	Infinite Impulse Response. Digital filter
IR	Infra-Red
PWM	Pulse Width Modulation
DC	Duty Cycle (of the PWM) ; Direct Current (for settled conditions specifications)
FOV	Field Of View
SDA,SCL	Serial DAta, Serial CLock – SMBus compatible communication pins
Ta	Ambient Temperature, measured from the chip – (the package temperature)
To	Object Temperature, 'seen' from IR sensor
ESD	Electro-Static Discharge
EMC	Electro-Magnetic Compatibility
TBD	To Be Defined

Temperature Sensor Module

Note: All versions of the Temperature sensor module are sometimes referred to as "the module" or TSM.

21. Revision Table

Version	Modifications	Comment	Date
1		Release	Dec 2009
2	<p>Change ordering info. (page 1), remove -XXXX part number options added MD-0005, MD-0006, MD-0007. Change 90 FOV to 70 FOV to match chart page 31.</p> <p>Change part numbers throughout the document to reflex removal of -XXXX option.</p> <p>Change filter settling chart to provide more information. Page 12.</p> <p>Change $t_{DDq} = 80$ ms to > 33ms page 19.</p>		June 2010
3	<p>Add Overview section with evaluation kit.</p> <p>Update drawings.</p> <p>Change Accuracy section, include Vdd compensation factor.</p>		April 2011