

Datasheet

HCA-200M-20K-C

High-Speed Current Amplifier

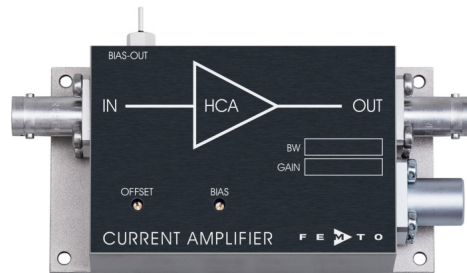

Features	<ul style="list-style-type: none"> • Bandwidth DC ... 200 MHz • Transimpedance (Gain) 2×10^4 V/A • Suitable for Source Capacitance up to 8 pF • Low Equivalent Input Noise Current of 4.9 pA/√Hz 																																																														
Applications	<ul style="list-style-type: none"> • Photodiode and Photomultiplier Amplifier • Spectroscopy • Charge Amplifier • Ionisation Detectors • Pre-amplifier for Lock-Ins, A/D Converters, etc. 																																																														
Specifications	<table border="0"> <tr> <td>Test Conditions</td> <td>$V_s = \pm 15$ V, $T_a = 25^\circ$ C</td> </tr> <tr> <td>Gain</td> <td> <table border="0"> <tr> <td>Transimpedance</td> <td>2×10^4 V/A (@ 50 Ω load)</td> </tr> <tr> <td>Gain Accuracy</td> <td>± 2 %</td> </tr> </table> </td> </tr> <tr> <td>Frequency Response</td> <td> <table border="0"> <tr> <td>Lower Cut-Off Frequency</td> <td>DC</td> </tr> <tr> <td>Upper Cut-Off Frequency (-3 dB)</td> <td> <table border="0"> <tr> <td>200 MHz</td> <td>(± 10 %, @ Csource 2 to 4 pF)</td> </tr> <tr> <td>170 MHz</td> <td>(± 10 %, @ Csource 5 to 8 pF)</td> </tr> </table> </td> </tr> <tr> <td>Max. Source Capacitance</td> <td>8 pF (incl. cable, e.g. typical coax cable 1 pF/cm)</td> </tr> <tr> <td>Rise / Fall Time (10 % - 90 %)</td> <td> <table border="0"> <tr> <td>1.9 ns</td> <td>(@ Csource 2 to 4 pF)</td> </tr> <tr> <td>2.2 ns</td> <td>(@ Csource 5 to 8 pF)</td> </tr> </table> </td> </tr> <tr> <td>Gain Flatness</td> <td>± 0.3 dB</td> </tr> </table> </td> </tr> <tr> <td>Input</td> <td> <table border="0"> <tr> <td>Equ. Input Noise Current</td> <td>4.9 pA/√Hz (@ 10 MHz)</td> </tr> <tr> <td>Equ. Input Noise Voltage</td> <td>0.9 nV/√Hz (@ 10 MHz)</td> </tr> <tr> <td>Equ. Integrated Noise</td> <td>1.0 μA peak-peak</td> </tr> <tr> <td>Input Bias Current</td> <td>12 μA typ.</td> </tr> <tr> <td>Input Bias Current Drift</td> <td>3 nA / °C</td> </tr> <tr> <td>Offset Current Compensation</td> <td>± 100 μA adjustable by offset trimpot</td> </tr> <tr> <td>Input Current Range</td> <td>± 60 μA (for linear amplification)</td> </tr> <tr> <td>Input Offset Voltage</td> <td>< 1 mV</td> </tr> <tr> <td>DC Input Impedance</td> <td>56 Ω (virtual) // 5 pF</td> </tr> </table> </td> </tr> <tr> <td>Output</td> <td> <table border="0"> <tr> <td>Output Voltage Range</td> <td>± 1.2 V (@ 50 Ω load) for linear operation and low harmonic distortion</td> </tr> <tr> <td>Max. Output Voltage Range</td> <td>± 1.7 V (@ 50 Ω load)</td> </tr> <tr> <td>Output Impedance</td> <td>50 Ω (terminate with 50 Ω load for best performance)</td> </tr> </table> </td> </tr> <tr> <td>Bias Output</td> <td> <table border="0"> <tr> <td>Bias Output Voltage Range</td> <td>± 12 V, adjustable by bias trimpot</td> </tr> <tr> <td>Bias Output Impedance</td> <td>10 kΩ // 1 μF</td> </tr> </table> </td> </tr> </table>	Test Conditions	$V_s = \pm 15$ V, $T_a = 25^\circ$ C	Gain	<table border="0"> <tr> <td>Transimpedance</td> <td>2×10^4 V/A (@ 50 Ω load)</td> </tr> <tr> <td>Gain Accuracy</td> <td>± 2 %</td> </tr> </table>	Transimpedance	2×10^4 V/A (@ 50 Ω load)	Gain Accuracy	± 2 %	Frequency Response	<table border="0"> <tr> <td>Lower Cut-Off Frequency</td> <td>DC</td> </tr> <tr> <td>Upper Cut-Off Frequency (-3 dB)</td> <td> <table border="0"> <tr> <td>200 MHz</td> <td>(± 10 %, @ Csource 2 to 4 pF)</td> </tr> <tr> <td>170 MHz</td> <td>(± 10 %, @ Csource 5 to 8 pF)</td> </tr> </table> </td> </tr> <tr> <td>Max. Source Capacitance</td> <td>8 pF (incl. cable, e.g. typical coax cable 1 pF/cm)</td> </tr> <tr> <td>Rise / Fall Time (10 % - 90 %)</td> <td> <table border="0"> <tr> <td>1.9 ns</td> <td>(@ Csource 2 to 4 pF)</td> </tr> <tr> <td>2.2 ns</td> <td>(@ Csource 5 to 8 pF)</td> </tr> </table> </td> </tr> <tr> <td>Gain Flatness</td> <td>± 0.3 dB</td> </tr> </table>	Lower Cut-Off Frequency	DC	Upper Cut-Off Frequency (-3 dB)	<table border="0"> <tr> <td>200 MHz</td> <td>(± 10 %, @ Csource 2 to 4 pF)</td> </tr> <tr> <td>170 MHz</td> <td>(± 10 %, @ Csource 5 to 8 pF)</td> </tr> </table>	200 MHz	(± 10 %, @ Csource 2 to 4 pF)	170 MHz	(± 10 %, @ Csource 5 to 8 pF)	Max. Source Capacitance	8 pF (incl. cable, e.g. typical coax cable 1 pF/cm)	Rise / Fall Time (10 % - 90 %)	<table border="0"> <tr> <td>1.9 ns</td> <td>(@ Csource 2 to 4 pF)</td> </tr> <tr> <td>2.2 ns</td> <td>(@ Csource 5 to 8 pF)</td> </tr> </table>	1.9 ns	(@ Csource 2 to 4 pF)	2.2 ns	(@ Csource 5 to 8 pF)	Gain Flatness	± 0.3 dB	Input	<table border="0"> <tr> <td>Equ. Input Noise Current</td> <td>4.9 pA/√Hz (@ 10 MHz)</td> </tr> <tr> <td>Equ. Input Noise Voltage</td> <td>0.9 nV/√Hz (@ 10 MHz)</td> </tr> <tr> <td>Equ. Integrated Noise</td> <td>1.0 μA peak-peak</td> </tr> <tr> <td>Input Bias Current</td> <td>12 μA typ.</td> </tr> <tr> <td>Input Bias Current Drift</td> <td>3 nA / °C</td> </tr> <tr> <td>Offset Current Compensation</td> <td>± 100 μA adjustable by offset trimpot</td> </tr> <tr> <td>Input Current Range</td> <td>± 60 μA (for linear amplification)</td> </tr> <tr> <td>Input Offset Voltage</td> <td>< 1 mV</td> </tr> <tr> <td>DC Input Impedance</td> <td>56 Ω (virtual) // 5 pF</td> </tr> </table>	Equ. Input Noise Current	4.9 pA/√Hz (@ 10 MHz)	Equ. Input Noise Voltage	0.9 nV/√Hz (@ 10 MHz)	Equ. Integrated Noise	1.0 μA peak-peak	Input Bias Current	12 μA typ.	Input Bias Current Drift	3 nA / °C	Offset Current Compensation	± 100 μA adjustable by offset trimpot	Input Current Range	± 60 μA (for linear amplification)	Input Offset Voltage	< 1 mV	DC Input Impedance	56 Ω (virtual) // 5 pF	Output	<table border="0"> <tr> <td>Output Voltage Range</td> <td>± 1.2 V (@ 50 Ω load) for linear operation and low harmonic distortion</td> </tr> <tr> <td>Max. Output Voltage Range</td> <td>± 1.7 V (@ 50 Ω load)</td> </tr> <tr> <td>Output Impedance</td> <td>50 Ω (terminate with 50 Ω load for best performance)</td> </tr> </table>	Output Voltage Range	± 1.2 V (@ 50 Ω load) for linear operation and low harmonic distortion	Max. Output Voltage Range	± 1.7 V (@ 50 Ω load)	Output Impedance	50 Ω (terminate with 50 Ω load for best performance)	Bias Output	<table border="0"> <tr> <td>Bias Output Voltage Range</td> <td>± 12 V, adjustable by bias trimpot</td> </tr> <tr> <td>Bias Output Impedance</td> <td>10 kΩ // 1 μF</td> </tr> </table>	Bias Output Voltage Range	± 12 V, adjustable by bias trimpot	Bias Output Impedance	10 kΩ // 1 μF
Test Conditions	$V_s = \pm 15$ V, $T_a = 25^\circ$ C																																																														
Gain	<table border="0"> <tr> <td>Transimpedance</td> <td>2×10^4 V/A (@ 50 Ω load)</td> </tr> <tr> <td>Gain Accuracy</td> <td>± 2 %</td> </tr> </table>	Transimpedance	2×10^4 V/A (@ 50 Ω load)	Gain Accuracy	± 2 %																																																										
Transimpedance	2×10^4 V/A (@ 50 Ω load)																																																														
Gain Accuracy	± 2 %																																																														
Frequency Response	<table border="0"> <tr> <td>Lower Cut-Off Frequency</td> <td>DC</td> </tr> <tr> <td>Upper Cut-Off Frequency (-3 dB)</td> <td> <table border="0"> <tr> <td>200 MHz</td> <td>(± 10 %, @ Csource 2 to 4 pF)</td> </tr> <tr> <td>170 MHz</td> <td>(± 10 %, @ Csource 5 to 8 pF)</td> </tr> </table> </td> </tr> <tr> <td>Max. Source Capacitance</td> <td>8 pF (incl. cable, e.g. typical coax cable 1 pF/cm)</td> </tr> <tr> <td>Rise / Fall Time (10 % - 90 %)</td> <td> <table border="0"> <tr> <td>1.9 ns</td> <td>(@ Csource 2 to 4 pF)</td> </tr> <tr> <td>2.2 ns</td> <td>(@ Csource 5 to 8 pF)</td> </tr> </table> </td> </tr> <tr> <td>Gain Flatness</td> <td>± 0.3 dB</td> </tr> </table>	Lower Cut-Off Frequency	DC	Upper Cut-Off Frequency (-3 dB)	<table border="0"> <tr> <td>200 MHz</td> <td>(± 10 %, @ Csource 2 to 4 pF)</td> </tr> <tr> <td>170 MHz</td> <td>(± 10 %, @ Csource 5 to 8 pF)</td> </tr> </table>	200 MHz	(± 10 %, @ Csource 2 to 4 pF)	170 MHz	(± 10 %, @ Csource 5 to 8 pF)	Max. Source Capacitance	8 pF (incl. cable, e.g. typical coax cable 1 pF/cm)	Rise / Fall Time (10 % - 90 %)	<table border="0"> <tr> <td>1.9 ns</td> <td>(@ Csource 2 to 4 pF)</td> </tr> <tr> <td>2.2 ns</td> <td>(@ Csource 5 to 8 pF)</td> </tr> </table>	1.9 ns	(@ Csource 2 to 4 pF)	2.2 ns	(@ Csource 5 to 8 pF)	Gain Flatness	± 0.3 dB																																												
Lower Cut-Off Frequency	DC																																																														
Upper Cut-Off Frequency (-3 dB)	<table border="0"> <tr> <td>200 MHz</td> <td>(± 10 %, @ Csource 2 to 4 pF)</td> </tr> <tr> <td>170 MHz</td> <td>(± 10 %, @ Csource 5 to 8 pF)</td> </tr> </table>	200 MHz	(± 10 %, @ Csource 2 to 4 pF)	170 MHz	(± 10 %, @ Csource 5 to 8 pF)																																																										
200 MHz	(± 10 %, @ Csource 2 to 4 pF)																																																														
170 MHz	(± 10 %, @ Csource 5 to 8 pF)																																																														
Max. Source Capacitance	8 pF (incl. cable, e.g. typical coax cable 1 pF/cm)																																																														
Rise / Fall Time (10 % - 90 %)	<table border="0"> <tr> <td>1.9 ns</td> <td>(@ Csource 2 to 4 pF)</td> </tr> <tr> <td>2.2 ns</td> <td>(@ Csource 5 to 8 pF)</td> </tr> </table>	1.9 ns	(@ Csource 2 to 4 pF)	2.2 ns	(@ Csource 5 to 8 pF)																																																										
1.9 ns	(@ Csource 2 to 4 pF)																																																														
2.2 ns	(@ Csource 5 to 8 pF)																																																														
Gain Flatness	± 0.3 dB																																																														
Input	<table border="0"> <tr> <td>Equ. Input Noise Current</td> <td>4.9 pA/√Hz (@ 10 MHz)</td> </tr> <tr> <td>Equ. Input Noise Voltage</td> <td>0.9 nV/√Hz (@ 10 MHz)</td> </tr> <tr> <td>Equ. Integrated Noise</td> <td>1.0 μA peak-peak</td> </tr> <tr> <td>Input Bias Current</td> <td>12 μA typ.</td> </tr> <tr> <td>Input Bias Current Drift</td> <td>3 nA / °C</td> </tr> <tr> <td>Offset Current Compensation</td> <td>± 100 μA adjustable by offset trimpot</td> </tr> <tr> <td>Input Current Range</td> <td>± 60 μA (for linear amplification)</td> </tr> <tr> <td>Input Offset Voltage</td> <td>< 1 mV</td> </tr> <tr> <td>DC Input Impedance</td> <td>56 Ω (virtual) // 5 pF</td> </tr> </table>	Equ. Input Noise Current	4.9 pA/√Hz (@ 10 MHz)	Equ. Input Noise Voltage	0.9 nV/√Hz (@ 10 MHz)	Equ. Integrated Noise	1.0 μA peak-peak	Input Bias Current	12 μA typ.	Input Bias Current Drift	3 nA / °C	Offset Current Compensation	± 100 μA adjustable by offset trimpot	Input Current Range	± 60 μA (for linear amplification)	Input Offset Voltage	< 1 mV	DC Input Impedance	56 Ω (virtual) // 5 pF																																												
Equ. Input Noise Current	4.9 pA/√Hz (@ 10 MHz)																																																														
Equ. Input Noise Voltage	0.9 nV/√Hz (@ 10 MHz)																																																														
Equ. Integrated Noise	1.0 μA peak-peak																																																														
Input Bias Current	12 μA typ.																																																														
Input Bias Current Drift	3 nA / °C																																																														
Offset Current Compensation	± 100 μA adjustable by offset trimpot																																																														
Input Current Range	± 60 μA (for linear amplification)																																																														
Input Offset Voltage	< 1 mV																																																														
DC Input Impedance	56 Ω (virtual) // 5 pF																																																														
Output	<table border="0"> <tr> <td>Output Voltage Range</td> <td>± 1.2 V (@ 50 Ω load) for linear operation and low harmonic distortion</td> </tr> <tr> <td>Max. Output Voltage Range</td> <td>± 1.7 V (@ 50 Ω load)</td> </tr> <tr> <td>Output Impedance</td> <td>50 Ω (terminate with 50 Ω load for best performance)</td> </tr> </table>	Output Voltage Range	± 1.2 V (@ 50 Ω load) for linear operation and low harmonic distortion	Max. Output Voltage Range	± 1.7 V (@ 50 Ω load)	Output Impedance	50 Ω (terminate with 50 Ω load for best performance)																																																								
Output Voltage Range	± 1.2 V (@ 50 Ω load) for linear operation and low harmonic distortion																																																														
Max. Output Voltage Range	± 1.7 V (@ 50 Ω load)																																																														
Output Impedance	50 Ω (terminate with 50 Ω load for best performance)																																																														
Bias Output	<table border="0"> <tr> <td>Bias Output Voltage Range</td> <td>± 12 V, adjustable by bias trimpot</td> </tr> <tr> <td>Bias Output Impedance</td> <td>10 kΩ // 1 μF</td> </tr> </table>	Bias Output Voltage Range	± 12 V, adjustable by bias trimpot	Bias Output Impedance	10 kΩ // 1 μF																																																										
Bias Output Voltage Range	± 12 V, adjustable by bias trimpot																																																														
Bias Output Impedance	10 kΩ // 1 μF																																																														

SOPHISTICATED TOOLS FOR SIGNAL RECOVERY



DE-HCA-200M-20K-C_R4/JM/18MAR2019

Datasheet

HCA-200M-20K-C

High-Speed Current Amplifier

Specifications (continued)

Power Supply	Supply Voltage Supply Current	± 15 V ± 50 mA typ. (depends on operating conditions, recommended power supply capability minimum ± 150 mA)
Case	Weight Material	210 g (0.5 lbs) AlMg4.5Mn, nickel-plated
Temperature Range	Storage Temperature Operating Temperature	$-40 \dots +100$ °C $0 \dots +60$ °C

Absolute Maximum Ratings	Input Voltage Power Supply Voltage	± 5 V ± 22 V
--------------------------	---------------------------------------	-------------------------

Connectors	Input Output Power Supply	BNC BNC LEMO series 1S, 3-pin fixed socket Pin 1: +15V Pin 2: -15V Pin 3: GND
------------	---------------------------------	--

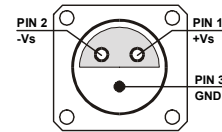

Application Diagrams
Photo Detector Biasing in Photoconductive Mode:
Best choice for high speed applications and optimum signal to noise performance.

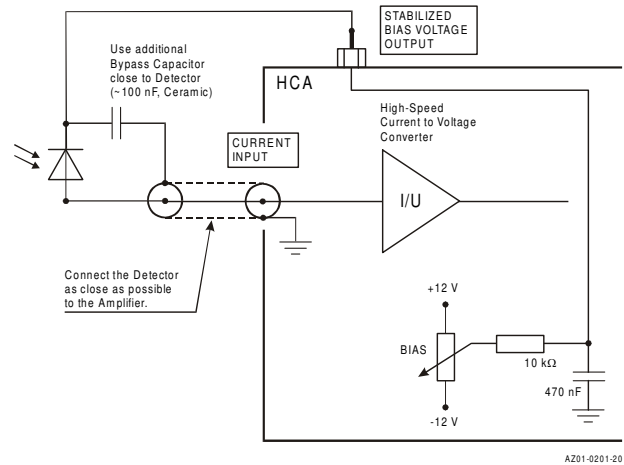

SOPHISTICATED TOOLS FOR SIGNAL RECOVERY

F E M T O

Datasheet

HCA-200M-20K-C

High-Speed Current Amplifier

Typical Performance
Characteristics
(continued)

Pulse Response to Square Wave Input Signal
(with 16 times averaging)

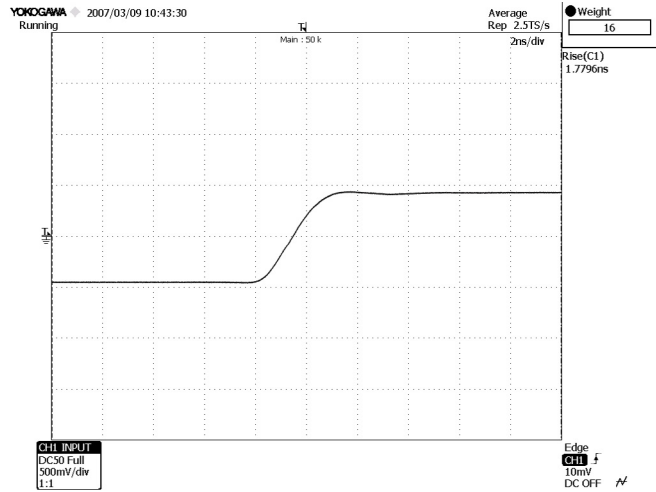

Large Signal Response
output signal for 100 MHz, 50 μ A peak-peak input signal
(with 4 times averaging)

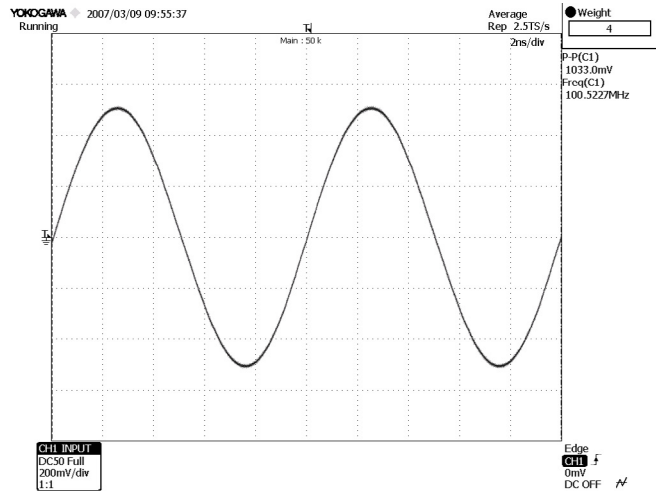

SOPHISTICATED TOOLS FOR SIGNAL RECOVERY



Datasheet

HCA-200M-20K-C

High-Speed Current Amplifier

Typical Performance
Characteristics
(continued)

Small Signal Response
output signal for 1 MHz, 1 μ A peak-peak square wave input signal
(without (top) and with 64 times averaging (bottom))

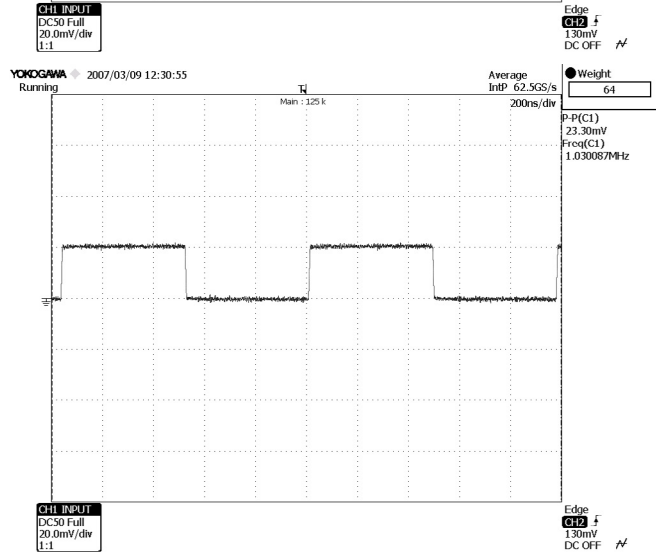
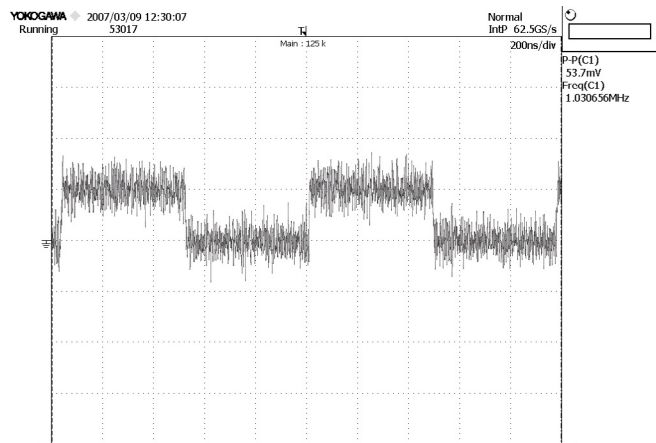

SOPHISTICATED TOOLS FOR SIGNAL RECOVERY



Datasheet

HCA-200M-20K-C

High-Speed Current Amplifier

Dimensions

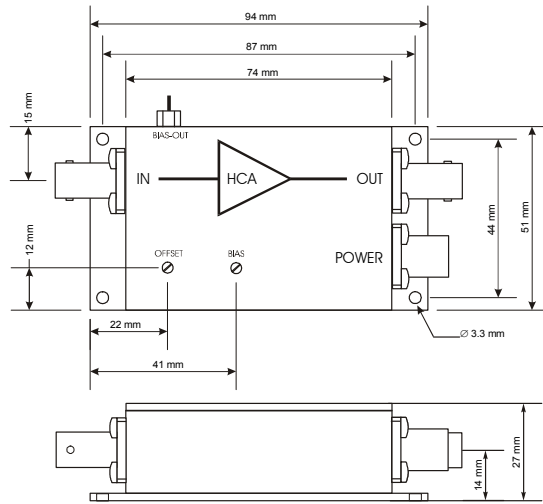

D201-0201-22

Specifications are subject to change without notice. Information provided herein is believed to be accurate and reliable. However, no responsibility is assumed by FEMTO Messtechnik GmbH for its use, nor for any infringement of patents or other rights of third parties which may result from its use. No license is granted by implication or otherwise under any patent or patent rights of FEMTO Messtechnik GmbH. Product names mentioned may also be trademarks used here for identification purposes only.

© by FEMTO Messtechnik GmbH · Printed in Germany

SOPHISTICATED TOOLS FOR SIGNAL RECOVERY

