

Fiber-optic Collimator

To couple light both into and out of an optical fiber, it is essential to have a collimated light beam. With the help of an optical collimator, the divergence of the light beam can be significantly reduced. To meet this demand, LASER COMPONENTS developed its own collimator systems. These solutions are manufactured at the production facility in Olching and are currently available with six focal lengths, three housing assemblies, and various coatings. Emphasis is primarily placed on single-mode fibers, silica fibers with an NA of 0.22, and hollow-core fibers. These collimators can be focused mechanically and are available for SMA and FC connector systems.

Delivered including focusing tool.



Specifications

Applicable with following fiber types	Single mode 9/125, Step-index fibers with NA 0.22, Hollow-core fibers with 750 – 1000 μm core diameter
Wavelength range	VIS/IR and CO ₂
Connector system	SMA, FC wide key, FC small key, FC/APC wide key, FC/APC small key (other connector systems available upon request)
Temperature range	-40 – +140 °C
Power efficiency multimode fiber	>/=85%
Power efficiency CO ₂ fiber	>/=90%

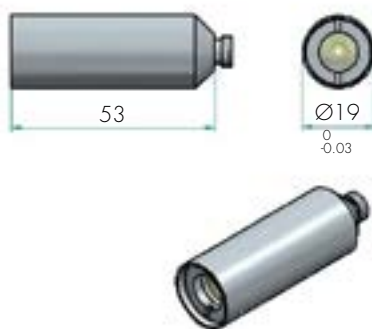

Beam diameter of collimators

Collimator (Vis/IR)

Theoretical beam diameter at collimator exit for fibers with NA 0.22 (fiber-core overlap)	Wavelength	Dimension	Lens
2.8 mm	350 nm – 700 nm 650 nm – 1050 nm 1050 nm – 1600 nm	Ø 11.5 mm x 17.5 mm	f = 6.2 mm
4.9 mm	350 nm – 700 nm 650 nm – 1050 nm 1050 nm – 1600 nm	Ø 11.5 mm x 17.5 mm	f = 11 mm
6.7 mm	400 nm – 700 nm 633 nm – 1064 nm	Ø 19.0 mm x 28.0 mm	f = 15 mm
9.0 mm	400 nm – 700 nm 633 nm – 1064 nm	Ø 19.0 mm x 28.0 mm	f = 20 mm

CO₂ collimator

Beam diameter at exit	Wavelength	Dimension	Lens
4.0 mm	10.6 µm	Ø 19.0 mm x 53.0 mm	f = 25.4 mm
5.5 mm	10.6 µm	Ø 19.0 mm x 53.0 mm	f = 38.1 mm

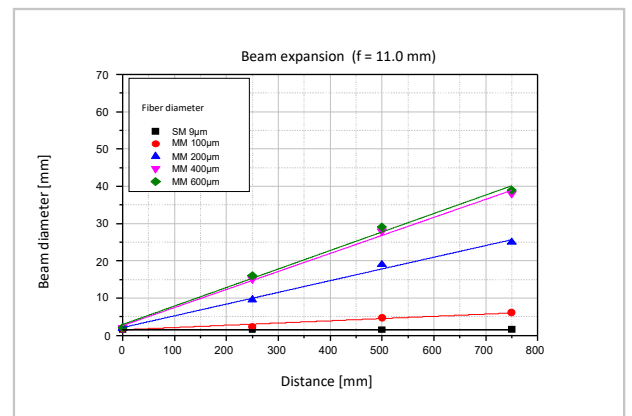
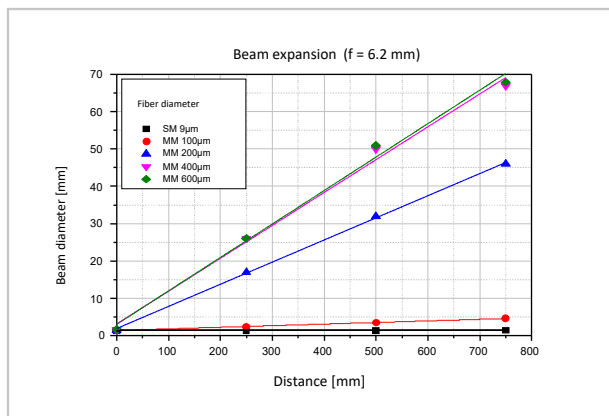

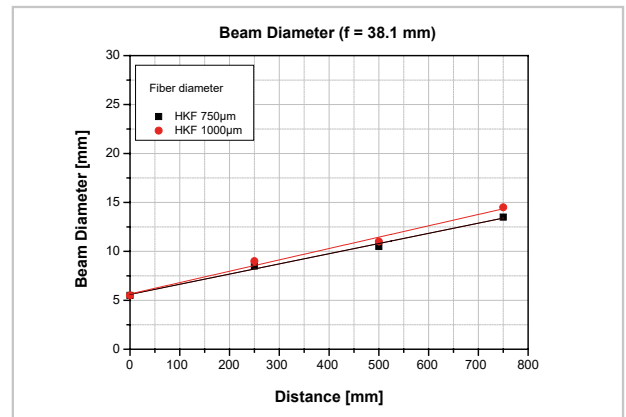
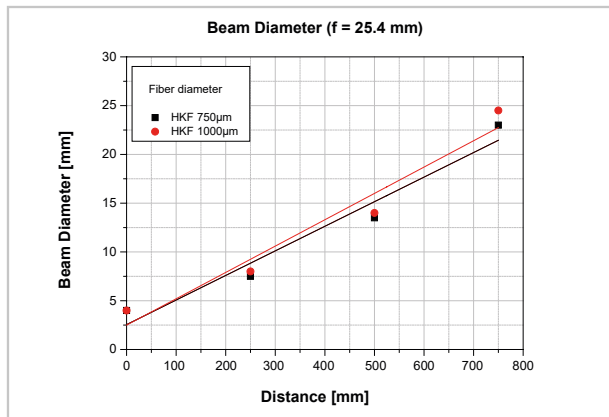
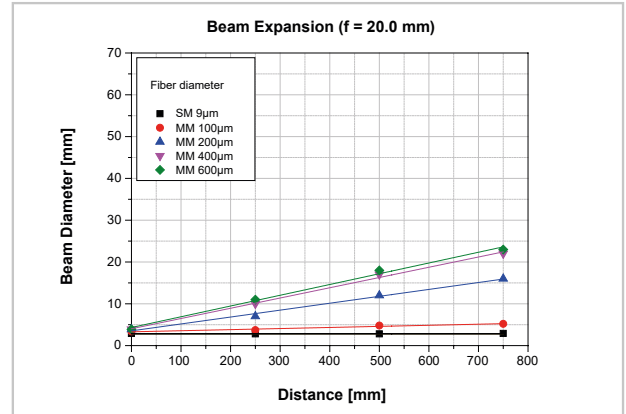
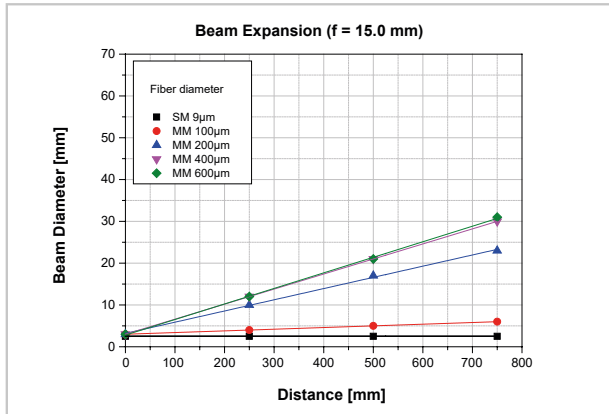

f = (focus length), SM (single-mode), MM (multi-mode), NA (numerical aperture)

Beam profile from a single-mode fiber

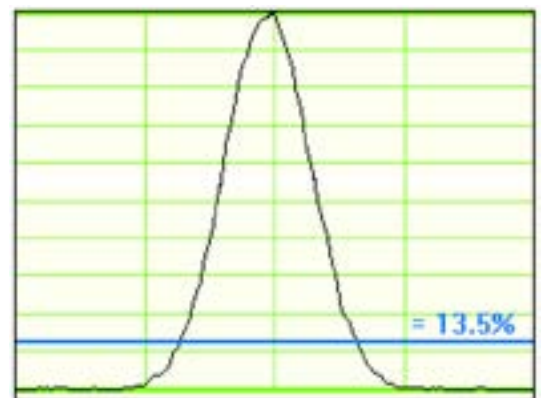
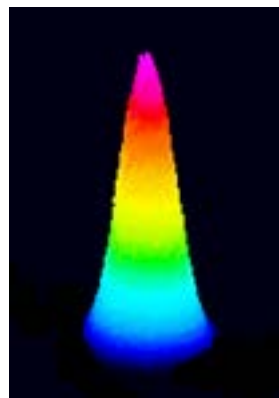
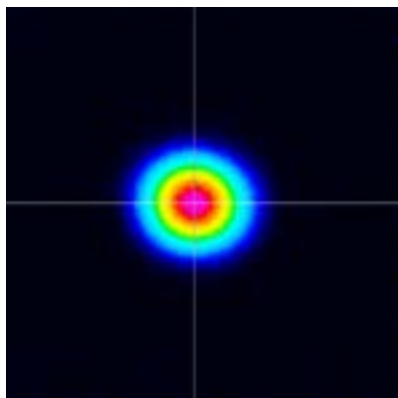

Collimated beam at collimator exit by using an SM fiber with a core diameter of 9 µm.

Beam diameter: 2.5 mm at $1/e^2$ (achieved with a focal length of 6.2 mm)