

**AlGaInP Visible Laser Diode**

**ADL-65075SR**

DATE : 2005/10/18 Ver 1.0

★  $\phi 3.3\text{mm}$  Mini Package!  
7mW Reliable Operation

• **Features**

1. Smallest package
2. Low operating current
3. Higher power

• **Applications**

1. Super slim DVD/Combo OPU
2. Mini size optical modules
3. Laser sensor

• **Absolute maximum ratings**

Parameter	Symbol	Condition	Rating	Unit
Light output power	$P_O$	CW	10	mW
Reverse voltage (LD)	$V_{RL}$	-	2	V
Reverse voltage (PD)	$V_{RD}$	-	30	V
Forward current (PD)	$I_{FD}$	-	10	mA
Case temperature	$T_C$	-	-10~+70	°C
Storage temperature	$T_S$	-	-40~+85	°C

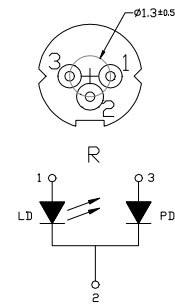
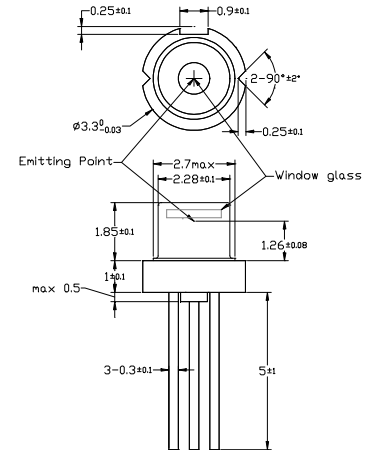

• **Electrical and optical characteristics ( $T_c=25^\circ\text{C}$ )**

Parameter	Symbol	Min.	Typ.	Max.	Unit	Conditions
Peak wavelength	$\lambda$	645	655	660	nm	$P_o=7\text{mW}$
Threshold current	$I_{th}$	-	20	25	mA	
Operating current	$I_{op}$	-	25	35	mA	$P_o=7\text{mW}$
Operating voltage	$V_{op}$	-	2.2	2.5	V	$P_o=7\text{mW}$
Differential efficiency	$\eta$	0.7	0.9	1.2	mW/mA	$P_o=3\text{-}5\text{mW}$
Monitor current	$I_m$	0.1	0.2	0.3	mA	$P_o=7\text{mW}$ , $V_{RD}=0\text{V}$
Parallel divergence angle	$\theta_{  }$	6	9	12	deg	$P_o=7\text{mW}$
Perpendicular divergence angle	$\theta_{\perp}$	25	28	32	deg	
Parallel FFP deviation angle	$\Delta\theta_{  }$	-2	0	+2	deg	
Perpendicular FFP deviation angle	$\Delta\theta_{\perp}$	-2	0	+2	deg	
Emission point accuracy	$\Delta x \Delta y \Delta z$	-80	0	+80	um	

• **Precautions**

- Do not operate the device above maximum ratings. Doing so may cause unexpected and permanent damage to the device.
- Take precautions to avoid electrostatic discharge and/or momentary power spikes. A change in the characteristics of the laser or premature failure may result.
- Proper heat sinking of the device assures stability and lifetime. Always ensure that maximum operating temperatures are not exceeded.
- Observing visible or invisible laser beams with the human eye directly, or indirectly, can cause permanent damage. Use a camera to observe the laser.
- No laser should be used in any application or situation where life or property is at risk in event of device failure.
- Specifications are subject to change without notice. Ensure that you have the latest specification by contacting us prior to purchase or use of the product

\* For reference only. Contents above are subject to change without notice.

PRELIMINARY

**AlGaInP Visible Laser Diode**

**ADL-65075SR**

DATE : 2005/10/18 Ver 1.0

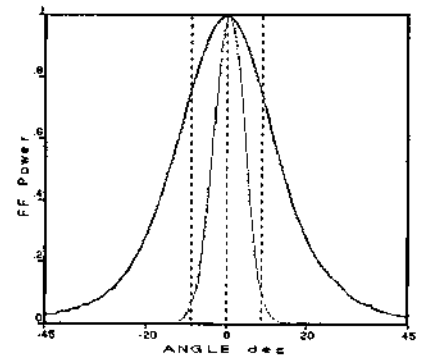
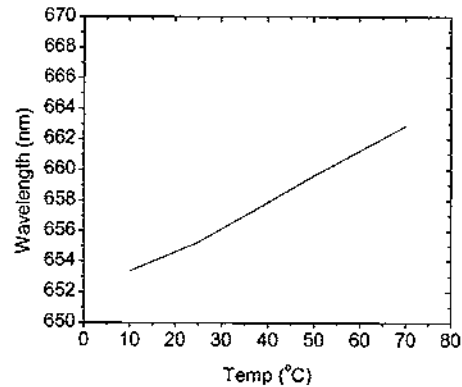
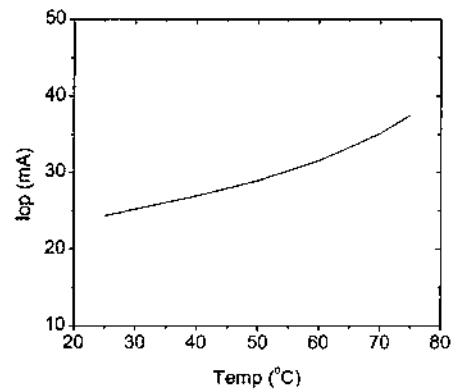
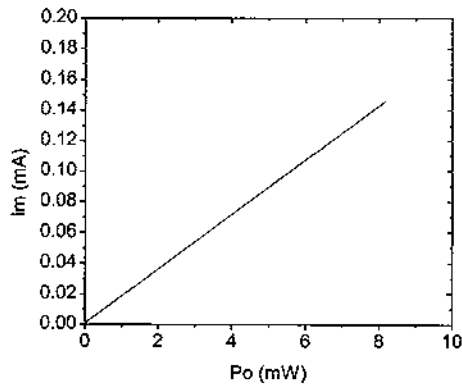
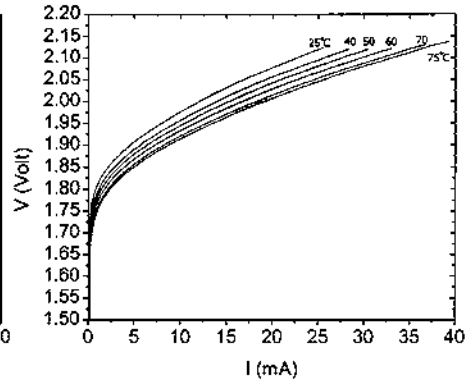
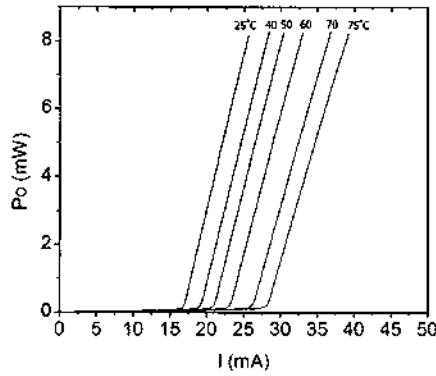

\* For reference only. Contents above are subject to change without notice.

10/14 / V2 / HW / arima/655nm/adl65075sr