

FLEXPOINT® Machine Vision Lasers MV12 Series

The FLEXPOINT® MV12 lasers produce a crisp line with uniform intensity and were specifically developed for industrial applications. Thanks to their M12x1 external thread and their housings made of stainless steel, these lasers are easy to integrate.

A wide range of power levels, wavelengths and fan angles is available

Features

- Uniform line intensity
- Focusable
- Industrial grade housing
- 4.5 – 30 VDC supply voltage
- Universal tool for industrial inspection and 3D triangulation

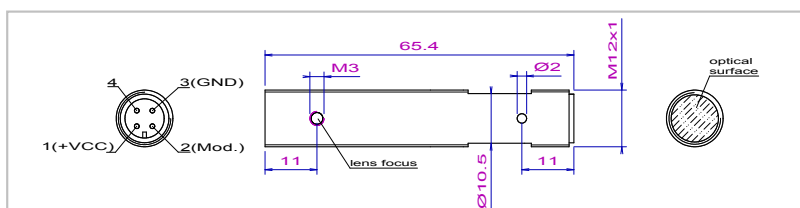

Specifications

Fan angle	5, 10, 15, 20, 30, 45, 60, 75, 90 deg.
Line uniformity	±20% (optional ±10 %) related to average power, within 80% of the line
Line straightness	±0.1 % (±0.05 % as option)
Optic options	Standard DL (for smaller thinner line) TS (for enhanced depth of focus) large field of view compensation: less intensity in the center of the line compared to the edges
Wavelength	405 nm, 450 nm, 520 nm, 635 nm – 640 nm, 650 nm – 660 nm, 685 nm, 785 nm, 850 nm
Wavelength stability	≤ 0.25 nm/°C
Output power	<1 mW – 100 mW (depends on wavelength)

Specifications

Output power stability	< 5% (after warm up at 25 °C)
Modulation (option)	digital, 0 – 10 kHz (active low, higher frequency on request)
Power adjustment (option)	by control wire 0 – 5 V (active low)
Bore sighting	≤10 mrad (≤ 3 mrad as option)
Pointing stability	10 µrad/°C
Focus	adjustable by Allen key
Operating voltage	4.5 – 30 VDC (reverse voltage protection), 10 – 30 VDC for 405/450/520 nm
Current consumption	< 200 mA @ 5 VDC
Operating temperature (housing)	-20 to +50 °C (depends on wavelength)
Storage temperature	-20 to +60 °C
Housing material	stainless steel, potential free
Housing dimensions	l ≤ 67 mm, Ø M12x1
Connector	M12 sensor connector (2 m cable as option) pin definition: 1. + VCC 2. modulation (option) 3. GND 4. adjustable power (option)

Ordering Code FLEXPOINT® MV12 Series

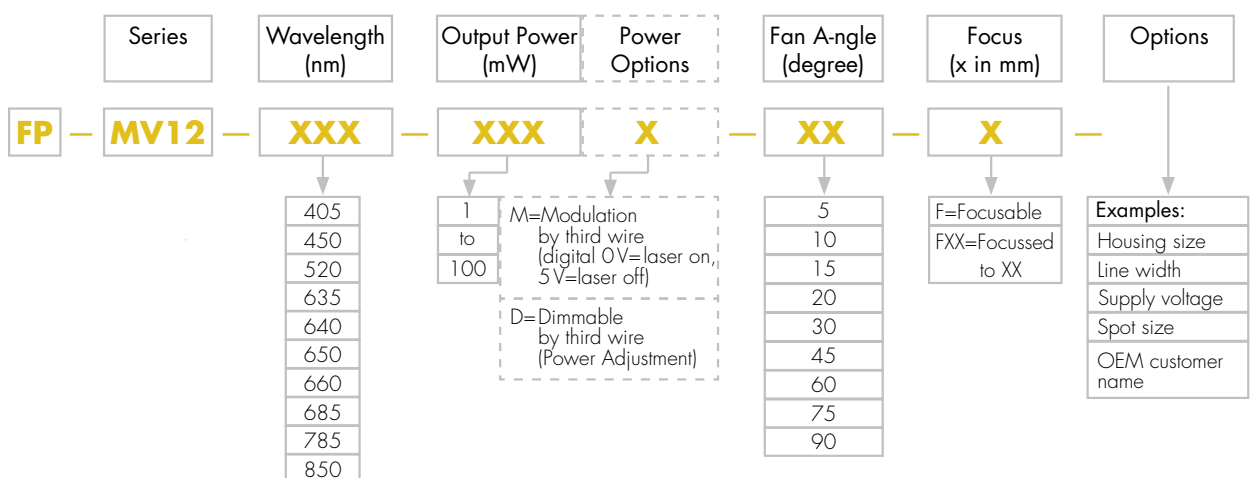

Standard Lasers

FP-MV12-660-100-30-F	(660 nm, 100 mW, 30° fan angle, focusable)
FP-MV12-660-50-90-F	(660 nm, 50 mW, 90° fan angle, focusable)
FP-MV12-660-50-45-F	(660 nm, 50 mW, 45° fan angle, focusable)
FP-MV12-660-30-20-F	(660 nm, 30 mW, 20° fan angle, focusable)
FP-MV12-660-10-15-F	(660 nm, 10 mW, 15° fan angle, focusable)
FP-MV12-785-50-20-F	(785 nm, 50 mW, 20° fan angle, focusable)

Any other configuration (wavelength / output power / fan angle) available.

The following figures show the typical minimum line width (at $1/e^2$) and the typical focal depth that can be achieved with FLEXPOINT® MV12 lasers at different distances. The depth of focus is defined as the range in which the minimum line width increases by factor $\sqrt{2}$. Line lasers of the MV12 series can be focused between 50 mm and infinity. Alternatively it is possible to set the working distance to a fixed value during production.

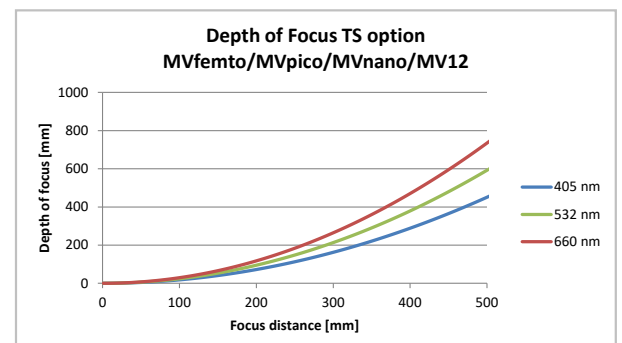
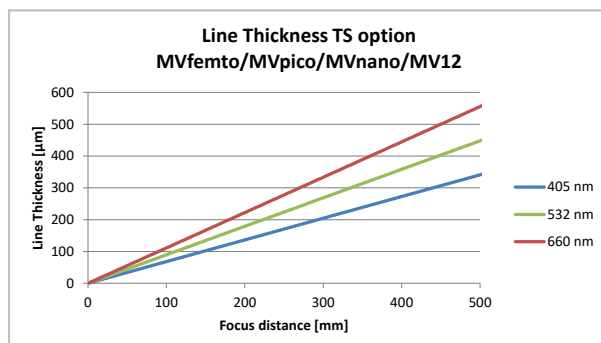
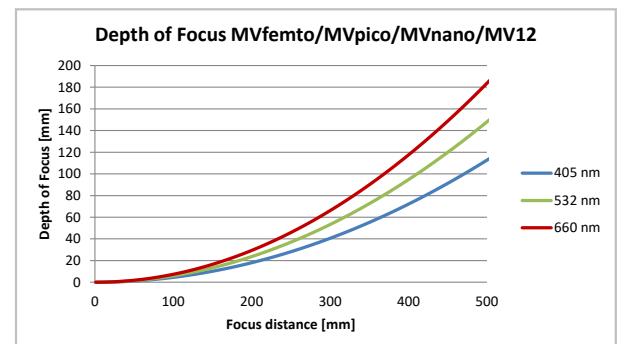
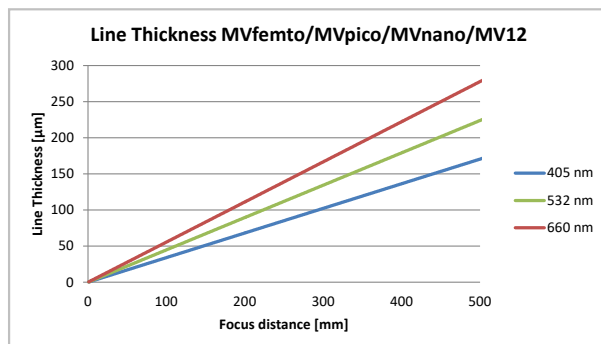

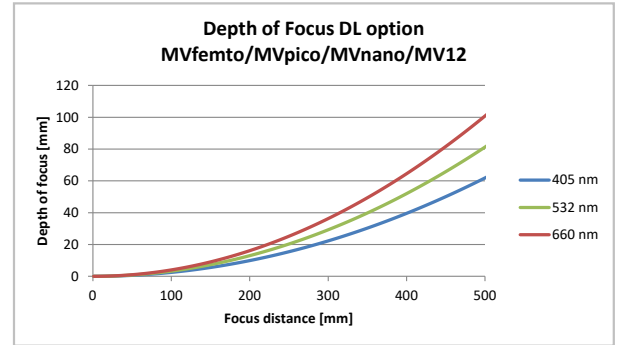
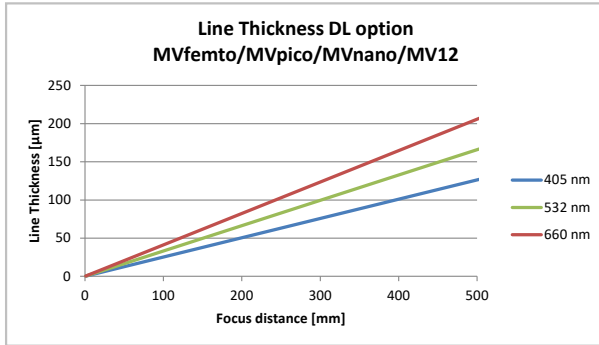

The diagram below shows the typical dimming behavior (option 'D'). In the off-condition a faint emission of about 0.5% of the full laser power may occur in some cases.

