

LCU85A061Ap

LCU85xx SERIES LASER DIODE

■ Features

1. Small perpendicular divergence angle
2. Lateral single mode lasing
3. Standard optical power output : 100mW (CW)
4. TO-56 (ϕ 5.6mm) Packaged, with Pb-free window cap.
5. Built-in Photo Diode for monitoring laser diode.

■ Applications

1. Motion sensor
2. 3D depth sensor
3. Illumination
4. Industry
5. Medical application

■ External dimensions(Unit : mm)

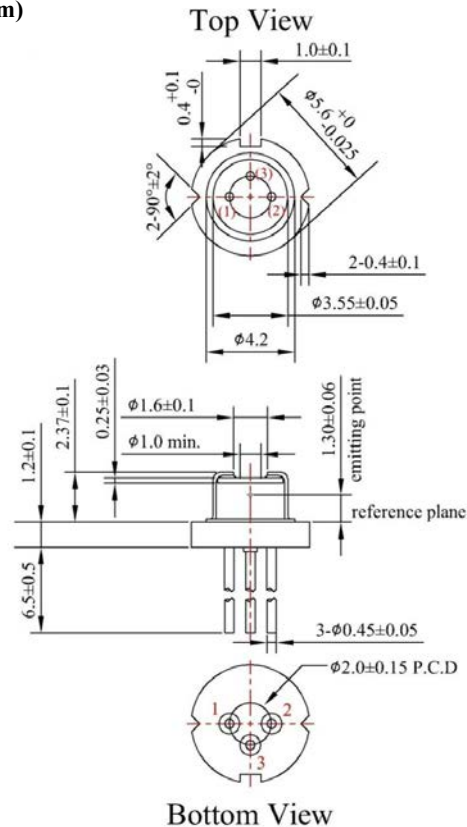
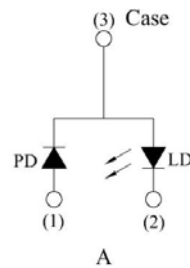

Ver.B

LCU85A061Ap

LCU85xx SERIES LASER DIODE

Absolute Maximum Ratings(Tc=25°C)

Parameter	Symbol	Rating	Unit
Optical Output	Po	100	mW
Reverse Voltage	Vr	2	V
Operating Temperature (Case)	Top	-10~+60	°C
Storage Temperature	Tstg	-40~+85	°C

Electrical and Optical Characteristics(Tc=25°C)

Parameter	Symbol	Condition	Min.	Typ.	Max.	Unit
Threshold Current	Ith	Po=100mW	-	15	25	mA
Operating Current	Iop	Po=100mW	-	125	140	mA
Operating Voltage	Vop	Po=100mW	-	2.3	2.6	V
Slope Efficiency	η	Po=25-75mW	-	0.90	-	mW/mA
Monitor Current	Im	Po=100mW	0.1	0.25	1.0	mA
Beam Divergence (FWHM)	Parallel	$\theta_{//}$	-	10	15	deg.
	Perpendicular	θ_{\perp}	-	18	23	deg.
Lasing Wavelength	λ	Po=100mW	840	850	860	nm

© $\theta_{//}$ and θ_{\perp} are defined as the angle within which the intensity is 50% of the peak value.

Quality Notice

This device is still under product development.

Typical characteristic curves

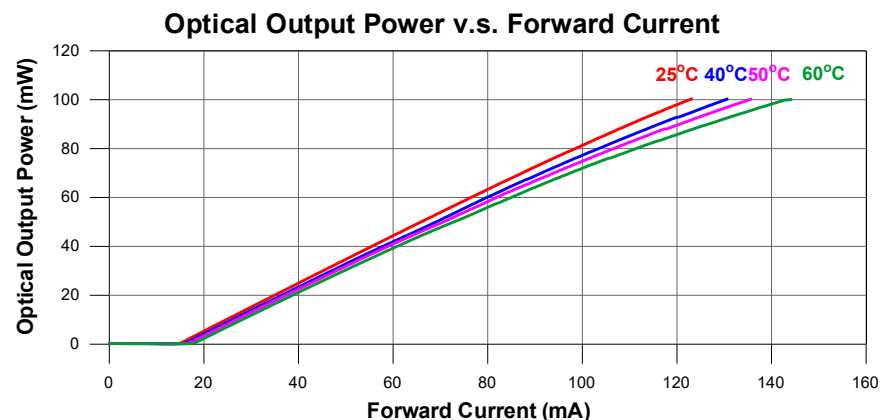

Ver.B

LCU85A061Ap

LCU85xx SERIES LASER DIODE

Forward Voltage v.s. Forward Current

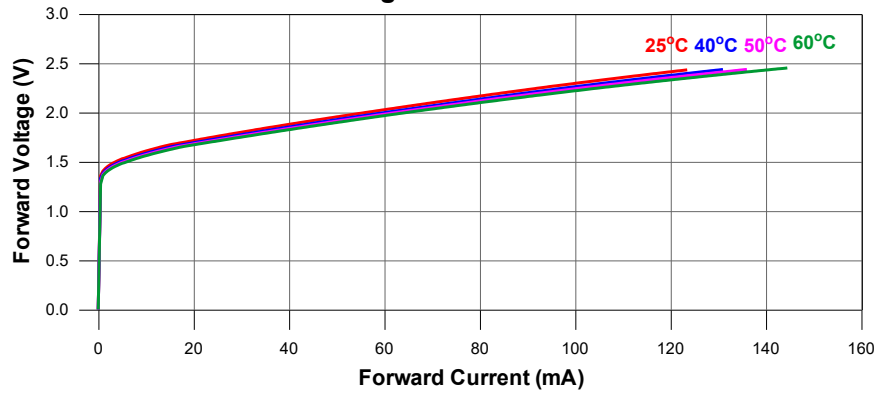

Peak Wavelength v.s. Case Temperature

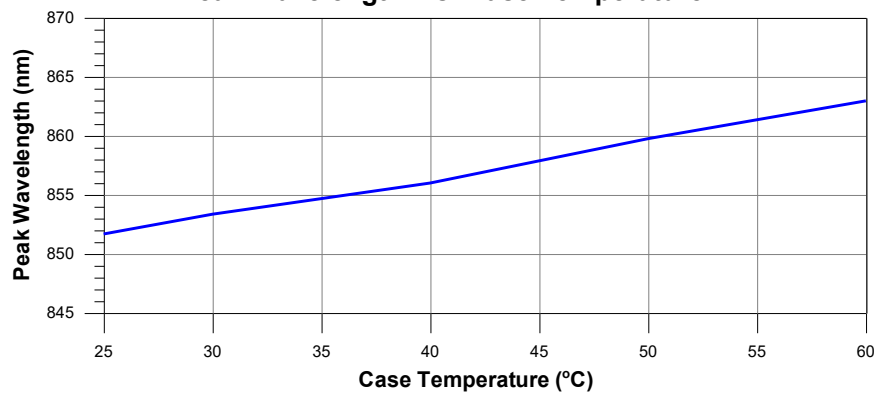

Far-Field Pattern

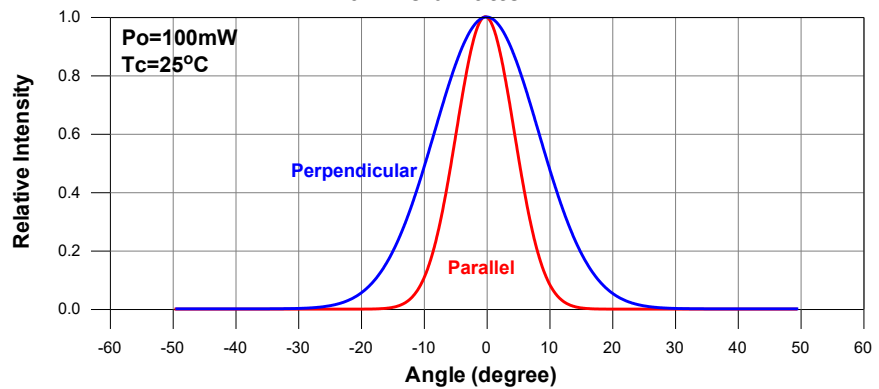

Ver.B

LCU85A061Ap

LCU85xx SERIES LASER DIODE

Monitor Current v.s. Optical Output Power

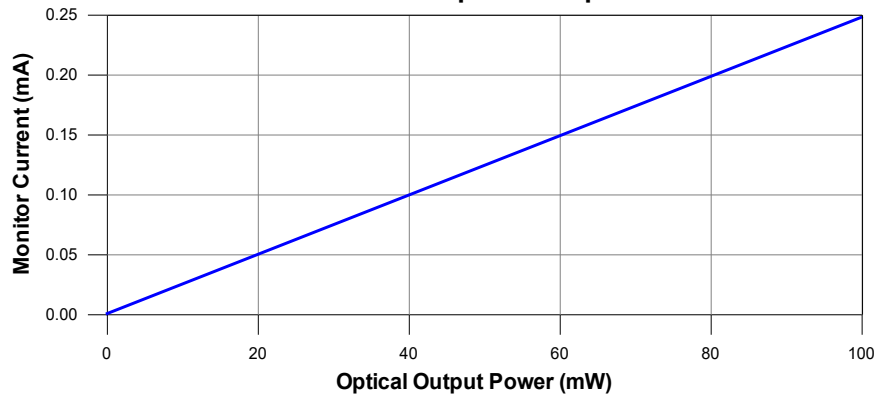

Slope Efficiency v.s. Case Temperature

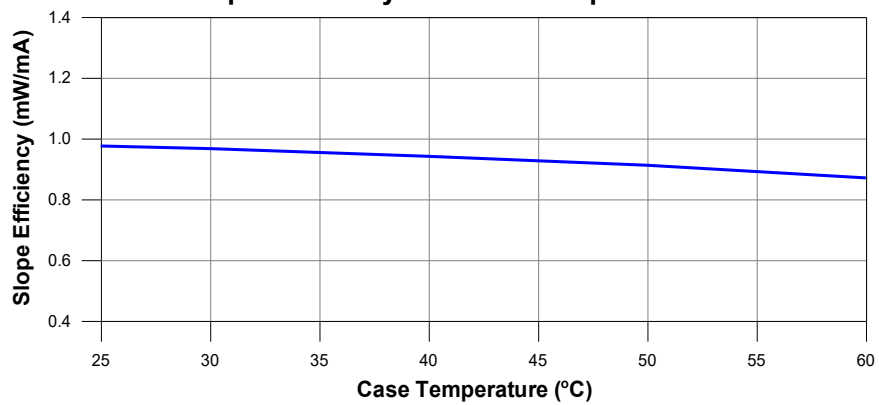

Threshold Current v.s. Case Temperature

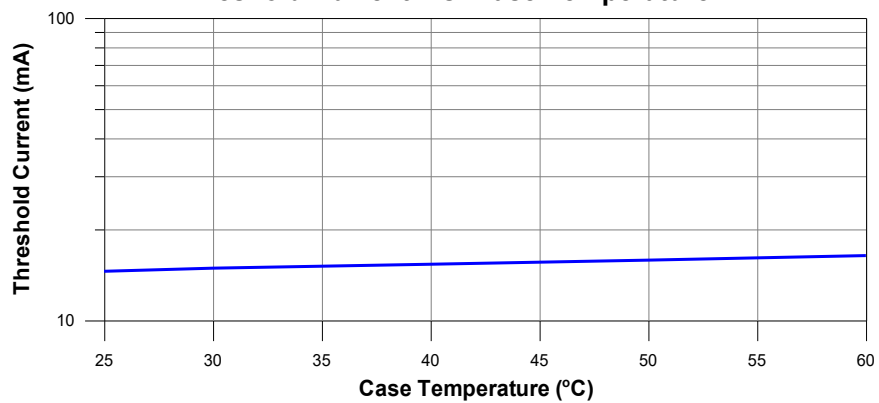

Ver.B

SPECIFICATIONS ARE SUBJECT TO CHANGE WITHOUT NOTICE.