

AlGaInP | Visible Laser Diode

ADL-63301TL

6-2D-LD63-061 Rev.03

635nm 30mW 40°C Reliable Operation

Features

- High visibility
- High ESD Level

Applications

- Industrial laser markers
- Survey and engineering instruments
- High visibility LD display
- Lighting show

Absolute maximum ratings

Parameter	Symbol	Condition	Rating	Unit
Light output power	P_o	CW	35	mW
Reverse voltage (LD)	V_{RL}	-	2	V
Reverse voltage (PD)	V_{RD}	-	30	V
Forward current (PD)	I_{FD}	-	10	mA
Case temperature	T_c	-	-10~+40	°C
Storage temperature	T_s	-	-40~+85	°C

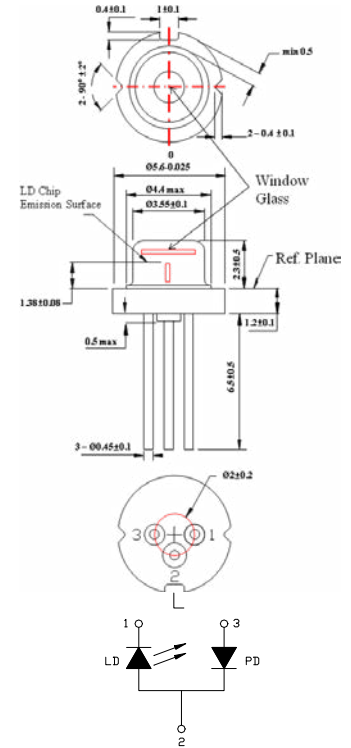

Electrical and optical characteristics ($T_c=25^\circ\text{C}$)

Parameter	Symbol	Min.	Typ.	Max.	Unit	Conditions
Peak wavelength	λ	630	640	645	nm	$P_o=30\text{ mW}$
Threshold current	I_{th}	-	50	70	mA	
Operating current	I_{op}	-	100	120	mA	$P_o=30\text{ mW}$
Operating voltage	V_{op}	-	2.3	2.7	V	$P_o=30\text{ mW}$
Differential efficiency	η	0.3	0.6	1.2	mW/mA	$P_o=25\text{-}30\text{mW}$
Monitor current	I_m	0.1	0.25	0.5	mA	$P_o=30\text{mW}, V_{RD}=5\text{V}$
Parallel divergence angle	$\theta_{//}$	5	8	12	deg.	$P_o=30\text{ mW}$
Perpendicular divergence angle	θ_{\perp}	25	33	38	deg.	
Parallel FFP deviation angle	$\Delta\theta_{//}$	-3	0	+3	deg.	
Perpendicular FFP deviation angle	$\Delta\theta_{\perp}$	-3	0	+3	deg.	
Emission point accuracy	$\Delta x\Delta y\Delta z$	-80	0	+80	um	

• Precautions

- Do not operate the device above maximum ratings. Doing so may cause unexpected and permanent damage to the device.
- Take precautions to avoid electrostatic discharge and/or momentary power spikes. A change in the characteristics of the laser or premature failure may result.
- Proper heat sinking of the device assures stability and lifetime. Always ensure that maximum operating temperatures are not exceeded.
- Observing visible or invisible laser beams with the human eye directly, or indirectly, can cause permanent damage. Use a camera to observe the laser.
- No laser device should be used in any application or situation where life or property is at risk in event of device failure.
- Specifications are subject to change without notice. Ensure that you have the latest specification by contacting us prior to purchase or use of the product.

For reference only. Contents above are subject to change without notice.

AlGaInP | Visible Laser Diode

ADL-63301TL

6-2D-LD63-061 Rev.03

635nm 30mW 40°C Reliable Operation

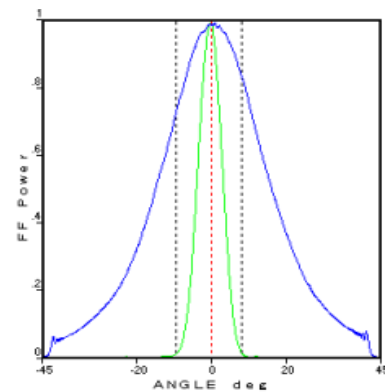
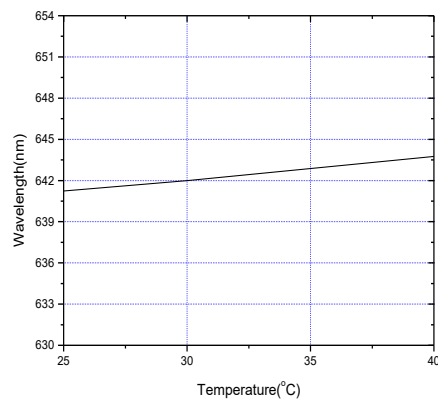
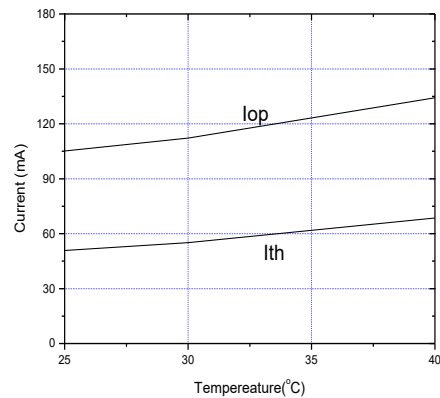
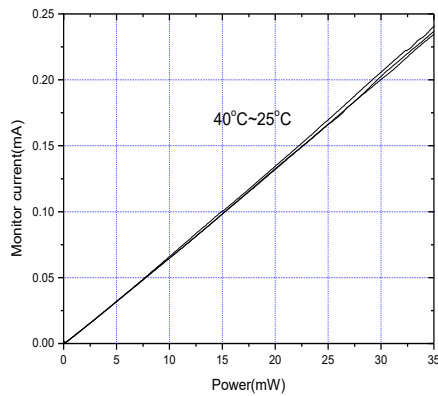
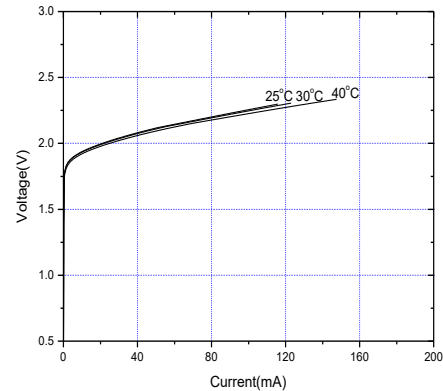
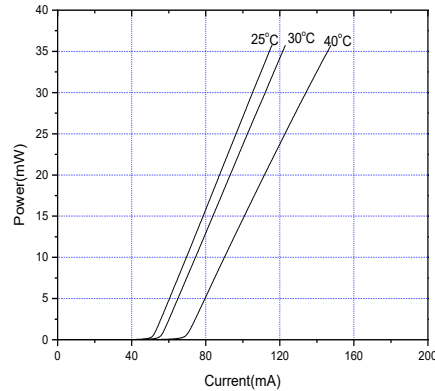

For reference only. Contents above are subject to change without notice.