

ADL-65053TL-2

AlGaInP Visible Laser Diode

★650nm 5mW 70°C Reliable Operation

•Features

1. High temperature operation
2. FFP single lateral mode
3. High reliability
4. Excellent far field pattern.

•Applications

1. Laser pointers
2. Industrial laser markers / measuring instruments
3. Bar code readers

•Absolute maximum ratings

Parameter	Symbol	Condition	Rating	Unit
Light output power	P_O	CW	7	mW
Reverse voltage (LD)	V_{RL}	-	2	V
Reverse voltage (PD)	V_{RD}	-	30	V
Forward current (PD)	I_{FD}	-	10	mA
Case temperature	T_C	-	-10~+70	°C
Storage temperature	T_S	-	-40~+85	°C

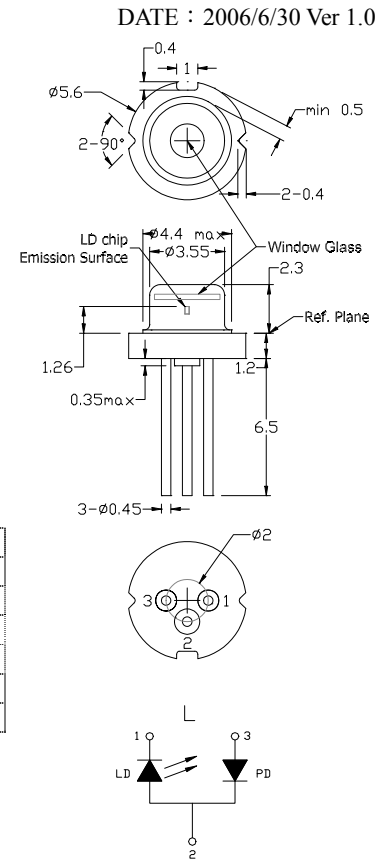

•Electrical and optical characteristics ($T_c=25^\circ\text{C}$)

Parameter	Symbol	Min.	Typ.	Max.	Unit	Conditions
Peak wavelength	λ	645	655	660	nm	$P_o=5\text{mW}$
Threshold current	I_{th}	-	20	25	mA	
Operating current	I_{op}	-	25	35	mA	$P_o=5\text{mW}$
Operating voltage	V_{op}	-	2.15	2.5	V	$P_o=5\text{mW}$
Differential efficiency	η	0.5	0.75	1.0	mW/mA	$P_o=3\text{--}5\text{mW}$
Monitor current	I_m	0.05	0.1	0.3	mA	$P_o=5\text{mW}, V_{RD}=5\text{V}$
Parallel divergence angle	$\theta_{ }$	6	8	10	deg	$P_o=5\text{mW}$
Perpendicular divergence angle	θ_{\perp}	24	28	35	deg	
Parallel FFP deviation angle	$\Delta\theta_{ }$	-3	0	+3	deg	
Perpendicular FFP deviation angle	$\Delta\theta_{\perp}$	-3	0	+3	deg	
Emission point accuracy	$\Delta x \Delta y \Delta z$	-80	0	+80	um	

•Precautions

- Do not operate the device above maximum ratings. Doing so may cause unexpected and permanent damage to the device.
- Take precautions to avoid electrostatic discharge and/or momentary power spikes. A change in the characteristics of the laser or premature failure may result.
- Proper heat sinking of the device assures stability and lifetime. Always ensure that maximum operating temperatures are not exceeded.
- Observing visible or invisible laser beams with the human eye directly, or indirectly, can cause permanent damage. Use a camera to observe the laser.
- No laser device should be used in any application or situation where life or property is at risk in event of device failure.
- Specifications are subject to change without notice. Ensure that you have the latest specification by contacting us prior to purchase or use of the product.

* For reference only. Contents above are subject to change without notice.

AlGaInP Visible Laser Diode

ADL-65053TL-2

DATE : 2006/6/30 Ver 1.0

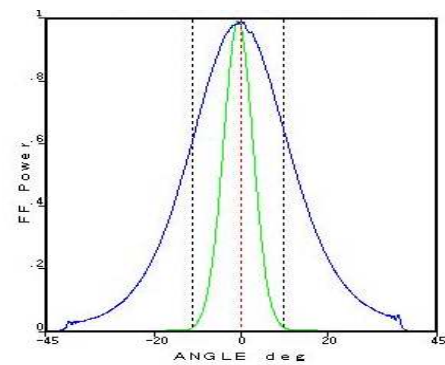
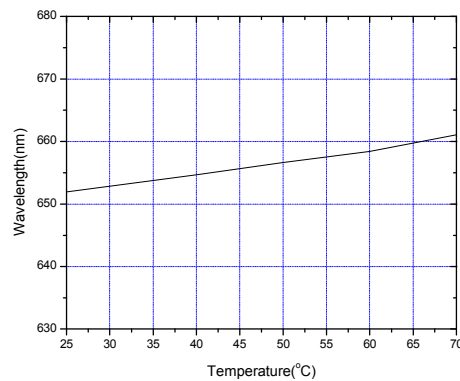
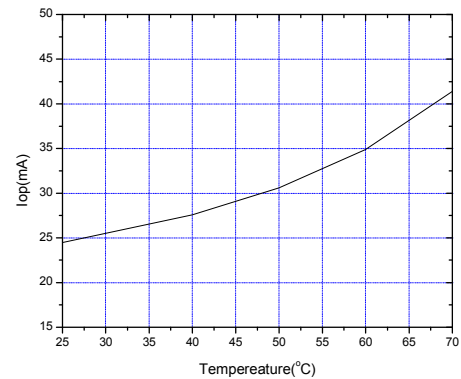
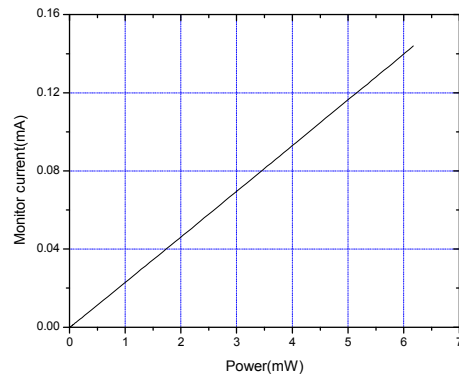
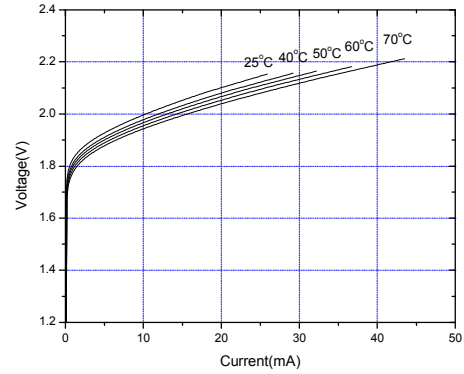
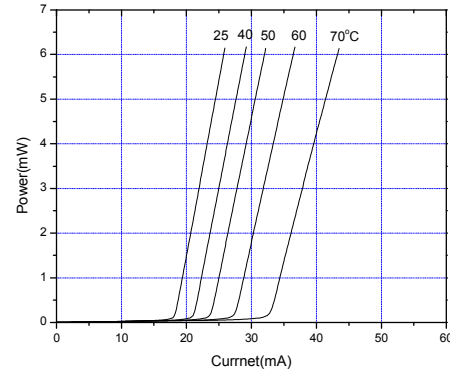

** For reference only. Contents above are subject to change without notice.*