

## LCU650570Ap

LCU65xx SERIES 5630 LASER DIODE

### ■ Features

1. Peak wavelength at 25°C : 650 nm (typical)
2. Standard optical power output : 5mW (CW)
3. 5630 Packaged
4. High temperature operation
5. single mode lasing

### ■ Applications

1. Laser Module
2. Laser Pointer
3. Medical application

### ■ External dimensions(Unit : mm) 5.60×3.00×0.80

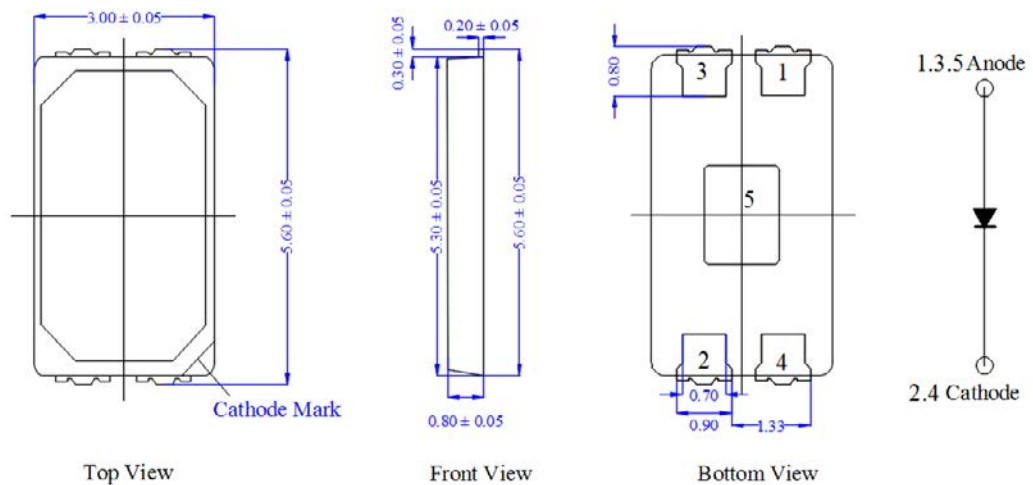

### Notes:

1. Drawings are not to scale
2. All dimensions are all in millimeter
3. All dimensions without tolerance are for reference only

Ver.B

## LCU650570Ap

LCU65xx SERIES 5630 LASER DIODE

### Soldering Conditions(Reference Outline)

Soldering pad pattern

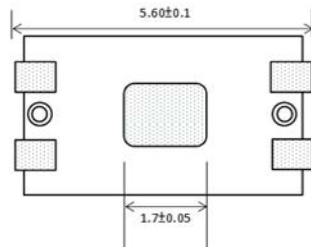

Metal solder stencil aperture

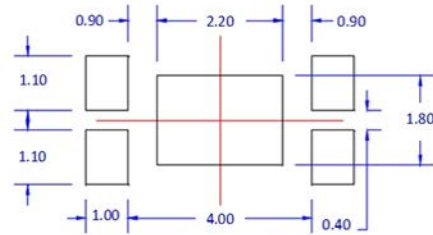

NOTE : All dimensions in mm tolerance is +/- 0.1mm unless otherwise noted.

The drawing above shows the recommended solder pad layout on Printed Circuit Board (PCB).

### ■ Emission direction

Laser beam

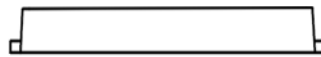

### ■ Absolute Maximum Ratings(Tc=25°C)

Parameter	Symbol	Rating	Unit
Optical Output	Po	5	mW
Reverse Voltage	Vr	2	V
Operating Temperature ( Case )	Top	-10~+70	°C
Storage Temperature	Tstg	-40~+85	°C

Ver.B

## LCU650570Ap

LCU65xx SERIES 5630 LASER DIODE

### ■ Electrical and Optical Characteristics(Tc=25°C)

Parameter	Symbol	Condition	Min.	Typ.	Max.	Unit	
Threshold Current	I <sub>th</sub>	P <sub>o</sub> =5mW	-	12	25	mA	
Operating Current	I <sub>op</sub>	P <sub>o</sub> =5mW	-	17	25	mA	
Operating Voltage	V <sub>op</sub>	P <sub>o</sub> =5mW	-	2.2	2.5	Volts	
Slope Efficiency	η	P <sub>o</sub> =1.5-5mW	0.7	1	-	mW/mA	
Beam Divergence (FWHM)	Parallel	θ <sub>∥</sub>	P <sub>o</sub> =5mW	5	7.5	12	deg.
	Perpendicular	θ <sub>⊥</sub>	P <sub>o</sub> =5mW	30	36	42	deg.
Lasing Wavelength	λ	P <sub>o</sub> =5mW	640	650	660	nm	

© θ<sub>∥</sub> and θ<sub>⊥</sub> are defined as the angle within which the intensity is 50% of the peak value.

### ■ Quality Notice

This device is still under product development.

### ■ Typical characteristic curves

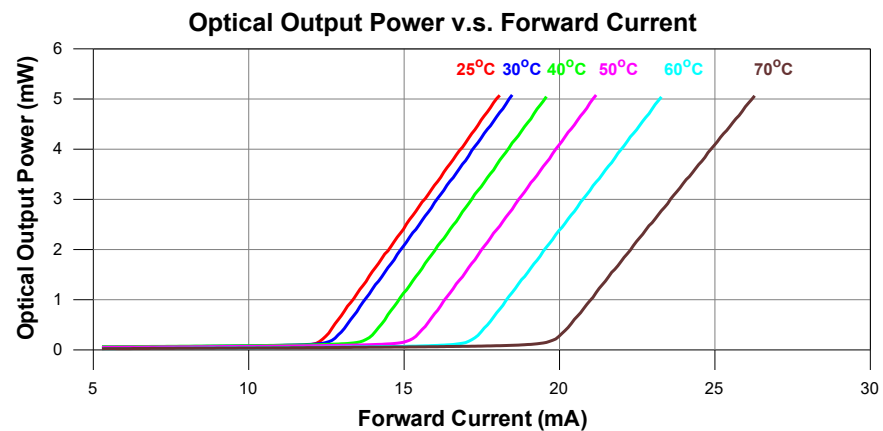

Ver.B

## LCU650570Ap

LCU65xx SERIES 5630 LASER DIODE

### Forward Voltage v.s. Forward Current

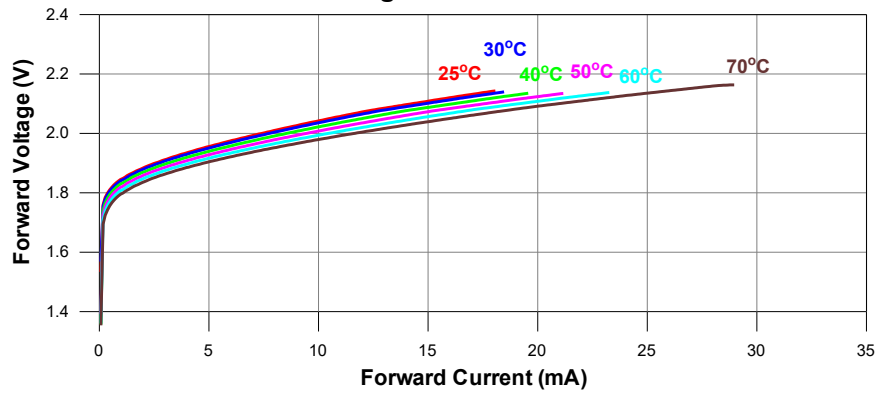

### Peak Wavelength v.s. Case Temperature

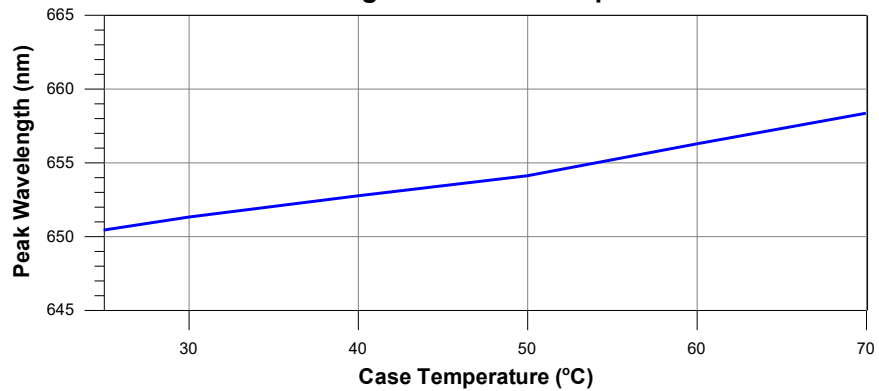

### Far-Field Pattern

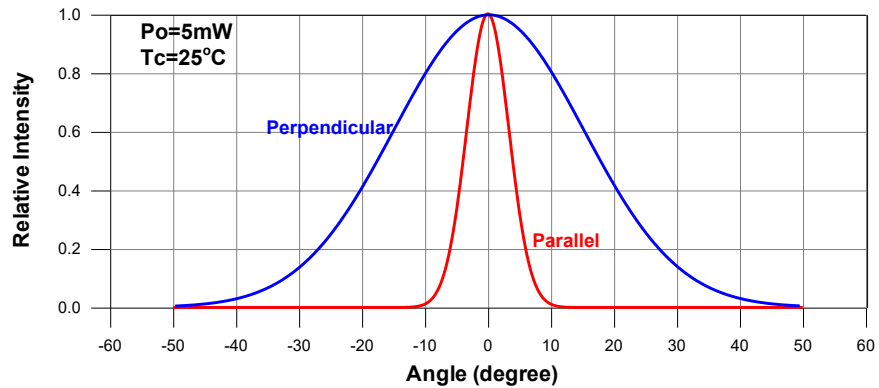

Ver.B

## LCU650570Ap

LCU65xx SERIES 5630 LASER DIODE

Slope Efficiency v.s. Case Temperature

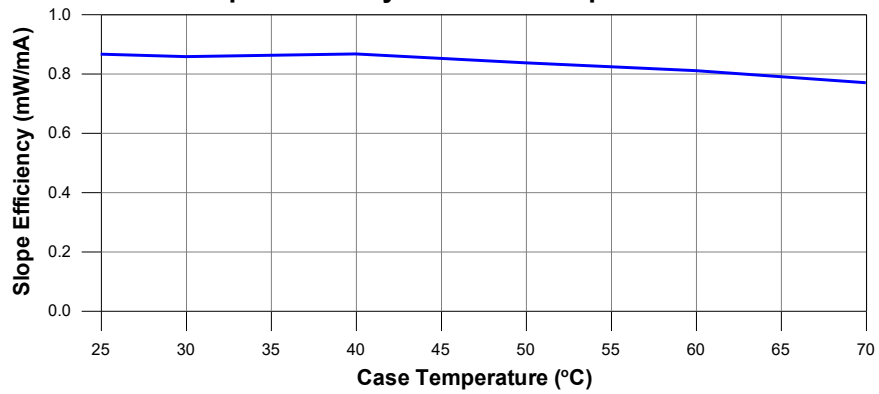

Threshold Current v.s. Case Temperature

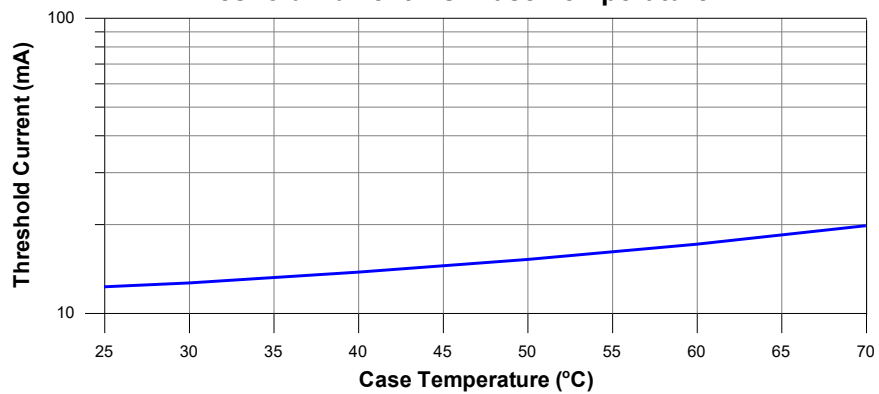

Power v.s. Case Temperature

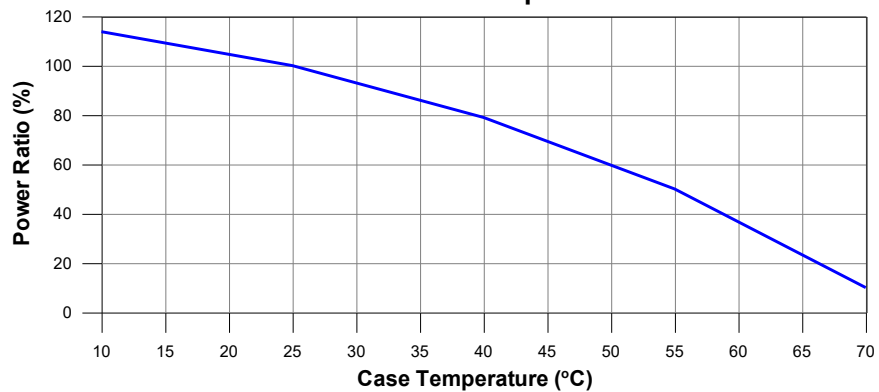

Ver.B

## LCU650570Ap

LCU65xx SERIES 5630 LASER DIODE

### ■ Radiation Pattern in Polar Coordinate System

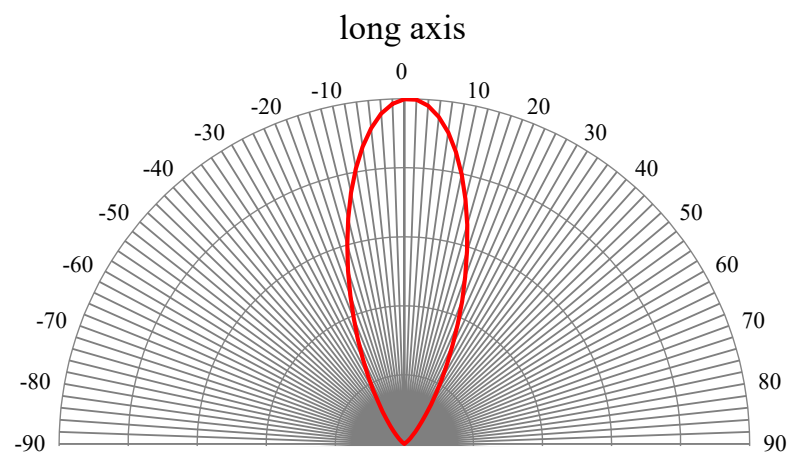
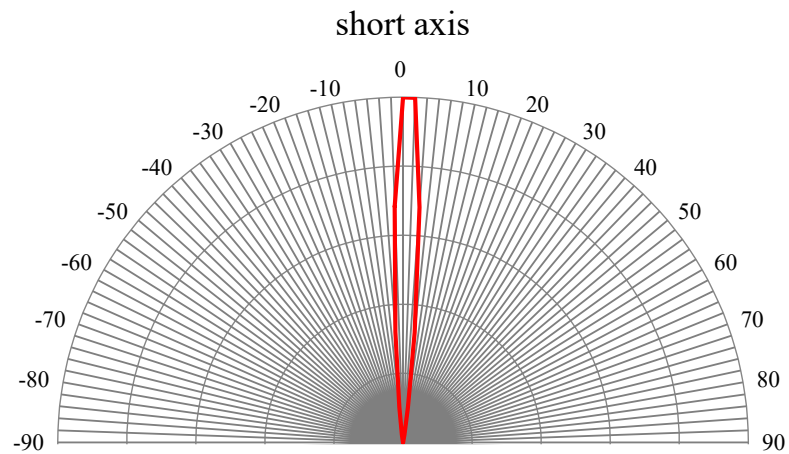

Ver.B

## LCU650570Ap

LCU65xx SERIES 5630 LASER DIODE

### ■ Recommend reflow conditions

Low temperature solder is recommended.

Maximum solder profile should be less than 200°C 1min.

### ■ Packing Information

#### - Embossed Tape Dimension

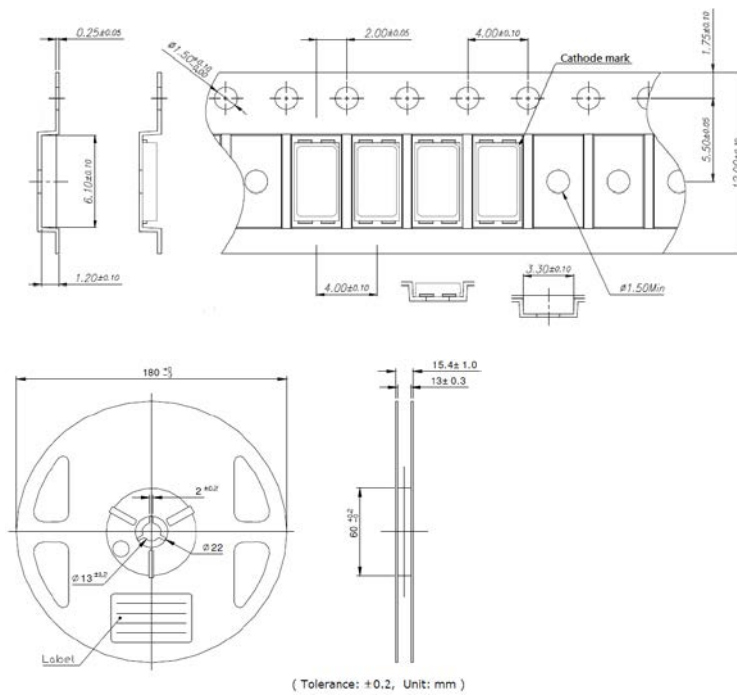

Ver.B