

ADL-65078TU-1

AlGaInP Visible Laser Diode

★650nm 5mW 70 °C Reliable Operation!

•Features

1. Excellent far field pattern
2. Higher power
3. High accuracy

•Applications

1. Laser pointer
2. Laser leveler
3. Bar code scanner

•Absolute maximum ratings

Parameter	Symbol	Condition	Rating	Unit
Light output power	P_O	CW	7	mW
Reverse voltage (LD)	V_{RL}	-	2	V
Reverse voltage (PD)	V_{RD}	-	30	V
Forward current (PD)	I_{FD}	-	10	mA
Case temperature	T_C	-	-20~+70	°C
Storage temperature	T_S	-	-40~+85	°C

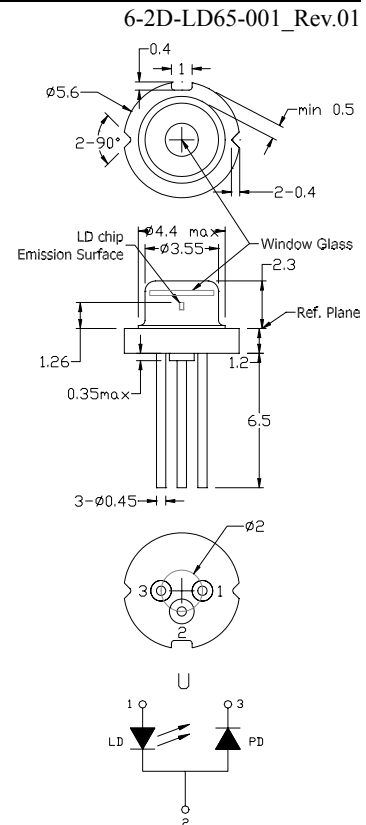

•Electrical and optical characteristics ($T_c=25^\circ\text{C}$)

Parameter	Symbol	Min.	Typ.	Max.	Unit	Conditions
Peak wavelength	λ	645	655	660	nm	$P_o=5\text{mW}$
Threshold current	I_{th}	-	18	30	mA	
Operating current	I_{op}	-	30	42	mA	$P_o=5\text{mW}$
Operating voltage	V_{op}		2.2	2.5	V	$P_o=5\text{mW}$
Differential efficiency	η	0.2	0.45	0.6	mW/mA	$P_o=3-5\text{mW}$
Monitor current	I_m	0.1	0.22	0.4	mA	$P_o=5\text{mW}, V_{RD}=5\text{V}$
Parallel divergence angle	$\theta_{ }$	7	8	9.5	deg	
Perpendicular divergence angle	θ_{\perp}	24	28	34	deg	
Parallel FFP deviation angle	$\Delta\theta_{ }$	-3	0	+3	deg	$P_o=5\text{mW}$
Perpendicular FFP deviation angle	$\Delta\theta_{\perp}$	-2	0	+2	deg	
Emission point accuracy	$\Delta x \Delta y \Delta z$	-80	0	+80	um	

• Precautions

- Do not operate the device above maximum ratings. Doing so may cause unexpected and permanent damage to the device.
- Take precautions to avoid electrostatic discharge and/or momentary power spikes. A change in the characteristics of the laser or premature failure may result.
- Proper heat sinking of the device assures stability and lifetime. Always ensure that maximum operating temperatures are not exceeded.
- Observing visible or invisible laser beams with the human eye directly, or indirectly, can cause permanent damage. Use a camera to observe the laser.
- No laser device should be used in any application or situation where life or property is at risk in event of device failure.
- Specifications are subject to change without notice. Ensure that you have the latest specification by contacting us prior to purchase or use of the product.

* For reference only. Contents above are subject to change without notice.

AlGaInP Visible Laser Diode

ADL-65078TU-1

6-2D-LD65-001_Rev.01

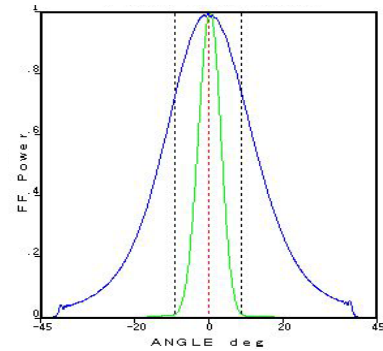
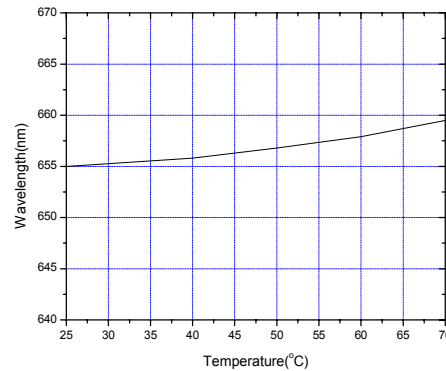
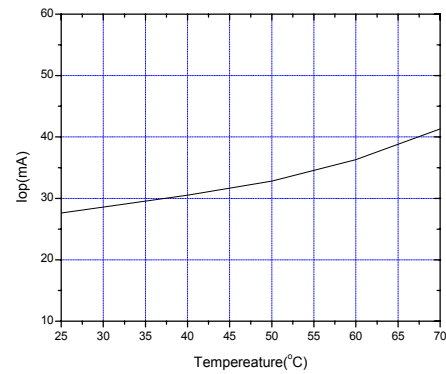
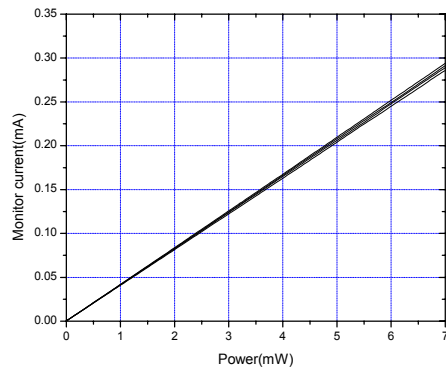
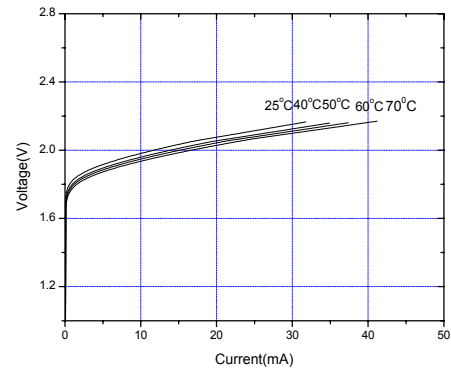
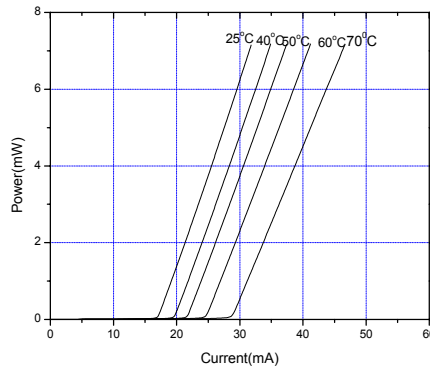

* For reference only. Contents above are subject to change without notice.

10/14 / V2 / HW / arima / 655nm / adl-65078tu-1