

FLEXPOINT® Machine Vision Laser MVPulse Series with Pulse Control Option (PCO)

Increased peak power, up to 5-times in the same laser class.

Having the highest light intensity is a mandatory key in machine vision applications. However, when using laser light, obeying laser class regulations is sometimes a limiting factor.

Laser manufacturers normally classify their lasers in continuous wave operation which is not the most used operation mode together with a camera. The pulse control PCO closes this gap. It allows up to 5-times higher peak power compared to cw mode within the same laser class.



Features

- Save laser classes
- High pulse power, low average optical power
- Pulse control by integrated microcontroller

Applications

- 3D machine vision
- Industrial inspection
- Structured lighting



Specifications

Spectral range	450 nm, 520 nm, 640 nm, 660 nm, 785 nm
Wavelength stability	< 0.25 nm / °C
Output power	10 mW – 100 mW (peak power) 10 mW – 80 mW (peak power) for 450 nm and 520 nm
Power stability	≤ 5% (after warm up at 25 °C)
Peak power increase compared to cw mode in same laser class	5x @ pulse length <0.38 ms, duty cycle <0.2, laser off time >1.52 ms 3x @ pulse length <2.9 ms, duty cycle <0.3, laser off time >5.9 ms 2x @ pulse length <15 ms, duty cycle <0.5, laser off time >15 ms
Beam profile	laser line with uniform power distribution (FOV on request)
Fan angle	5°, 10°, 15°, 20°, 30°, 45°, 60°, 75°, 90°
Line thickness	Standard, DL, DLE, DLSE, TS1, TS2
Line intensity variation	± 20 % related to average power (within 80% of the line)
Line straightness	± 0.1 % (±0.05 as option)
Boresight deviation	≤10 mrad (≤3 mrad as option)
Pointing stability	≤10 µrad/°C (improved pointing stability as option)
Operating voltage	4.5 – 30 VDC 10 – 30 VDC for 450 nm and 520 nm
Current consumption	< 200 mA @5 VDC
Modulation options	digital high/low active, 0 – 20 kHz, pulse length and duty cycle limited, higher frequency on request
Operating temperature	450 nm / 520 nm / 640 nm: 0° to +50 °C, 660 nm / 785 nm: 0° to +60 °C (housing temperature)
Storage temperature	-20 °C to +60 °C
Housing size	see drawings on page 9/10
Housing material	Aluminum (blue anodised, potential free)
Pin / cable color assignment	M12 conector: Pin1: +VDC, Pin3: GND, Pin2: dig. modulation wire: brown: +VDC, blue: GND: black: dig. Modulation
laser class	According to DIN EN 60825-1:2014

Pulse and Monitor/Control Features

The pulse peak power can be increased by the factor 2 / 3 / 5 compared to the maximum continuous wave average power whilst the laser still stays within the limits of laser class 2 or laser class 3R. By increasing the pulse peak power, the maximum pulse length and duty cycle have to be limited.

Figure 1 is a visualization how the pulse peak power can be increased to the limits of laser class 2 and how the pulse length and the duty cycle will change accordingly.

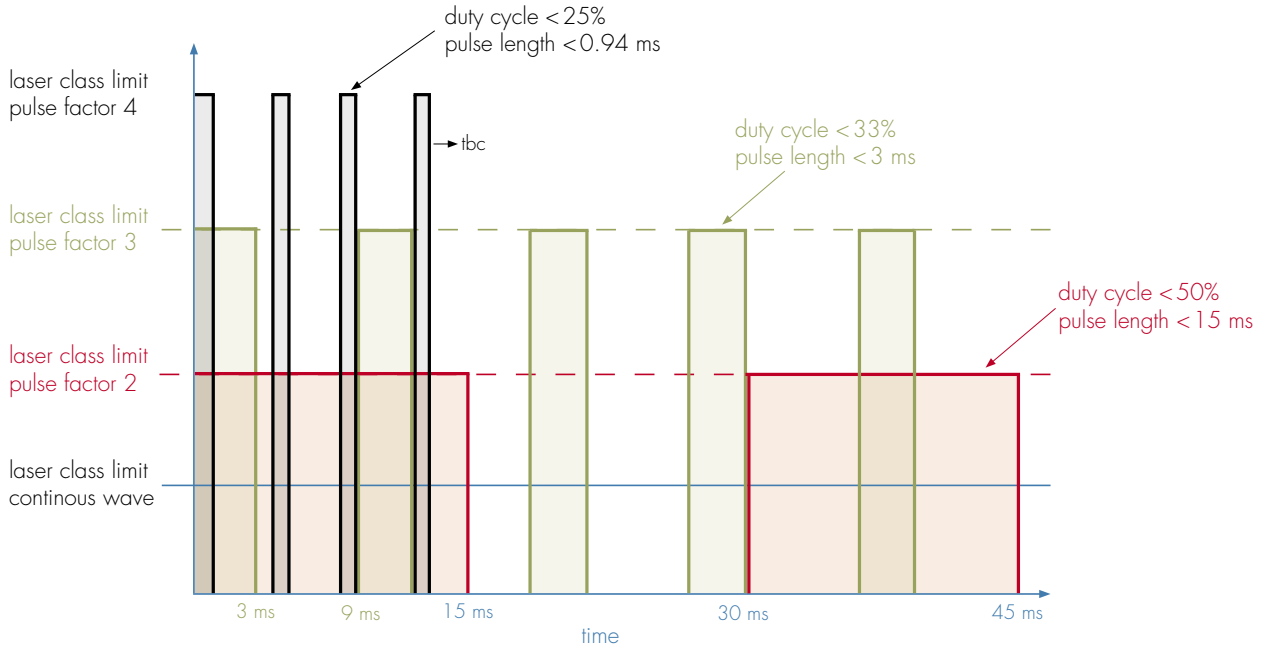

Figure 1: Max. peak power, pulse length and duty cycle for laser class 2

The following graph shows the relation between the pulse increase factor, the duty cycle and the pulse length. Valid for both laser class 2 and laser class 3R.

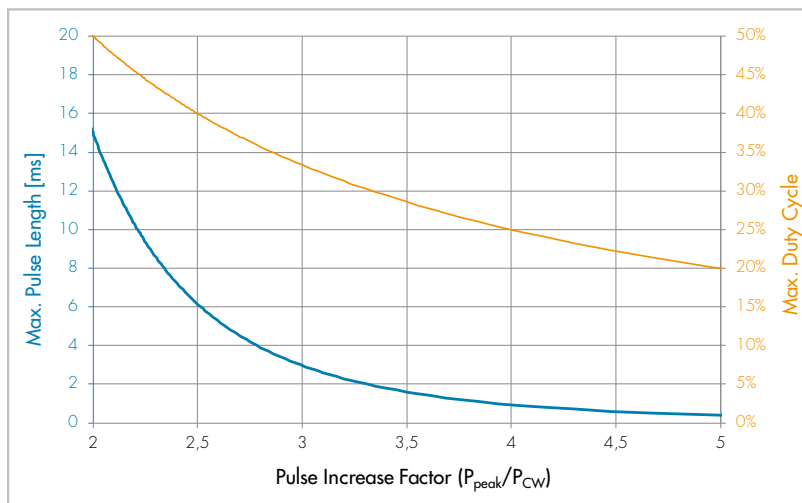

Figure 2: Possible pulse increase factors for laser class 2 and 3R

Pulse increase factor compared to cw	5x	4x	3x	2x
Max. Pulse length [ms]	0.38	0.94	2.96	15.01
Max. Duty Cycle [%]	20	25	33	50
Min. laser off time [ms]	1.52	2.82	5.9	15

The MVpulse driver electronics automatically monitors and controls the pulse modulation function. If the user applies a higher duty cycle or longer pulse length to the modulation input of the laser which would lead to an exceedance of the laser class, the driver electronics will ignore the signal and will limit the laser output power to stay in the specified laser class. Refer to the example below.

$t_{m,on}$ $t_{m,off}$ modulation signal: on time / off time
 $t_{p,on}$ $t_{p,off}$ pulse control: factory preset maximum on time / minimum off time

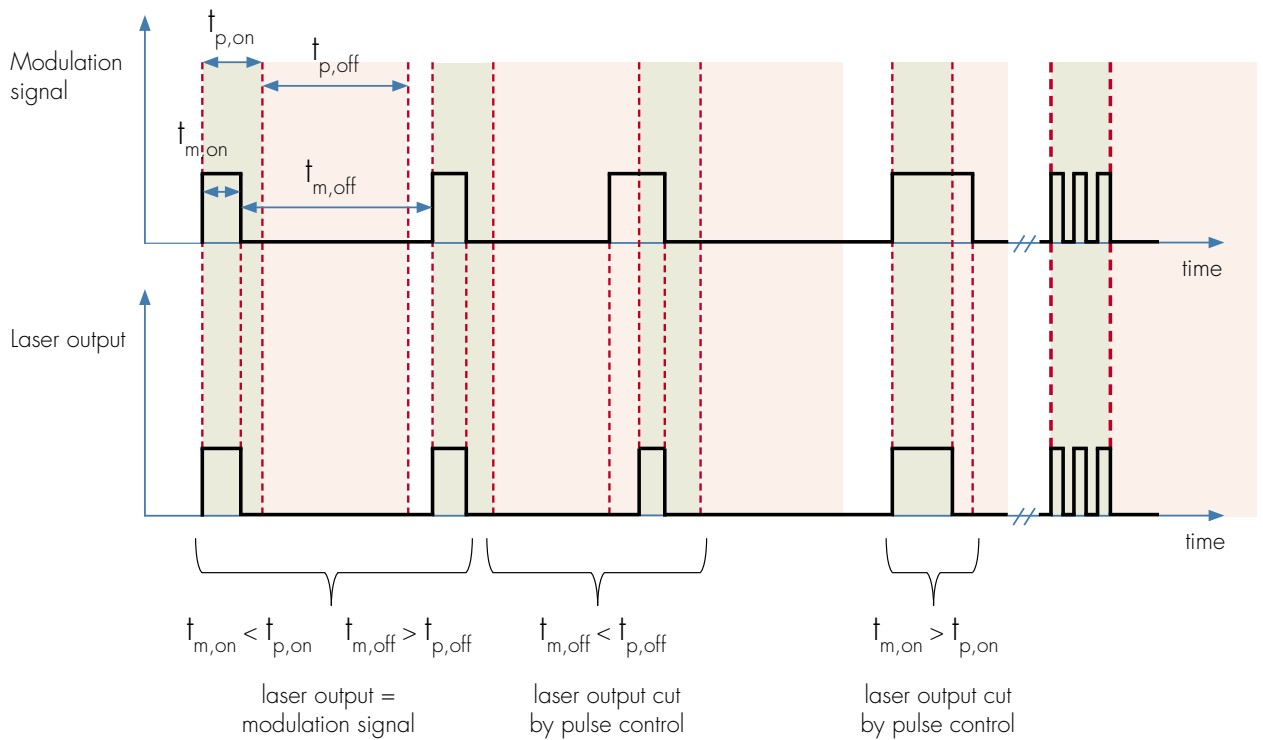

Figure 3: Pulse scheme modulation input versus laser output

Focus Options

MVPulse lasers are available with different focus options to achieve the right combination of line thickness and depth of focus for the application.

The individual options are:

- STD: Standard, good compromise for line thickness vs. depth of focus
- DL: Thin line
- DLE: Thin line enhanced
- DLSE: Thin line super enhanced
- TS1: Enhanced depth of focus
- TS2: Enhanced depth of focus, higher factor

(Abbreviations: LT = line thickness / DOF = depth of focus)

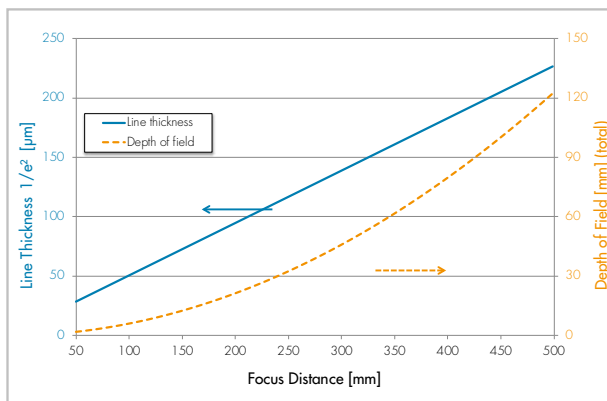

Figure 4:
Standard laser line characteristics
(short range)

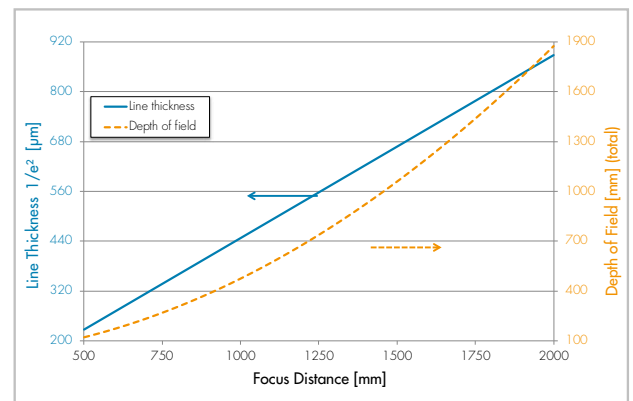

Figure 5:
Standard laser line characteristics
(long range)

To calculate line thickness and DOF, note the value in the graphs above and multiply them by the factors for your requested wavelength, output power, and focus option listed in the following table.

Specifications MVpulse

P _{out} & λ			Focus options (conversion factor related to the reference laser)											
λ [nm]	P _{out} [mW]	Δ λ [nm]	Std		DL		DLE		DLSE		TS1		TS2	
			LT	DOF	LT	DOF	LT	DOF	LT	DOF	LT	DOF	LT	DOF
450	1-80	±10	0,69	0,69	0,45	0,30	0,33	0,16	0,25	0,10	1,49	3,25	2,20	7,06
520	1-80	±10	0,78	0,78	0,53	0,36	0,39	0,19	0,29	0,11	1,71	3,69	2,55	8,23
640	1-20	±5	1,02	1,07	0,69	0,48	0,51	0,27	0,39	0,16	1,65	2,79	2,43	6,08
640	21-30	±5	1,02	1,07	0,69	0,48	0,51	0,27	0,39	0,16	1,47	2,23	2,18	4,87
640	31-100	±5	1,20	1,47	0,80	0,67	0,59	0,36	0,47	0,23	1,65	2,79	2,43	6,08
660	1-30	±5	1,00	1,00	0,67	0,44	0,49	0,24	0,39	0,15	1,51	2,27	2,25	5,07
660	31-100	±5	1,31	1,72	0,88	0,78	0,65	0,42	0,51	0,26	1,51	2,27	2,25	5,07
785	1-10	±10	0,90	0,68	0,61	0,31	0,45	0,17	0,35	0,10	1,65	2,28	2,43	4,96
785	11-100	±10	1,65	2,28	1,12	1,05	0,82	0,57	0,65	0,35	2,00	3,36	2,98	7,45

Abbreviations

- Reference laser (for LT and DOF)
- Laser with standard availability
- Laser available on request

Housing Options

MVpulse lasers can be ordered in two different housing options. All housings can be ordered are available with adjustable or fixed focus.

- ST: Standard housing
- 2H Separate housings for optics and electronics

Housings

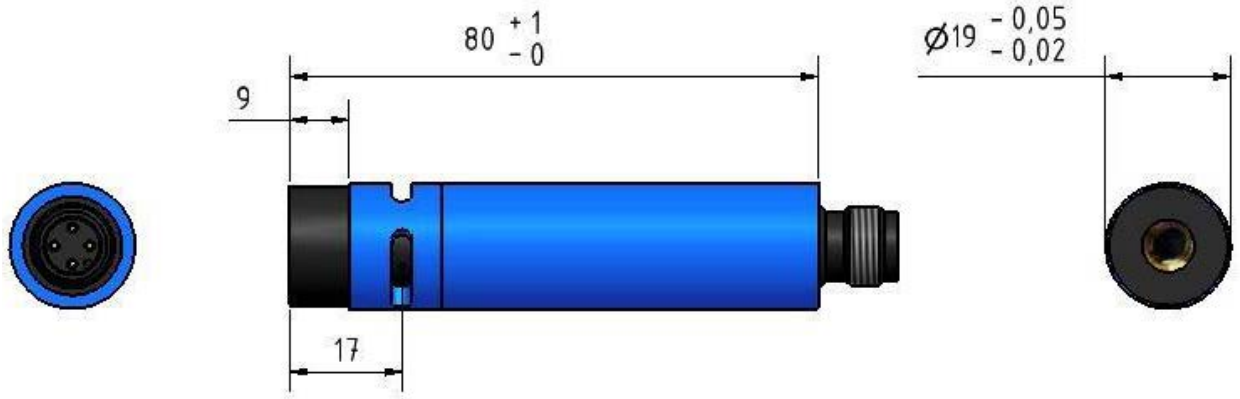

Figure 6: MVpulse with adjustable focus and standard housing

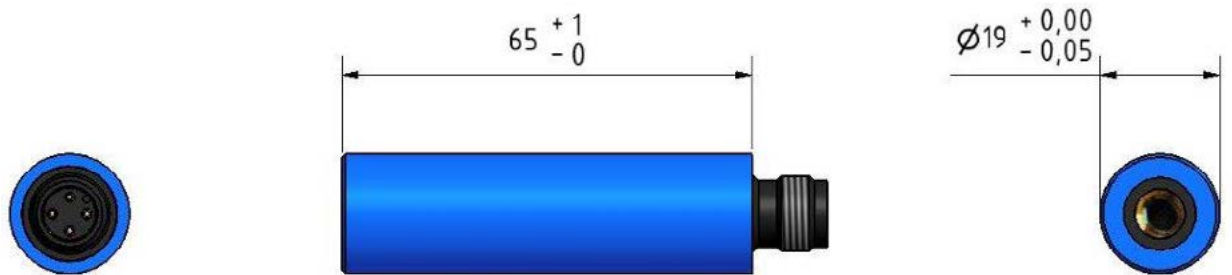

Figure 7: MVpulse with fix focus and standard housing

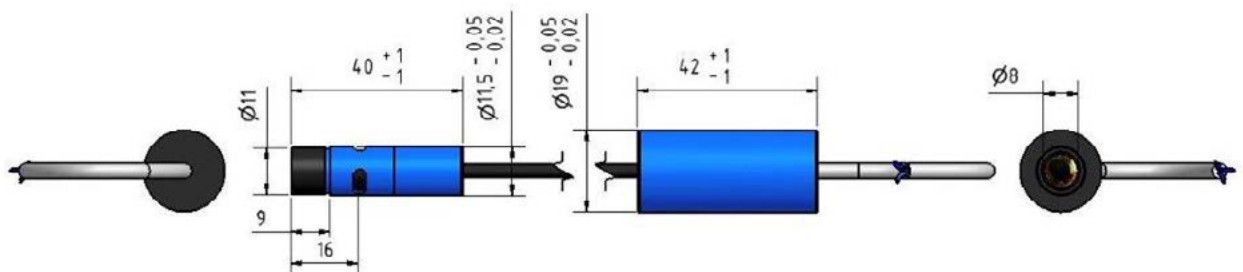

Figure 8: MVpulse with adjustable focus and 2 housings

Housings

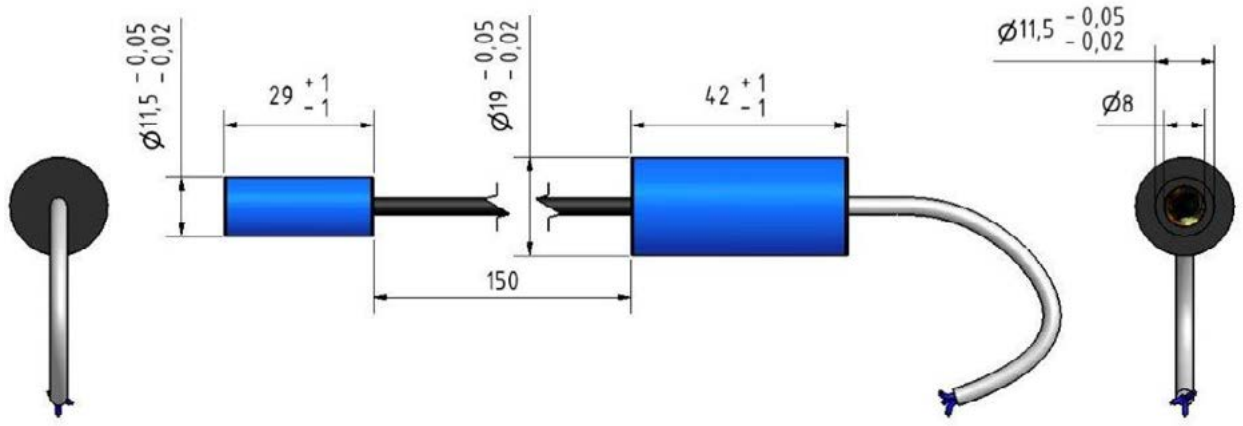

Figure 9: MVpulse with fix focus and 2 housings

Ordering Code MVpulse Series

Series	Housing	Wavelength (nm)	Peak Power (mW)	Modulation/ Power Adjustment	Fan Angle (degree)	Focus (mm)	Optics	Laser Class	Pulse Increase Factor
FP - MVpulse	XXX	XXX	XXX	X	XX	XXX	XXX	X	X
	ST 2H	450 520 640 660 785	1 to 80/100	M = digital Modulation, active low MI = digital Modulation inverted, active high	5 10 15 20 30 45 60 75 90	F = Focusable FYYY = prefocused to YYY, but still focusable FIXYYY = fix focused to YYY	STD TS1 TS2 DL DLE DLSE	1 2 3R	2x 3x 4x 5x