

## ModBox-CBand-28Gb/s-DPSK

C-Band, 28 Gb/s DPSK Reference Transmitter

MODBOX



### FEATURES

- Full C-Band Reference Transmitter
- Up to 28 Gb/s
- Reliable & reproducible measurements
- High eye diagram stability

### APPLICATIONS

- Transmission system test
- Components characterization
- Production test
- R&D laboratories

### OPTIONS

- Tunable Laser source, C-Band, L-Band
- DPSK encoder
- Receiver stage
- Fixed, tunable FSR optical demodulator
- Multi-formats version:  
NRZ & RZ, NRZ & RZ-DPSK, CS-NRZ-DPSK

The ModBox-CBand-28Gb/s-DPSK is an optical modulation unit that generates high performance Differential Phase-Shift Keying (DPSK) optical data streams up to 28 Gb/s. The equipment incorporates a modulation stage based on a high bandwidth LiNbO<sub>3</sub> Mach-Zehnder modulator, coupled with a high performance RF driver and an automatic bias control circuitry. A receiver stage based on a delay line interferometer and balanced detector can be implemented to offer a solution for demodulation of DPSK-encoded optical signals and conversion back into electrical data stream. The ModBox can also receive an internal laser source (DFB, ITLA...).

The ModBox is remotely controlled over a standard USB connection using the software package provided and its friendly Smart interface.

The ModBox-CBand-28Gb/s-DPSK provides R&D and production engineers with state of the art performance and the peace of mind of a turn-key instrument. It can be used as a reference transmitter in optical telecommunications laboratories, or in production test beds.

In addition to the traditional C-Band wavelength range, it is also available in the O-Band.

### Performance Highlights

Parameter	Min	Typ	Max
Operating wavelength	-	C-Band	-
Modulation format	DPSK		
Modulation bandwidth	28 Gb/s		

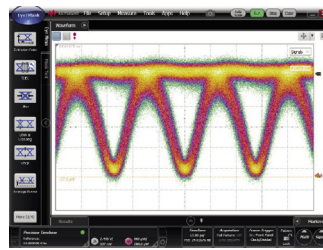

28 Gb/s Optical DPSK Eye Diagram

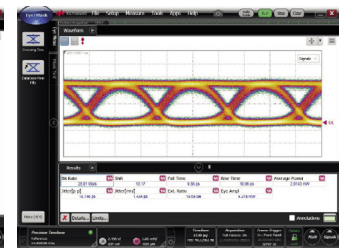

28 Gb/s Electrical Demodulated Eye Diagram

**ModBox-CBand-28Gb/s-DPSK**  
C-Band, 28 Gb/s DPSK Reference Transmitter

MODBOX

Functional Block Diagram

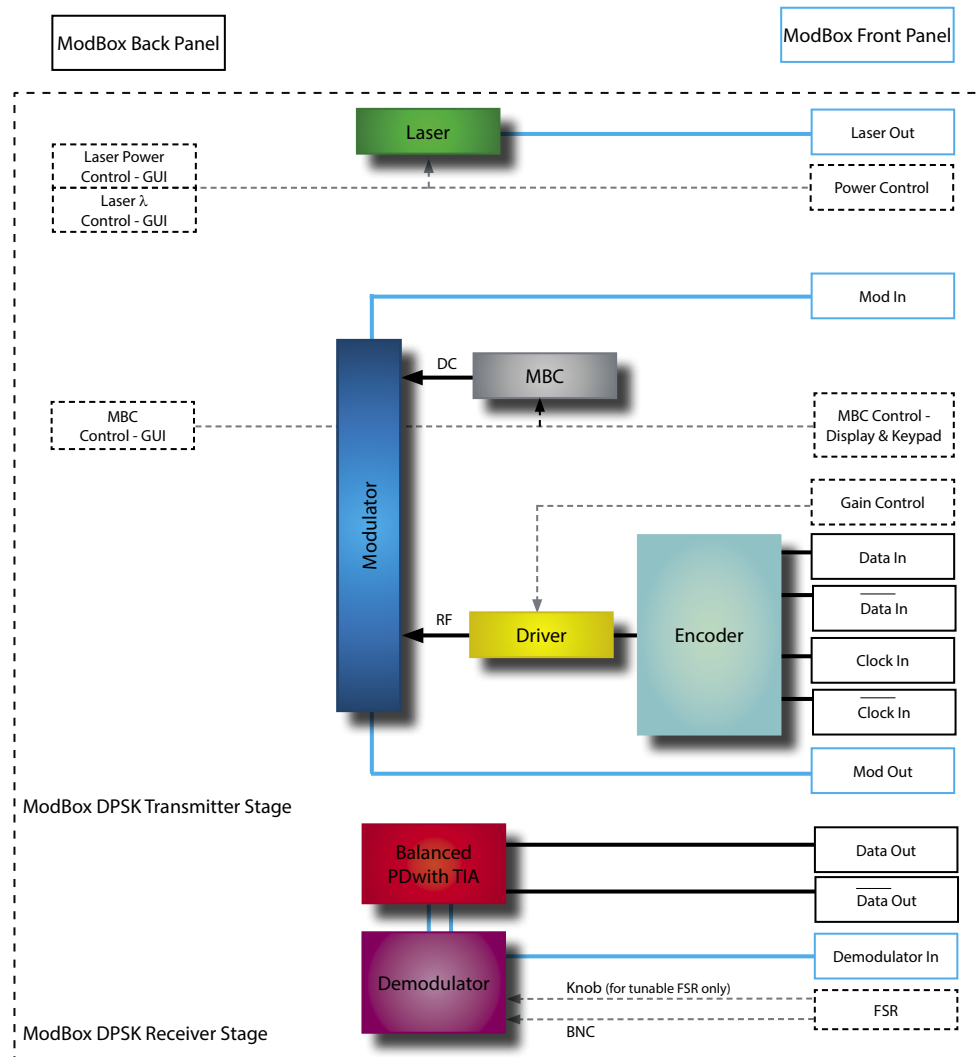

The ModBox-CBand-28Gb/s-DPSK integrates:

- a high bandwidth, chirp-free, X-cut LiNb<sub>3</sub> Mach-Zehnder modulator,
- a high bandwidth NRZ RF driver with gain level adjustment for eye diagram optimization,
- a bias control circuit to lock the Mach-Zehnder modulator and ensure a highly stable output optical signal,
- an optional laser source, DFB or tunable type, with its high precision driver that allows control of output power,
- an optional electrical encoder,
- an optional receiver stage composed of one optical demodulator (tunable FSR) and balanced photodiodes.

## ModBox-CBand-28Gb/s-DPSK

C-Band, 28 Gb/s DPSK Reference Transmitter

ModBox

### Input Electrical Specifications User supplied, not a ModBox specification

Parameter	Symbol	Condition	Min	Typ	Max	Unit
Data-rate	PRBS	NRZ	0.1	-	28	Gb/s
Input voltage (Data & Clock)	$V_{IN-Data}$ $V_{IN-Clock}$	AC coupled - Single ended 50 $\Omega$	-	300	-	mVpp
		AC coupled - Differential 100 $\Omega$	-	600	-	mVpp
Rise / fall time	$t_r / t_f$	20 % - 80 %	-	13	18	ps
Cross point	-	-	45	50	55	%

### Input Optical Specifications User supplied, not a ModBox specification

Parameter	Symbol	Condition	Min	Typ	Max	Unit
Operation	$\lambda$	CW	C-Band			-
Polarization	-	-	Linear and controlled			-
Power	P	-	-	10	16	dBm
Side Mode Supression Ratio	SMSR	-	30	-	-	dB
Spectrum linewidth	$\Delta\lambda$	FWHM	-	1	-	MHz
Polarization extinction ratio	PER	-	-	19	-	dB

### Modulated Output Optical Specifications Specifications below are given with embedded 1550 nm

Parameter	Symbol	Condition	Min	Typ	Max	Unit
Data-rate	-	DPSK - Differential encoder embedded	0.1	-	28	Gb/s
Dynamic Signal to Noise Ratio	SNR	-	13	16	-	dB
Rise / fall time	$t_r / t_f$	20 % - 80 %	-	15	18	ps
Optical return loss	ORL	-	-40	-45	-	dB
Insertion loss	IL	At maximum modulator transmission	-	5	-	dB
Static extinction ratio	SER	-	20	-	-	dB
Electrical return loss	ERL	-	10	-	-	dB

The encoder option is a NRZ differential coder for high data rate application. The device has two high frequency differential inputs (Data & Clock). The encoder can be either used is 50  $\Omega$  single ended or 100  $\Omega$  differential. The input data stream is synchronized by the clock and electrically coded to a differential format. If a logical zero is present to the input, the output remains unchanged:  $Q_{n+1}=Q_n$ . If a logical one is present to the data input, the output value is changed at every rising edge of the clock: a constant one to the input gives a continuous series of 01010 to the output.

### Absolute Maximum Ratings - ModBox DPSK Transmitter without any options

Stresses in excess of the absolute maximum ratings can cause permanent damage to the device. These are absolute stress ratings only. Functional operation of the device is not implied at these or any other conditions in excess of those given in the operational sections of the data sheet. Exposure to absolute maximum ratings for extended periods can adversely affect device reliability.

Parameter	Symbol	Min	Max	Unit
Input voltage (Data / Clock)	$V_{IN}$	-0.5	4.6	V
Optical input power	$OP_{in}$	-	20	dBm

## ModBox-CBand-28Gb/s-DPSK

### C-Band, 28 Gb/s DPSK Reference Transmitter

**MODBOX**

#### Demodulated Output Optical Specifications Measured with ModBox DPSK Transmitter and Receiver Stages.

Parameter	Symbol	Condition	Min	Typ	Max	Unit
Operation	$\lambda$	-	C-Band			-
Maximum optical power	$OP_{IN}$	-	-	-	5	dBm
Data-rate	-	Differential	6	-	28	Gb/s
FSR tuning range	$\Delta FSR$	Manual adjustment knob (front panel)	-	-	1.5	-
Phase tuning voltage	-	-	0	-	4	V
Optical eye amplitude	-	Differential with TIA - $OP_{IN} = 3.5$ dBm	-	-	1 800	mVpp

#### Optional C-Band DFB Laser Specifications

Parameter	Symbol	Condition	Min	Typ	Max	Unit
Wavelength	$\lambda$	Other wavelength on request	1550.12 nm - ITU CH 34			-
Laser type	-	-	DFB			-
Optical output power	-	CW	-	40	-	mW
Spectrum linewidth	$\Delta\lambda$	FWHM	-	-	1	MHz
Optical return loss	ORL	-	30	35	-	dB
Side mode suppression ratio	SMSR	-	30	-	-	dB
Optical output power adjustment	$P_{CW}$	Front & back panels with GUI	20	-	40	mW
Wavelength laser tuning range	-	Back panel with GUI	-	0.8	1	nm

#### C-Band Tunable Laser Specifications

Parameter	Symbol	Condition	Min	Typ	Max	Unit
Laser type	-	-	Tunable			-
Wavelength	$\lambda$	Embedded by default	1527.60	-	1565.50	nm
Wavelength accuracy	$\Delta\lambda_{acc}$	-	-1.5	-	1.5	GHz
Spectrum linewidth	$\Delta\lambda$	FWHM @-3 dB, instantaneous	-	-	100	kHz
Optical output power	-	CW	5	-	35	mW
Optical output power adjustment	-	-	0	-	100	%
Optical Return Loss	ORL	-	30	-	-	dB
Side Mode Suppression Ratio	SMSR	-	40	-	-	dB

## ModBox-CBand-28Gb/s-DPSK C-Band, 28 Gb/s DPSK Reference Transmitter

ModBox

### 28 Gb/s DPSK Modulation and Demodulation Set-up

The following equipment was used in obtaining these results:

- Keysight Infinium DCA-X 86100D scope with high precision timebase
- Anritsu synthesizer MG3694C
- Anritsu Signal Analyzer MP1800A
- Keysight Receiver 86116-C module for high speed signal detection
- EDFA and filter
- Delay line interferometer with piezoelectric driver

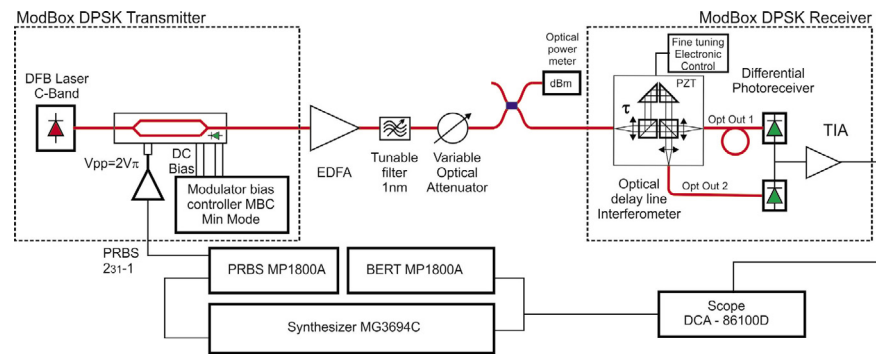

### 28 Gb/s Modulated Eye Diagrams

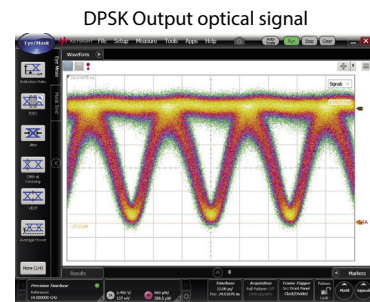
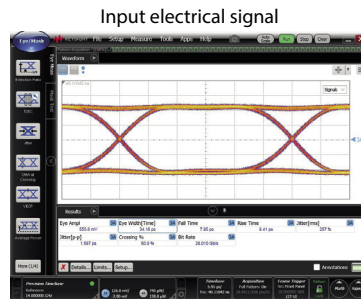

### 28 Gb/s Demodulated Eye Diagrams (at the photodiode output port, without TIA)

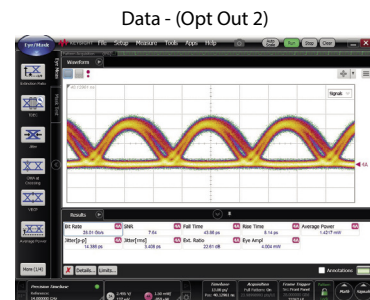
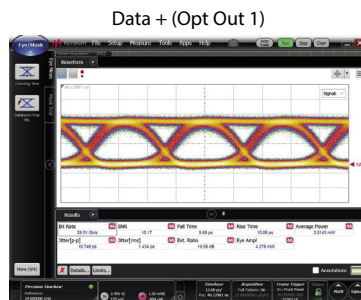

## ModBox-CBand-28Gb/s-DPSK

C-Band, 28 Gb/s DPSK Reference Transmitter

MODBOX

### Interfaces, Dimensions and Compliance

Interfaces	
Optical	Polarization maintaining fiber, PM1550 / SMF58 (demodulator)
RF input (Data & Clock)	Differential SMA female RF connector 100 Ω – Single Ended SMA female RF connector 50 Ω
Control	Smart Interface (front panel) & GUI (USB typeB)
	MBC, Driver Gain, Laser (power & wavelength), optical demodulator fine adjustment, TIA driver gain
Power supply	100-120V/220-240 automatic switch 50-60Hz (Rear panel)
Dimensions / Weight	Rack 19" x 6U, Depth=375mm / 6 kg

### Ordering information

#### ModBox-CBand-DPSK-XX-Rx

CBand = Full band of operation, embeds laser, C-Band Tunable laser by default  
 XX = Data-rate: 12.5Gb/s up to 12 Gb/s- 28Gb/s up to 28 Gb/s  
 RX = Receiver option

#### Opt-XXTun

Tunable laser option  
 XX = Optional additional laser band : C : C-Band

#### Opt-DFB

DFB laser option  
 Optional additional laser at 1550.12 nm

#### Opt-YY

YY = Output connectors, FA : FC/APC - FC : FC/UPC - SA : SC/APC- SC : SC/UPC

### About us

iXBlue Photonics produces specialty optical fibers and Bragg gratings based fiber optics components and provides optical modulation solutions based on the company lithium niobate (LiNbO<sub>3</sub>) modulators and RF electronic modules.

iXBlue Photonics serves a wide range of industries: sensing and instruments, defense, telecommunications, space and fiber lasers as well as research laboratories all over the world.

iXblue reserves the right to change, at any time and without notice, the specifications, design, function or form of its products described herein. All statements, specification, technical information related to the products herein are given in good faith and based upon information believed to be reliable and accurate at the moment of printing. However the accuracy and completeness thereof is not guaranteed. No liability is assumed for any inaccuracies and as a result of use of the products. The user must validate all parameters for each application before use and he assumes all risks in connection with the use of the products