

## DRIVER

# DR-DG-40-MO

## 40 Gbps NRZ Medium Output Voltage Driver

The DR-DG-40-MO is a driver module optimized for digital applications at 40 Gbps – 44 Gbps data rate. It exhibits an output voltage of  $6.3 V_{pp}$  and a broad bandwidth of 40 GHz.

The DR-DG-40-MO is housed in a compact package that integrates voltage regulators allowing for flexible biasing, while internal bias sequencing circuitry assures robust operation and single voltage power supply for maximum ease of use. It features two control inputs: one for gain control, the second one for crossing point adjustment. The RF connectors are V type, allowing easy and repeatable connections.

The DR-DG-40-MO combines high performance and user friendliness, it is the ideal device to drive 40 Gbps modulators and to obtain widely opened optical eye diagrams with short jitter and high SNR.

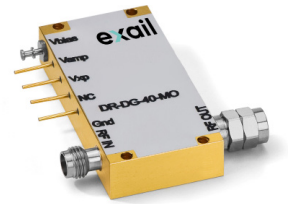

### Features

- Output voltage  $6.3 V_{pp}$
- Flat gain up to 40 GHz
- Single voltage power supply
- Gain and crossing point adjustment

### Applications

- LiNbO<sub>3</sub> & InP modulators
- 40 Gbps – 44 Gbps NRZ / RZ
- SONET OC-768 / SDH-256
- Research & Development

### Options

- Heat-sink
- Analog version
- Low output voltage version for EAM

### Related Equipments

- MX-LN-40, MXAN-LN-40 modulators
- MBC-DG Automatic Bias Controllers

### Performance Highlights

Parameter	Min	Typ	Max	Unit
Cut-off frequencies	50 k	-	40 G	Hz
Output voltage	-	6.3	-	$V_{pp}$
Gain	-	26	-	dB
Saturated power	20	-	-	dBm
Added jitter	-	0.75	-	ps
Rise / Fall times	-	9	12	ps

Measurements for  $V_{bias} = 8 V$ ,  $V_{amp} = 1.5 V$ ,  $V_{xp} = 2 V$ ,  $I_{bias} = 300 mA$

### 40 Gbps Output Response

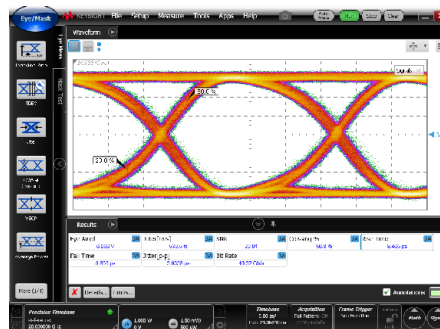

DRIVER | DR-DG-40-MO | 2/6

**DR-DG-40-MO**

40 Gbps NRZ Medium Output Voltage Driver

**DC Electrical Characteristics**

Parameter	Symbol	Min	Typ	Max	Unit
Supply voltage (fixed)	$V_{bias}$	7	8	12	V
Current consumption	$I_{bias}$	-	300	350	mA
Gain control voltage	$V_{amp}$	0	1.5	2	V
Cross Point control voltage	$V_{xp}$	0	2	2.5	V

**Electrical Characteristics**

Parameter	Symbol	Condition	Min	Typ	Max	Unit
Lower frequency	$f_{3db, lower}$	-3 dB point	-	-	50	kHz
Upper frequency	$f_{3db, upper}$	-3 dB point	36	40	-	GHz
Gain	$S_{21}$	Small signal	-	26	-	dB
Gain ripple	-	$f < 40$ GHz	-	$\pm 1.5$	-	dB
Input return loss	$S_{11}$	$50 \text{ MHz} < f < 30 \text{ GHz}$	-	-10	-	dB
Output return loss	$S_{22}$	$50 \text{ MHz} < f < 30 \text{ GHz}$	-	-10	-	dB
Saturated power	$P_{sat}$	$V_{in} = 0.45 V_{pp}$	20	-	-	dBm
Output voltage	$V_{out}$	$V_{in} = 0.45 V_{pp}$	-	6.3	6.5	$V_{pp}$
Rise / Fall time	$t_r / t_f$	20 % - 80 %	-	9	12	ps
Added Jitter	$J_{RMS}$	$J_{RMS} = \sqrt{J_{RMS-total}^2 - J_{RMS-source}^2}$	-	0.75	-	ps
Power dissipation	$P$	$V_{out} = 6.3 V_{pp}$	-	2.4	-	W

Conditions:  $V_{in} = 0.5 V_{pp}$ ,  $T_{amb} = 25^\circ\text{C}$ , 50 W system**Absolute Maximum Ratings**

Stresses in excess of the absolute maximum ratings can cause permanent damage to the device. These are absolute stress ratings only. Functional operation of the device is not implied at these or any other conditions in excess of those given in the operational sections of the data sheet. Exposure to absolute maximum ratings for extended periods can adversely affect device reliability.

Parameter	Symbol	Min	Max	Unit
RF input voltage	$V_{in}$	-	1	$V_{pp}$
Supply voltage	$V_{bias}$	0	12	V
DC current	$I_{bias}$	0	350	mA
Gain control voltage	$V_{amp}$	0	2	V
Cross Point control voltage	$V_{xp}$	0	2.5	V
Power dissipation	$P_{diss}$	-	4.2	W
Operating temperature	$T_{op}$	0	40	$^\circ\text{C}$
Storage temperature	$T_{st}$	-20	+70	$^\circ\text{C}$



DRIVER | DR-DG-40-MO | 3/6

# DR-DG-40-MO

### S<sub>21</sub> Parameter Curve

Conditions: V<sub>bias</sub> = 8 V, V<sub>amp</sub> = 1.5 V, V<sub>xp</sub> = 2 V, I<sub>bias</sub> = 300 mA

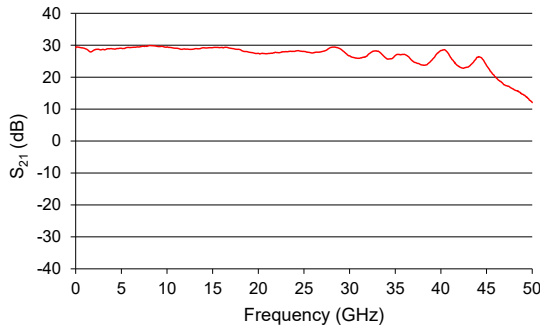

### Group Delay Parameter Curve

Conditions: V<sub>bias</sub> = 8 V, V<sub>amp</sub> = 1.5 V, V<sub>xp</sub> = 2 V, I<sub>bias</sub> = 300 mA

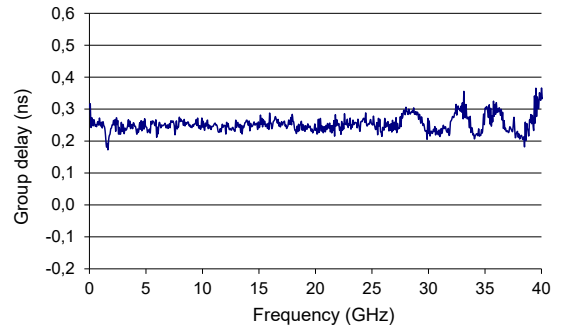

### S<sub>22</sub> Parameter Curve

Conditions: V<sub>bias</sub> = 8 V, V<sub>amp</sub> = 1.5 V, V<sub>xp</sub> = 2 V, I<sub>bias</sub> = 300 mA

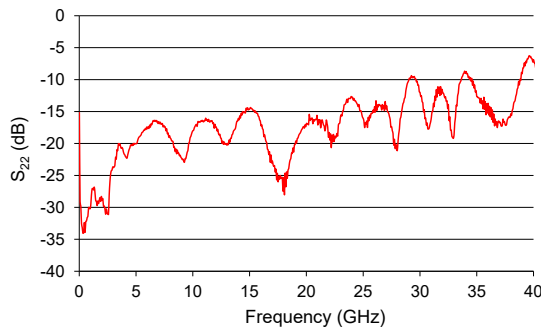

### S<sub>11</sub> Parameter Curve

Conditions: V<sub>bias</sub> = 8 V, V<sub>amp</sub> = 1.5 V, V<sub>xp</sub> = 2 V, I<sub>bias</sub> = 300 mA

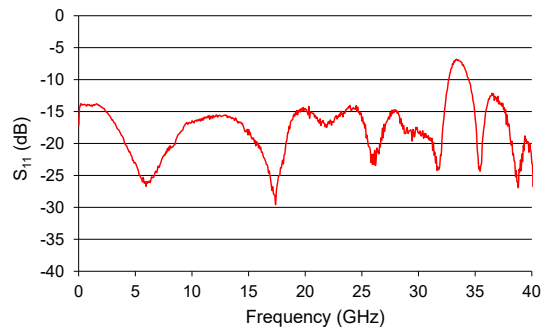

### S<sub>12</sub> Parameter Curve

Conditions: V<sub>bias</sub> = 8 V, V<sub>amp</sub> = 1.5 V, V<sub>xp</sub> = 2 V, I<sub>bias</sub> = 300 mA

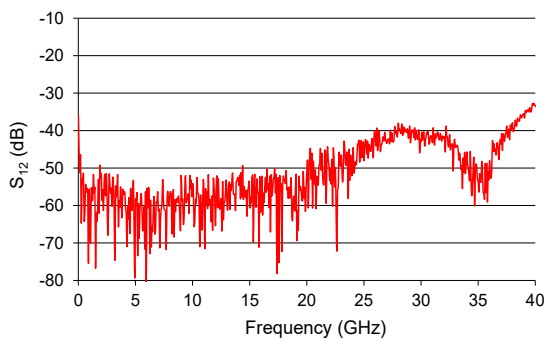

### Typical Output Voltage Amplitude VS Gain

Conditions: V<sub>bias</sub> = 8 V, V<sub>xp</sub> = 2 V

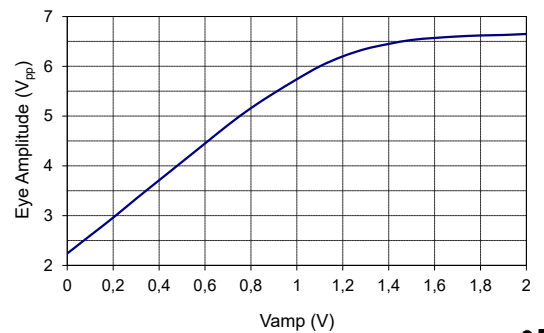

DRIVER | DR-DG-40-MO | 4/6

# DR-DG-40-MO

Eye Diagrams

## 28 Gbps data rate

Conditions: Ratio 1/2, Pattern 2<sup>31</sup>-1

$$V_{\text{bias}} = 8 \text{ V}, V_{\text{amp}} = 1.5 \text{ V}, V_{\text{xp}} = 2 \text{ V}, I_{\text{bias}} = 300 \text{ mA}$$

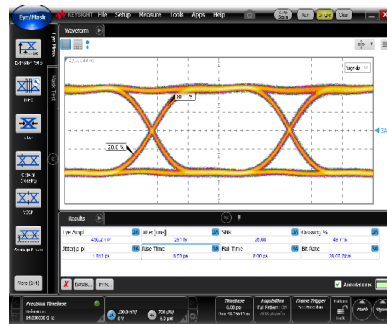

Input signal  
Eye amplitude = 0.45 V<sub>pp</sub>

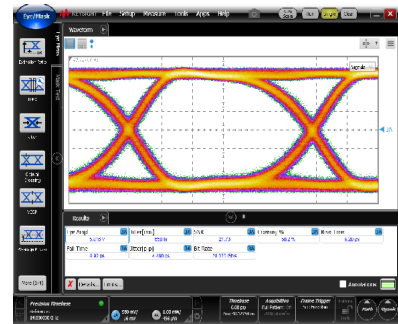

Output response  
Eye amplitude = 5.8 V<sub>pp</sub>

## 40 Gbps data rate

Conditions: Ratio 1/2, Pattern 2<sup>31</sup>-1

$$V_{\text{bias}} = 8 \text{ V}, V_{\text{amp}} = 1.5 \text{ V}, V_{\text{xp}} = 2 \text{ V}, I_{\text{bias}} = 300 \text{ mA}$$

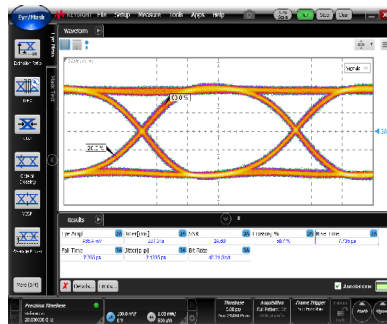

Input signal  
Eye amplitude = 0.45 V<sub>pp</sub>

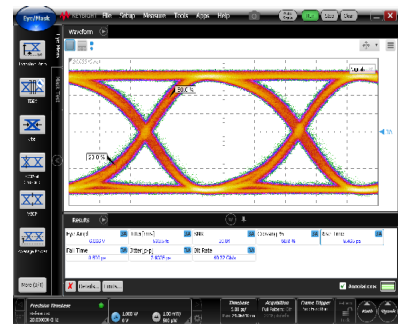

Output response  
Eye amplitude = 6 V<sub>pp</sub>



DRIVER | **DR-DG-40-MO** | 5/6  
Electrical Schematic Diagram

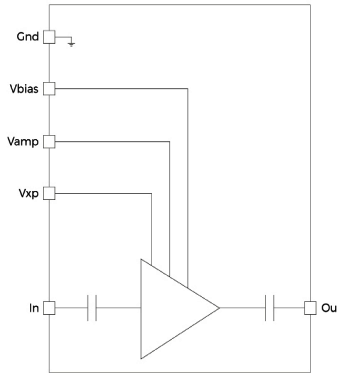

**Mechanical Diagram and Pinout**

All measurements in mm

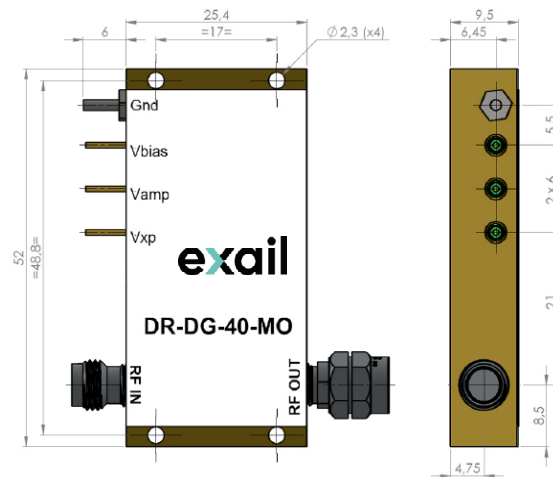

The heat-sinking of the module is necessary. It's user responsibility to use an adequate heat-sink. Refer to page 6 for Exail recommended heat-sink.

Port	Function	Unit
IN	RF In	Female v connector
OUT	RF Out	Male V connector
V <sub>bias</sub>	Power supply voltage	Set a typical operating specification
V <sub>amp</sub>	Output voltage amplitude adjustment	Adjust for gain control tuning
V <sub>amp</sub>	Output voltage cross point adjustment	Adjust for cross point control tuning

**exail**

DRIVER | **DR-DG-40-MO** | 6/6

**Mechanical Diagram and Pinout with HS-MO4 Heat-sink**

All measurements in mm

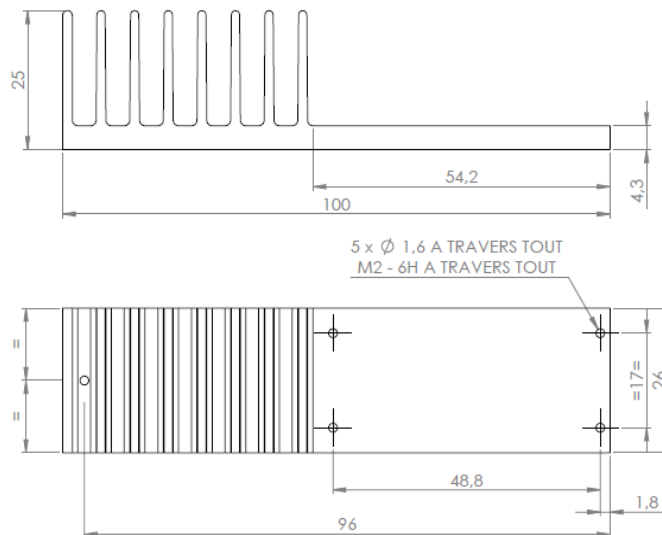
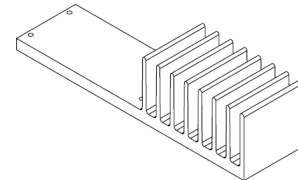

**About us**

Exail Photonics produces specialty optical fibers and Bragg gratings based fiber optics components and provides optical modulation solutions based on the company lithium niobate (LiNbO<sub>3</sub>) modulators and RF electronic modules. Exail Photonics serves a wide range of industries: sensing and instruments, defense, telecommunications, space and fiber lasers as well as research laboratories all over the world.

Exail reserves the right to change, at any time and without notice, the specifications, design, function or form of its products described herein. All statements, specification, technical information related to the products herein are given in good faith and based upon information believed to be reliable and accurate at the moment of printing. **However, Exail provides no warranty (whether express or implied or statutory) as to the description, sufficiency, accuracy or completeness, merchantability or fitness for a particular purpose of any information or specification detailed herein.** No liability is assumed for any inaccuracies and/or as a result of use of the products. The user must validate all parameters for each application before any use and he **shall** assume all risks and responsibilities in connection with the use of the products.



01\_2023\_ED5 / 00024991