

DRIVER

DR-PL-20-MO

Pulse Medium Output voltage Driver Module

The DR-PL-20-MO RF drivers are amplifiers module designed to drive LiNbO₃ optical modulators so as to generate undistorted optical pulses.

Electrical pulsed signals differ from classical telecom signals by long periods with no signal, when telecom signals are usually well balanced in 1 and 0. They also differ from analog signal by a wider frequency content. In order to generate clean optical pulses with sharp edges, sustained high and low levels and no overshoot, pulsed signals do require specific amplifiers.

The DR-PL-20-MO driver is optimized for low and high Pulse Repetition Frequency (PRF) signals from 10 Hz to 1 GHz. The bandwidth up to 20 GHz accommodates 50 ps narrow pulse width with short rise and fall time (down to 30 ps) and can withstand longer pulses up to 10 ns.

The DR-PL-20-MO drivers come in compact connectorized modules that match directly with Exail modulators, they use a single voltage power supply for ease and safety of use and feature an output voltage control for maximum flexibility. An optional heat-sink is proposed as an accessory.



Features

- Specific design for pulse signals
- Accomodate a variety of pulse formats
- High pulse fidelity

Applications

- Pulse generation
- Pulse picking
- Spectroscopy
- Lidar

Options

- Heat-sink

Performance Highlights

Parameter	Min	Typ	Max	Unit
Cut-off frequencies	45 k	-	18 G	Hz
Output voltage amplitude	-	-	5.2	Vpp
Gain	28	30	-	dB
Pulse repetition frequency	10	-	1 G	Hz
Pulse width	60 p	-	10 n	s
Rise / Fall time	-	20	35	ps

Electrical pulse diagram

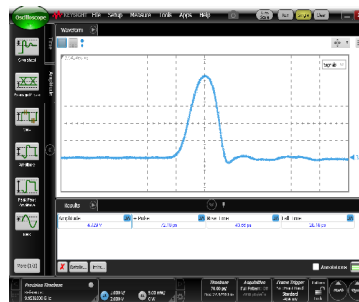

exail

DRIVER | DR-PL-20-MO | 2/6

DR-PL-20-MO

Pulse Medium Output voltage Driver Module

DC Electrical Characteristics

Parameter	Symbol	Min	Typ	Max	Unit
Supply voltage (fixed)	V_{bias}	-	12	-	V
Supply current	I_{bias}	-	320	400	mA
Output amplitude control voltage	V_{amp}	0	-	1.2	V
Output pulse adjustment voltage	V_{xp}	0	0.8	1.1	V

Electrical Characteristics

Parameter	Symbol	Condition	Min	Typ	Max	Unit
Lower frequency	$f_{3dB, lower}$	-3 dB point	45	50	-	kHz
Upper frequency	$f_{3dB, upper}$	-3 dB point	18	20	-	GHz
Gain	S_{21}	Small signal, $P_{in} = -30$ dBm	28	30	-	dB
Gain ripple	-	$f < 17$ GHz	-	± 1.5	-	dB
Input return loss	S_{11}	$50 \text{ kHz} < f < 12 \text{ GHz}$	-	-	-10	dB
Output return loss	S_{22}	$50 \text{ kHz} < f < 20 \text{ GHz}$	-	-	-10	dB
Output pulse amplitude	V_{out}	$V_{in} = 250 \text{ mV}_{pp}$, by V_{amp} adjustment	1.5	4.5	5.2	V_{pp}
Sat output pulse amplitude	V_{out}	$V_{in} = 500 \text{ mV}_{pp}$	-	-	5.4	V_{pp}
Pulse repetition frequency	PRF	Duty-cycle $< 0.1\%$	10	-	1 G	Hz
Pulse width	PW	$10 \text{ Hz} < \text{PRF} < 1 \text{ GHz}$	60 p	-	10 n	s
Rise / Fall time	t_r / t_f	20 % - 80 %	-	20	35	ps
Power dissipation	P	-	-	3.8	5.2	W

Conditions: S parameters -30 dBm, $T_{amb} = 25^\circ\text{C}$, 50 Ω system**Absolute Maximum Ratings**

Stresses in excess of the absolute maximum ratings can cause permanent damage to the device. These are absolute stress ratings only. Functional operation of the device is not implied at these or any other conditions in excess of those given in the operational sections of the data sheet. Exposure to absolute maximum ratings for extended periods can adversely affect device reliability.

Parameter	Symbol	Min	Max	Unit
RF input voltage	V_{in}	-	0.5	V_{pp}
Supply voltage	V_{bias}	-	13	V
DC current	I_{bias}	-	0.4	A
Pulse amplitude control	V_{amp}	0	1.2	V
Pulse adjustment control	V_{xp}	0	1.1	V
Power dissipation	P_{diss}	-	5.2	W
Operating temperature	T_{op}	0	+40	$^\circ\text{C}$
Storage temperature	T_{st}	-20	+70	$^\circ\text{C}$



DRIVER | DR-PL-20-MO | 3/6

DR-PL-20-MO

S_{21} and Group Delay Parameter Curves

Conditions: $V_{bias} = 12\text{ V}$, $V_{amp} = 1.2\text{ V}$, $V_{xp} = 0.8\text{ V}$, $I_{bias} = 300\text{ mA}$

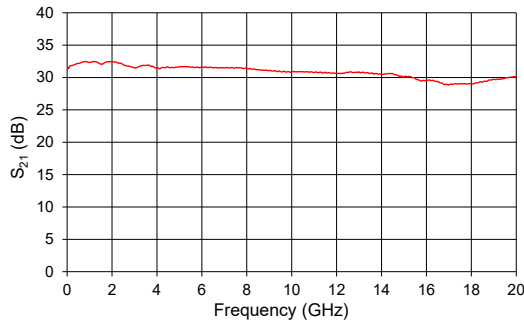

Group Delay Parameter Curve

Conditions: $V_{bias} = 12\text{ V}$, $V_{amp} = 1.2\text{ V}$, $V_{xp} = 0.8\text{ V}$, $I_{bias} = 300\text{ mA}$

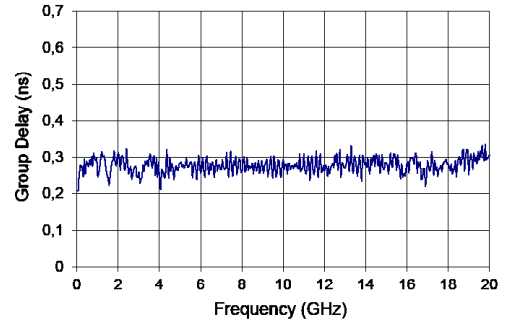

S_{22} Parameter Curve

Conditions: $V_{bias} = 12\text{ V}$, $V_{amp} = 1.2\text{ V}$, $V_{xp} = 0.8\text{ V}$, $I_{bias} = 300\text{ mA}$

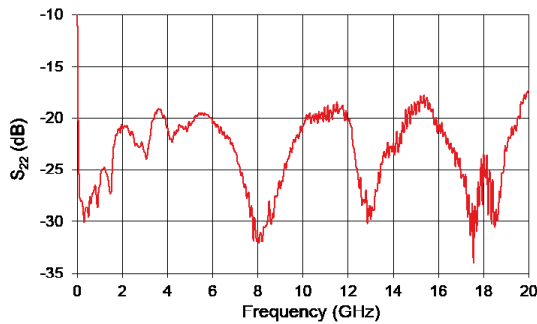

S_{11} Parameter Curve

Conditions: $V_{bias} = 12\text{ V}$, $V_{amp} = 1.2\text{ V}$, $V_{xp} = 0.8\text{ V}$, $I_{bias} = 300\text{ mA}$

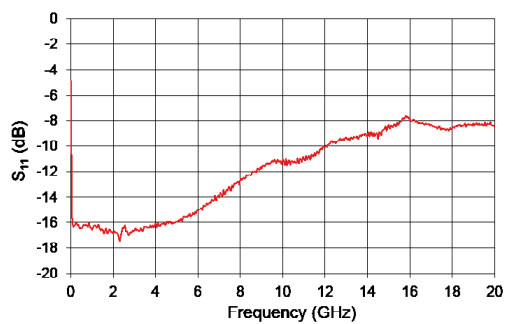

S_{12} Parameter Curve

Conditions: $V_{bias} = 12\text{ V}$, $V_{amp} = 1.2\text{ V}$, $V_{xp} = 0.8\text{ V}$, $I_{bias} = 300\text{ mA}$

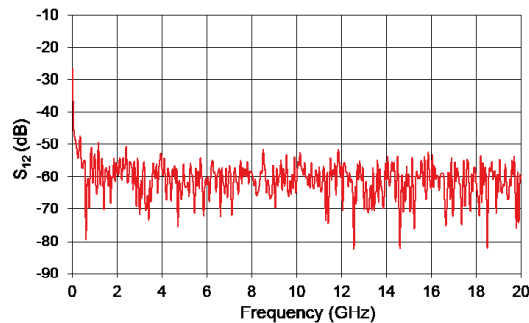

Typical Output Voltage Amplitude vs V_{amp}

Conditions: $V_{bias} = 12\text{ V}$, $V_{xp} = 0.8\text{ V}$, $V_{in} = 0.3\text{ V}_{pp}$

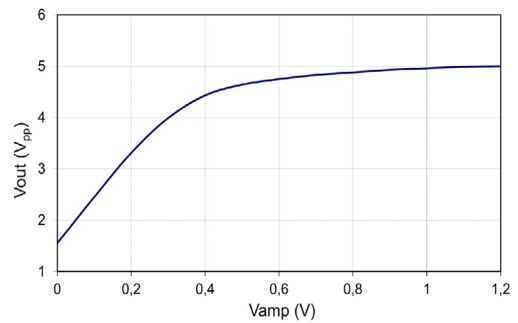



DRIVER | DR-PL-20-MO | 4/6

DR-PL-20-MO

Pulses measurements

The input electrical signal is generated by Anritsu MP1800A. Input and output signals measured using Keysight 86100D.

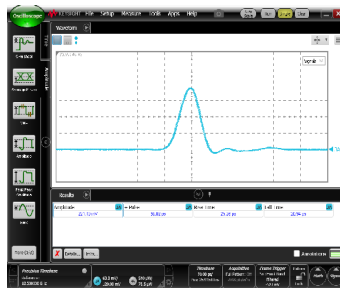
Low frequency repetition rate with a short pulse width of PW = 60 ps



Input signal: Pulse amplitude = 0.22 V_{pp}, Rise time = 24 ps

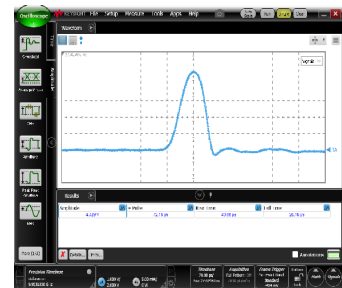

Output response: Pulse amplitude = 4.7 V_{pp}, Rise time = 32 ps

Low frequency repetition rate with a short pulse width of PW = 1 ns



Input signal: Pulse amplitude = 0.25 V_{pp}, Rise time = 32 ps

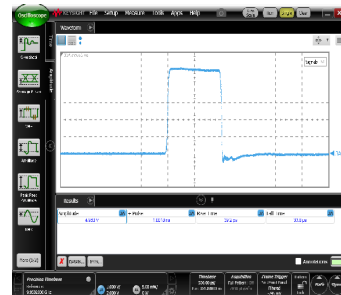

Output response: Pulse amplitude = 5 V_{pp}, Rise time = 32 ps

Low frequency repetition rate with a short pulse width of PW = 10 ns

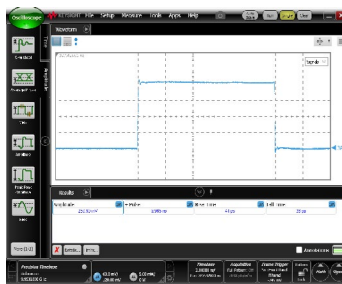

Input signal: Pulse amplitude = 0.25 V_{pp}, Rise time = 32 ps

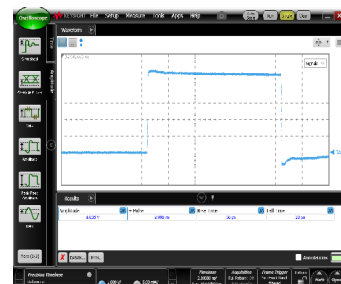

Output response: Pulse amplitude = 4.8 V_{pp}, Rise time = 32 ps



DRIVER | DR-PL-20-MO | 5/6
Electrical Schematic Diagram

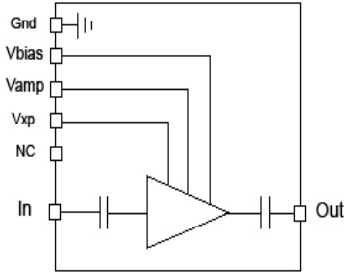

Mechanical Diagram and Pinout

All measurements in mm

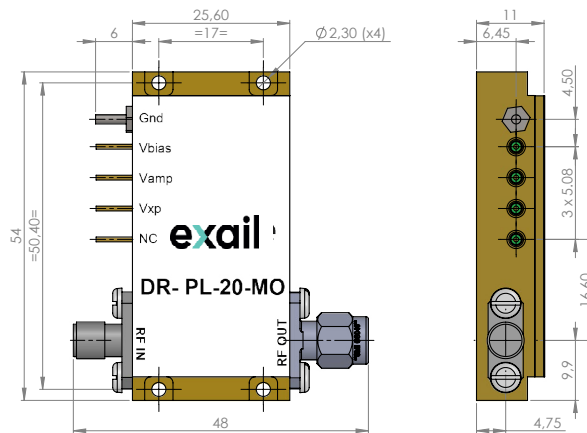

 The heat-sinking of the module is necessary. It's user responsibility to use an adequate heat-sink. Refer to page 6 for Exail recommended heat-sink.

PIN	Function	Operational Note
IN	RF In	Female K connector
OUT	RF Out	Male K connector
V_{bias}	Power supply voltage	Set a typical operating specification
V_{amp}	Output voltage amplitude adjustment	Adjust for gain control tuning
V_{xp}	Output pulse adjustment	Adjust for pulse adjustment (amplitude and width) tuning



DRIVER | **DR-PL-20-MO** | 6/6

Mechanical Diagram and Pinout with HS-MO2 Heat-sink

All measurements in mm

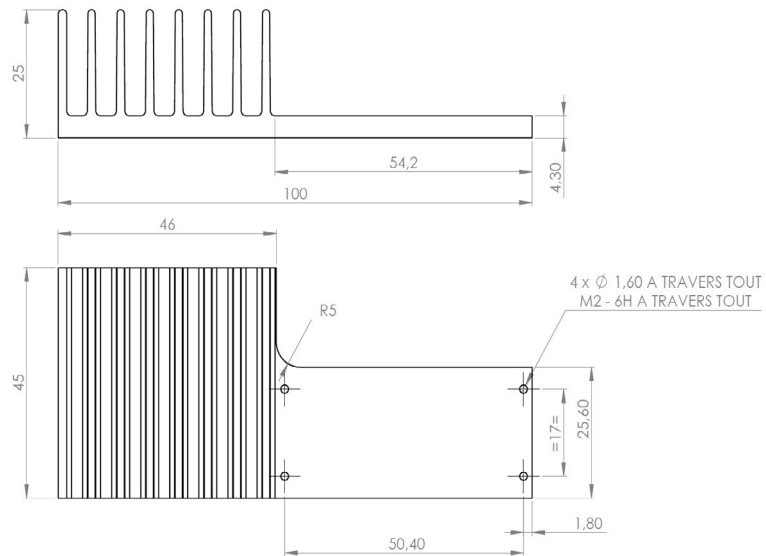
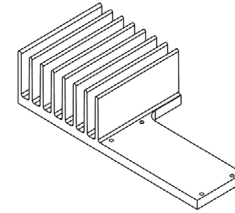

About us

Exail Photonics produces specialty optical fibers and Bragg gratings based fiber optics components and provides optical modulation solutions based on the company lithium niobate (LiNbO₃) modulators and RF electronic modules.

Exail Photonics serves a wide range of industries: sensing and instruments, defense, telecommunications, space and fiber lasers as well as research laboratories all over the world.

Exail reserves the right to change, at any time and without notice, the specifications, design, function or form of its products described herein. All statements, specification, technical information related to the products herein are given in good faith and based upon information believed to be reliable and accurate at the moment of printing. **However, Exail provides no warranty (whether express or implied or statutory) as to the description, sufficiency, accuracy or completeness, merchantability or fitness for a particular purpose of any information or specification detailed herein.** No liability is assumed for any inaccuracies and/or as a result of use of the products. The user must validate all parameters for each application before any use and he shall assume all risks and responsibilities in connection with the use of the products.



07_2023_ED5 / 00026998