

DRIVER

DR-DG-20-MO

20 Gbps NRZ/RZ High Performance Driver Module

The DR-DG-20-MO is a high performance versatile driver module designed for 2.5 Gbps up to 20 Gbps data transmission with NRZ or RZ format. It exhibits a 28 dB gain and can deliver an output signal up to $9 V_{pp}$.

The DR-DG-20-MO is a key component to obtain high quality 2.5 Gbps up to 20 Gbps eye diagrams with low rise and fall time, low jitter and high SNR. It operates from a single power supply for safety and ease of use, and offers gain and cross point controls. It comes with K type RF connectors (female in, male out) and with an optional heat-sink.



Features

- Output voltage up to $8 V_{pp}$
- Low Rise / Fall time
- Flat gain up to 20 GHz
- Single voltage power supply
- Low group delay variation

Applications

- LiNbO₃ modulators
- 20 Gbps NRZ and RZ
- Research & Development

Options

- Heat-sink

Performance Highlights

Parameter	Min	Typ	Max	Unit
Cut-off frequencies	50 k	-	18 G	Hz
Output voltage	2	-	8	V_{pp}
Gain	28	30	-	dB
Saturate output power	-	-	23	dBm
Added jitter	-	0.9	-	fs
Rise / Fall times	-	14	-	ps

Measurements for $V_{bias} = 12 V$, $V_{ctrl} = 0.65 V$, $V_{pp} = 1 V$, $I_{bias} = 319 mA$

20 Gbps Output Response

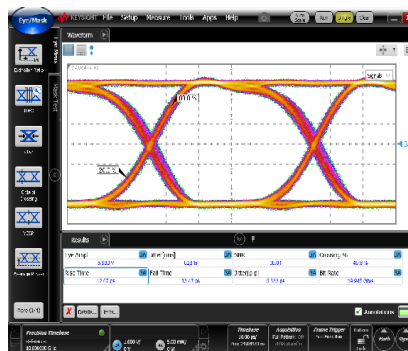

DRIVER | DR-DG-20-MO | 2/6

DR-DG-20-MO

20 Gbps NRZ/RZ High Performance Driver Module

DC Electrical Characteristics

Parameter	Symbol	Min	Typ	Max	Unit
Supply voltage (fixed)	V_{bias}	-	12	-	V
Current consumption	I_{bias}	-	260	-	mA
Gain control voltage	V_{amp}	-	0.5	-	V
Cross Point control voltage	V_{xp}	-	0.9	-	V

Electrical Characteristics

Parameter	Symbol	Condition	Min	Typ	Max	Unit
Lower frequency	$f_{3db, lower}$	-3 dB point	-	-	50	kHz
Upper frequency	$f_{3db, upper}$	-3 dB point	18	20	-	GHz
Gain	S_{21}	Small signal	28	30	-	dB
Gain ripple	-	$f < 15$ GHz	-	± 1.5	-	dB
Input return loss	S_{11}	$10 \text{ MHz} < f < 12 \text{ GHz}$	-	-10	-	dB
Output return loss	S_{22}	$10 \text{ MHz} < f < 15 \text{ GHz}$	-	-10	-	dB
Saturated output power	P_{sat}	$V_{in} = 0.5 V_{pp}$	22	23	-	dBm
Output voltage	V_{out}	$V_{in} = 0.5 V_{pp}$	2	-	8	V_{pp}
Rise / Fall time	t_r / t_f	20 % - 80 %	-	12 / 16	-	ps
Added Jitter	J_{RMS}	$J_{RMS} = \sqrt{J_{RMS-total}^2 - J_{RMS-source}^2}$	-	0.9	-	ps
Noise figure	NF	$1 \text{ GHz} < f < 20 \text{ GHz}$	3.5	-	6	dB
Power dissipation	P	$V_{out} = 8 V_{pp}$	-	3.2	-	W

Conditions: $V_{in} = 0.5 V_{pp}$, $T_{amb} = 25^\circ\text{C}$, 50 W system**Absolute Maximum Ratings**

Stresses in excess of the absolute maximum ratings can cause permanent damage to the device. These are absolute stress ratings only. Functional operation of the device is not implied at these or any other conditions in excess of those given in the operational sections of the data sheet. Exposure to absolute maximum ratings for extended periods can adversely affect device reliability.

Parameter	Symbol	Min	Max	Unit
RF input voltage	V_{in}	-	1	V_{pp}
Supply voltage	V_{bias}	11	13	V
DC current	I_{bias}	0	0.4	A
Gain control voltage	V_{amp}	0	1.2	V
Cross Point control voltage	V_{xp}	0	1.1	V_{pp}
Power dissipation	P_{diss}	-	5.2	W
Operating temperature	T_{op}	0	+40	$^\circ\text{C}$
Storage temperature	T_{st}	-20	+70	$^\circ\text{C}$



DRIVER | DR-DG-20-MO | 3/6

DR-DG-20-MO

S_{21} and Group Delay Parameter Curves

Conditions: $V_{bias} = 12\text{ V}$, $V_{amp} = 0.65\text{ V}$, $V_{xp} = 1\text{ V}$, $I_{bias} = 319\text{ mA}$

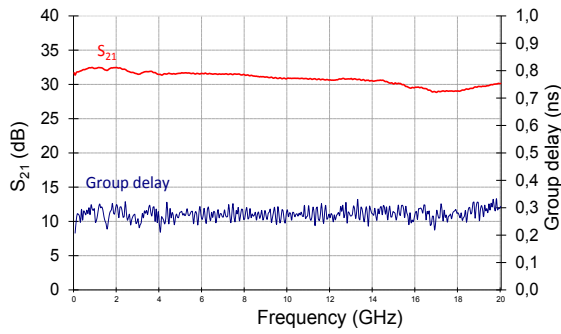

S_{12} Parameter Curve

Conditions: $V_{bias} = 12\text{ V}$, $V_{amp} = 0.65\text{ V}$, $V_{xp} = 1\text{ V}$, $I_{bias} = 319\text{ mA}$

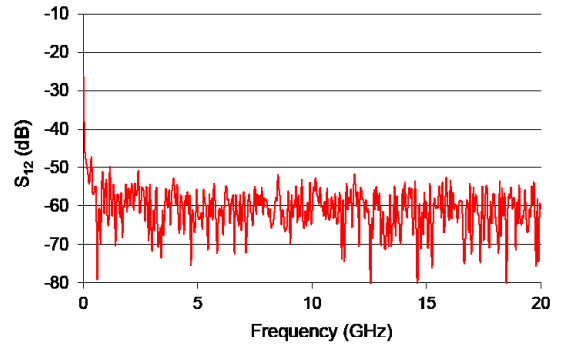

S_{22} Parameter Curve

Conditions: $V_{bias} = 12\text{ V}$, $V_{amp} = 0.65\text{ V}$, $V_{xp} = 1\text{ V}$, $I_{bias} = 319\text{ mA}$

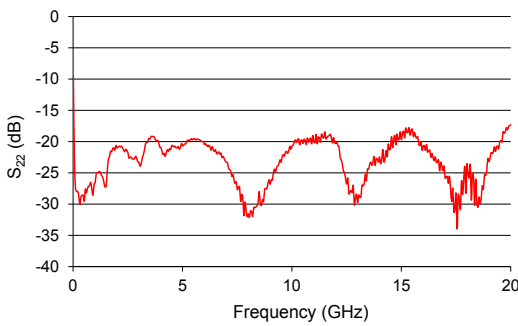

S_{11} Parameter Curve

Conditions: $V_{bias} = 12\text{ V}$, $V_{amp} = 0.65\text{ V}$, $V_{xp} = 1\text{ V}$, $I_{bias} = 319\text{ mA}$

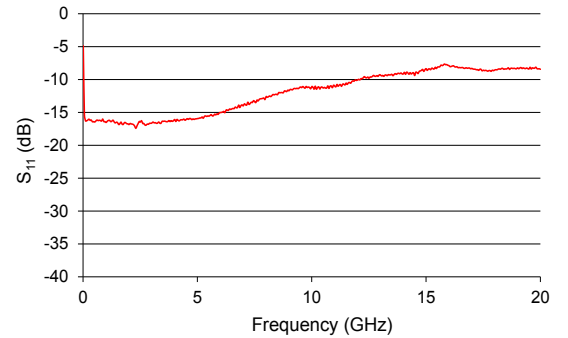

Typical Output Voltage Amplitude vs V_{amp}

Conditions: $V_{bias} = 12\text{ V}$, $V_{in} = 0.5\text{ V}$

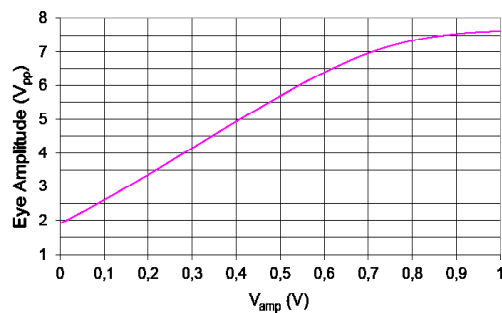

Typical Cross point vs V_{xp}

Conditions: $V_{bias} = 12\text{ V}$, $V_{in} = 0.5\text{ V}$

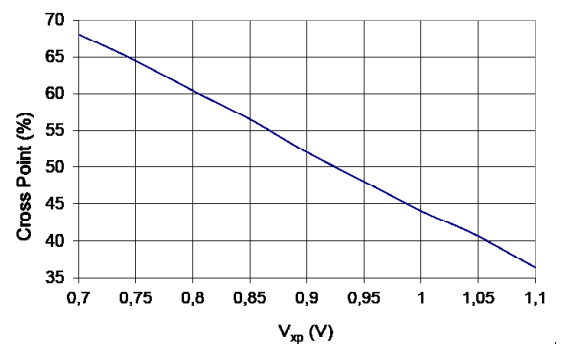

DRIVER | DR-DG-20-MO | 4/6

DR-DG-20-MO

Eye Diagrams

12.5 Gbps data rate

Conditions: Ratio 1/2, Pattern 2³¹-1

$V_{bias} = 12\text{ V}$, $V_{amp} = 0.75\text{ V}$, $V_{xp} = 0.88\text{ V}$, $I_{bias} = 277\text{ mA}$



Input signal
Eye amplitude = 0.45 V_{pp}

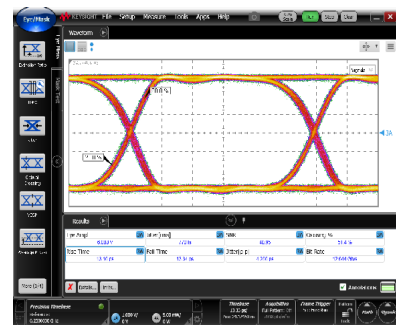

Output response
Eye amplitude = 6 V_{pp}

20 Gbps data rate

Conditions: Ratio 1/2, Pattern 231-1

$V_{bias} = 12\text{ V}$, $V_{amp} = 0.65\text{ V}$, $V_{xp} = 1\text{ V}$, $I_{bias} = 319\text{ mA}$

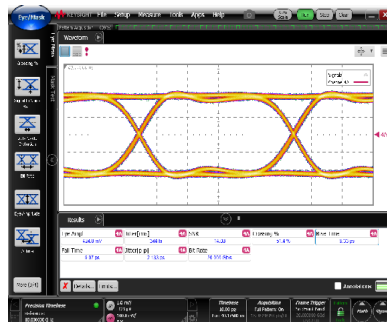

Input signal
Eye amplitude = 0.43 V_{pp}

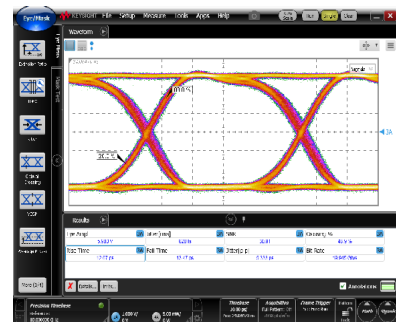

Output response
Eye amplitude = 6 V_{pp}



DRIVER | **DR-DG-20-MO** | 5/6
Electrical Schematic Diagram

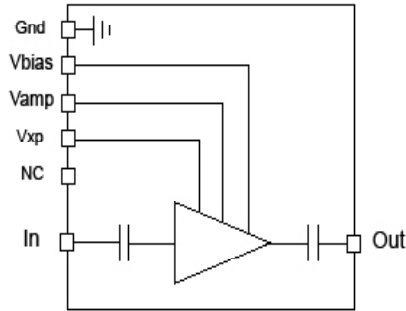

Mechanical Diagram and Pinout

All measurements in mm

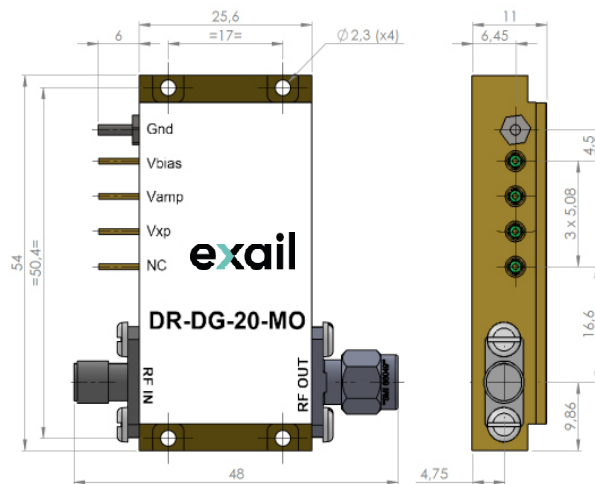

The heat-sinking of the module is necessary. It's user responsibility to use an adequate heat-sink. Refer to page 6 for Exail recommended heat-sink.

Port	Function	Unit
IN	RF In	Female K connector
OUT	RF Out	Male K connector
V_{bias}	Power supply voltage	Set a typical operating specification
V_{amp}	Output voltage amplitude adjustment	Adjust for gain control tuning
V_{amp}	Output voltage cross point adjustment	Adjust for cross point control tuning

exail

DRIVER | **DR-DG-20-MO** | 6/6

Mechanical Diagram and Pinout with HS-MO2 Heat-sink

All measurements in mm

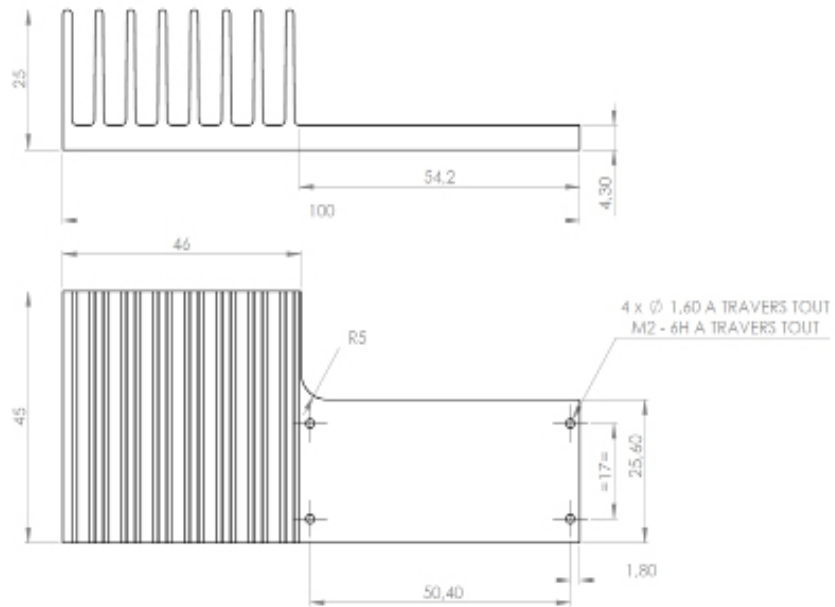
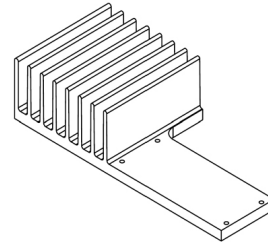

About us

Exail Photonics produces specialty optical fibers and Bragg gratings based fiber optics components and provides optical modulation solutions based on the company lithium niobate (LiNbO₃) modulators and RF electronic modules.

Exail Photonics serves a wide range of industries: sensing and instruments, defense, telecommunications, space and fiber lasers as well as research laboratories all over the world.

Exail reserves the right to change, at any time and without notice, the specifications, design, function or form of its products described herein. All statements, specification, technical information related to the products herein are given in good faith and based upon information believed to be reliable and accurate at the moment of printing. **However, Exail provides no warranty (whether express or implied or statutory) as to the description, sufficiency, accuracy or completeness, merchantability or fitness for a particular purpose of any information or specification detailed herein.** No liability is assumed for any inaccuracies and/or as a result of use of the products. The user must validate all parameters for each application before any use and he **shall** assume all risks and responsibilities in connection with the use of the products.



01_2023_ED6/00024989