

Evaluation Board for SPC-PSD

Evaluation board for SiTek Position Sensing Detector with Signal Processing Circuit

Part number: SE – 0012

Description: Evaluation board SPC01

The Evaluation Board for SPC01 is a tool for simplifying the evaluation of our SPC-PSDs. The board includes offset compensation electronics and a 14-pin connector that makes the inputs and outputs of the SPC-PSD easily accessible.

The Evaluation Board can easily be mounted on an optical table by using a standard 2" filter holder or screwed to for example an XYZ stage by using M6 screws.

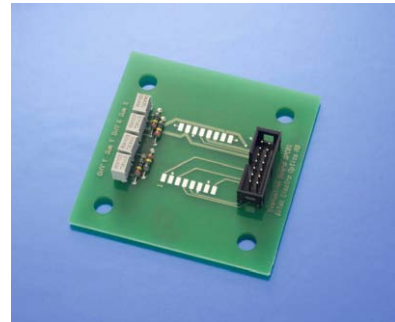

Electrical specification

Parameter	Symbol	Value	Unit
Potentiometers	P_1-P_4	10	k Ω
Offset compensation resistors	R_1-R_4	1	M Ω
Offset compensation range		± 295	mV

Absolute maximum ratings

Parameter	Symbol	Value	Unit
Power supply voltage	V_s	± 18	V

Offset compensation range

The range of the offset compensation is determined by the value of the the offset compensation resistors. This range can be changed by replacing the resistors R1-R4 with other resistors.

Resistor value (R1-R4)	Offset compensation range
5 Mohm	± 60 mV
500 kohm	$\pm 0,58$ V
100 kohm	$\pm 2,5$ V

Connector Description

Pin no.	Input/Output	Information
1	+15 V	
2	Gnd	
3	-15 V	
4	N.A.	No connection
5	N.A.	No connection
6	N.A.	No connection
7	Amp Y1	
8	Amp Y2	
9	Diff Y	Amp Y1 – Amp Y2
10	Sum Y	Amp Y1 + Amp Y2
11	Amp X1	
12	Amp X2	
13	Diff X	Amp X1 – Amp X2
14	Sum X	Amp X1 + Amp X2

Connector type:
Low profile 14-pin header
2,54 x 2,54 mm Centerline, matrix

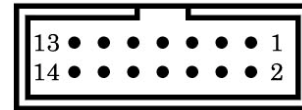

Schematics

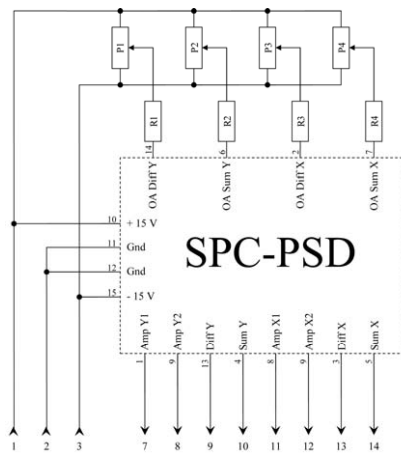

Dimensions

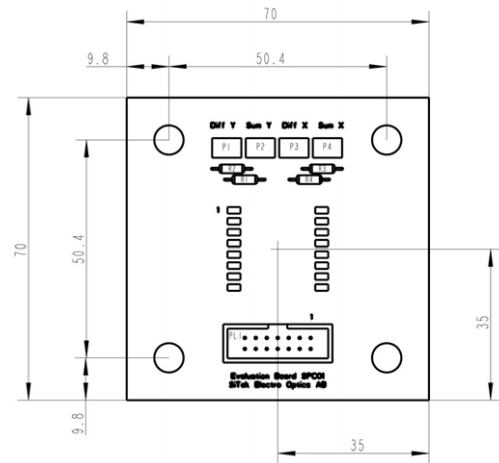

Solder instructions

Soldering of the SPC-PSD to the Evaluation Board shall be done by soldering iron within the specification below.

Maximum power	30 W
Maximum temperature at tip of iron	300 °C
Maximum soldering time	5 s

Information in this data sheet is believed to be reliable. However, no responsibility is assumed for possible inaccuracies or omissions. Specifications are subjected to changes without notice.