

Data Sheet

Photon Wave UV LED SOLUTION

1. Features

- Light Source for Sterilization and Medical Application
- Lighting Color(Peak Wavelength) : 265nm
- Surface Mount Type LED: 3.5 x 3.5 x 1.55(L x W x H)[Unit : mm]
- Soldering Methods: Reflow Soldering

2. Outline Dimension

Notes : All dimensions are in millimeter and tolerance is $\pm 0.2\text{mm}$ unless otherwise noted

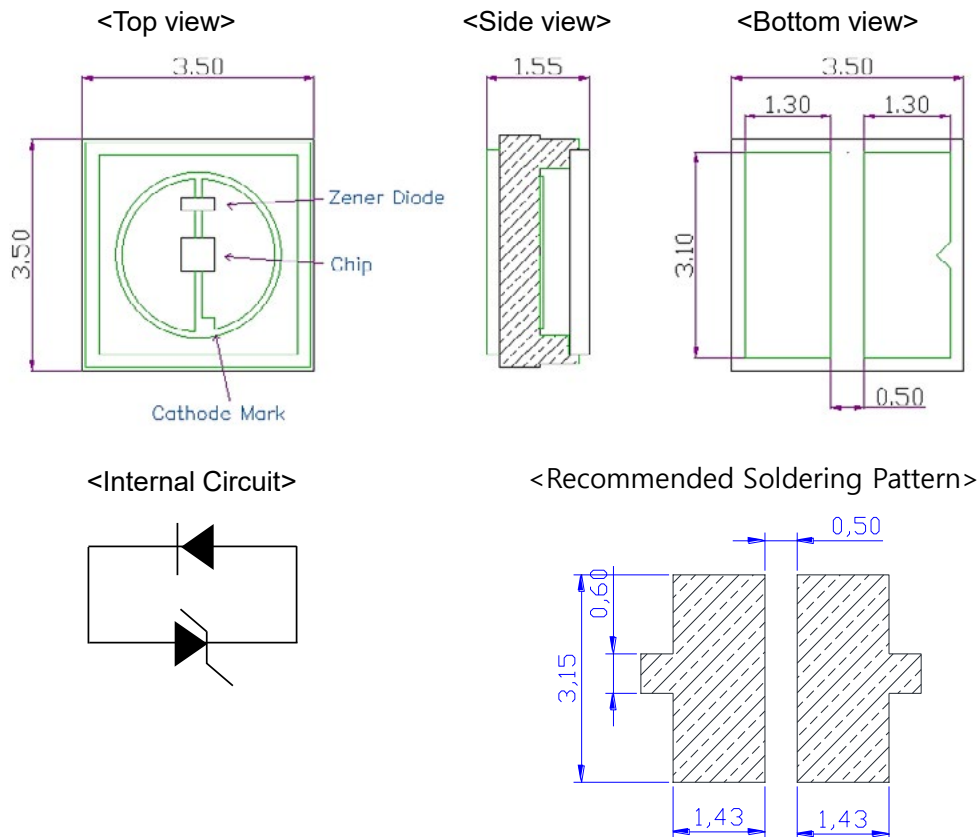

Rev0.0, 30th, March, 2021

Data Sheet

Photon Wave UV LED SOLUTION

3. Application

- Disinfection, Phototherapy, Fluorescent Spectroscopy, Sensor Light, Bio-Analysis / Direction, Counterfeit Detector etc.

4. Absolute Maximum Ratings ($T_a = 25\text{ }^\circ\text{C}$)

Parameters	Symbol	Ratings	Unit
Power Dissipation	P_d	5.11	W
Forward Current	I_F	700	mA
Operating Temperature	T_{opr}	-30 ~ +60	$^\circ\text{C}$
Storage Temperature	T_{stg}	-40 ~ +100	$^\circ\text{C}$
Junction Temperature	T_j	100	$^\circ\text{C}$
Soldering Temperature	JEDEC-J-STD-020D		
ESD Classification	Class 2(ANSI / ESDA / JEDEC JS-001)		

Notes :

- Operating the LED beyond the listed maximum ratings may affect device reliability and cause permanent damage. These or any other conditions beyond those indicated under recommended operating conditions are not implied. The exposure to the absolute maximum rated conditions may affect device reliability.
- The LEDs are not designed to be driven in reverse bias.

Rev0.0, 30th, March, 2021

Data Sheet

Photon Wave UV LED SOLUTION

5. Electro-Optical Characteristics ($I_F = 500 \text{ mA}$, $T_a = 25 \text{ }^\circ\text{C}$) ^{Note 1}

Parameters	Symbol	Spec			Unit
		Min	Typ	Max	
Forward Voltage	V_f	5.0	6.5	7.0	V
Radiant Flux	P_o	-	85.0	-	mW
Peak Wavelength	λ_p	260	265	270	nm
Spectrum Half Width	$\Delta\lambda$	-	12	-	nm
Viewing Angle	$2\Theta_{1/2}$	-	120	-	deg
Thermal Resistance ^{Note 2} (Junction to Solder point)	R_{thJ-S}	-	11	-	$^\circ\text{C/W}$

Notes :

- Measured by optical spectrum analyzer of Photon Wave, some values may vary depending on the conditions of the test equipment.
 - Forward Voltage (V_f) : $\pm 0.1\text{V}$
 - Peak Wavelength (λ_p) : $\pm 3\text{nm}$
 - Radiant Flux (P_o) : $\pm 10\%$
- Thermal resistance can be increased substantially depending on the heat sink design/operating condition, and the maximum possible driving current will decrease accordingly.

Rev0.0, 30th, March, 2021

Data Sheet

Photon Wave UV LED SOLUTION

6. Characteristic Curves ($T_a = 25\text{ }^\circ\text{C}$)

< Forward Voltage vs. Forward Current >

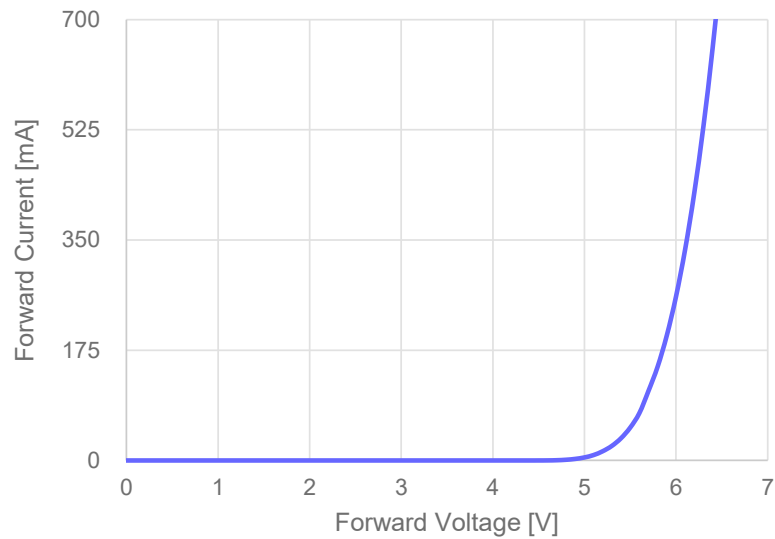

< Forward Current vs. Relative Radiant Flux >

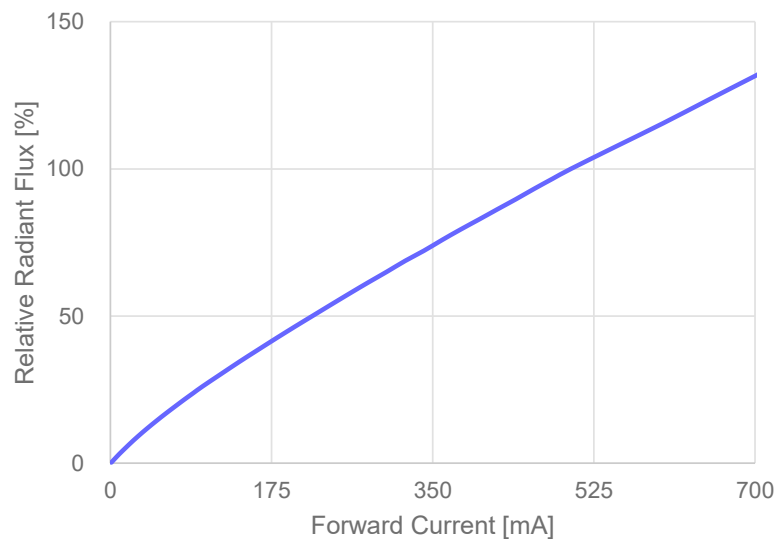

Rev0.0, 30th, March, 2021

Data Sheet

Photon Wave UV LED SOLUTION

6. Characteristic Curves ($T_a = 25\text{ }^\circ\text{C}$)

< Spectrum, $I_F = 500\text{ mA}$ >

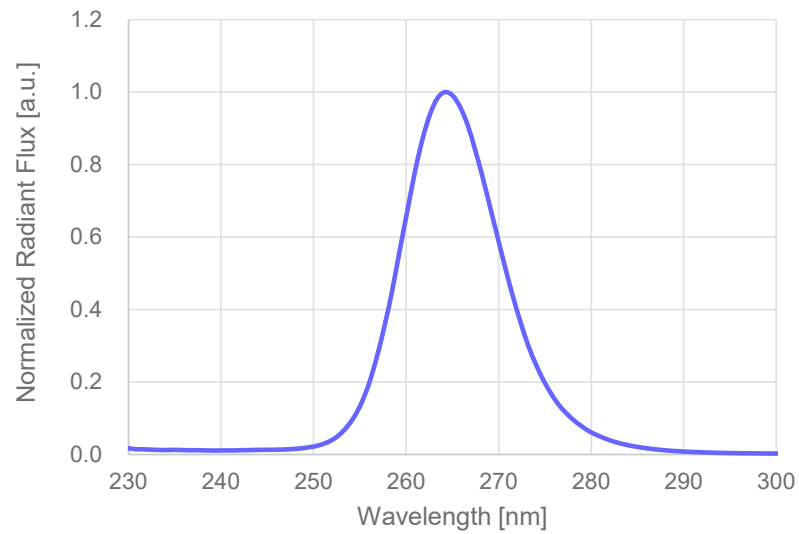

< Forward Current vs. Peak Wavelength >

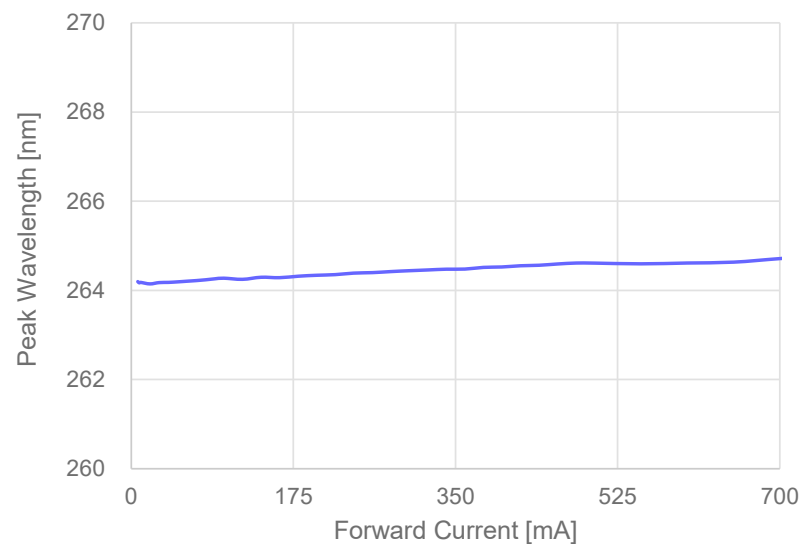

Rev0.0, 30th, March, 2021

Data Sheet

Photon Wave UV LED SOLUTION

6. Characteristic Curves ($I_F = 500 \text{ mA}$, $T_a = 25 \text{ }^\circ\text{C}$)

< Ambient Temperature vs. Relative Radiant flux >

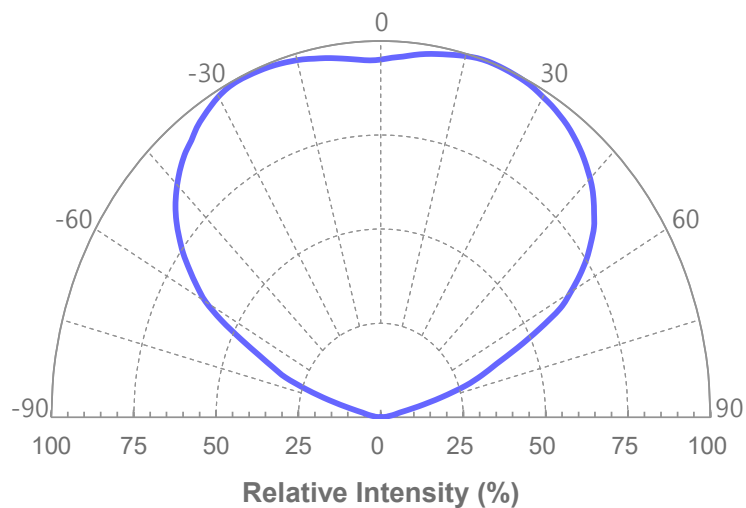
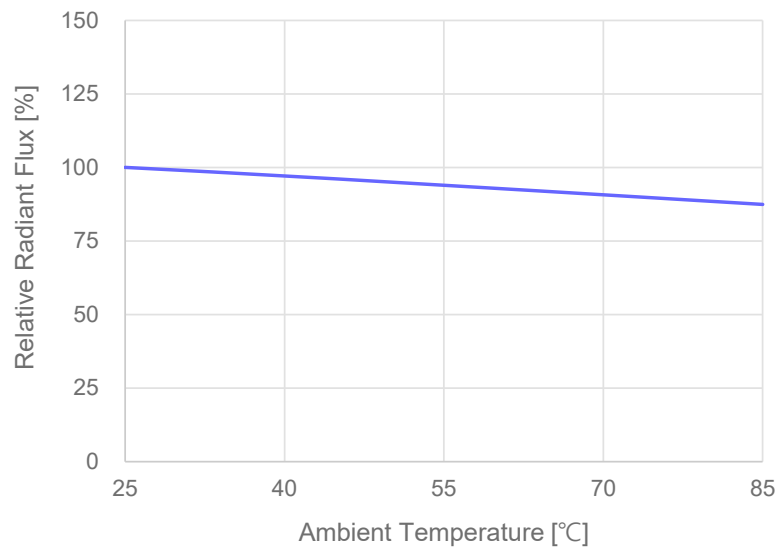

Rev0.0, 30th, March, 2021

Data Sheet

Photon Wave UV LED SOLUTION

7. Reliability Test Items and Conditions

7-1. Failure Criteria

Items	Symbols	Test Conditions	Criteria	
			Min.	Max.
Forward Voltage	V _f	IF = 500mA	-	Initial Value X 1.1
Radiant Flux	Φ _e	IF = 500mA	Initial Value X 0.7	-

7-2. Reliability Tests

No	Items	Test Conditions	Test Hours / Cycles	# Failed / Tested
1	Room Temp. Operating Life [RTOL]	T _a = 25°C, I _f = 500mA	1000 Hours	0 / 5
2	Wet High Temp. Operating Life [WHTOL]	T _a = 60°C, 90% RH, I _f = 500mA	1000 Hours	0 / 5
3	High Temp. Storage Life [HTSL]	T _a = 100°C	1000 Hours	0 / 5
4	Low Temp. Storage Life [LTSL]	T _a = -40°C	1000 Hours	0 / 5
5	Thermal Shock	T _a max = 125°C, T _a min = -45°C each 15min	100 cycles	0 / 10
6	Resistance to Solder Heat	(Pre-store @ 60°C, 90±5% RH for 168hrs) Temp = 260±5°C, Time ; 10±1 sec	2 times	0 / 10
7	Vibration variable frequency	0.06 inch displacement, 20 to 100 Hz 50 g, 100 Hz to 2kHz	X, Y, Z axis total 2hours	0 / 10
8	ESD	R = 1.5kΩ, C = 100pF Voltage level = 2kV	± 3 times	0 / 22

Notes :

- All samples are tested using Photon Wave Standard Metal PCB(25X25X1.6mm(LxWxH)) except non-operating tests.
- All samples must pass each test item and all test items must be satisfied.

Rev0.0, 30th, March, 2021

Data Sheet

Photon Wave UV LED SOLUTION

8. Packing and Labelling of Product

8-1. Taping Outline Dimensions

* Reel

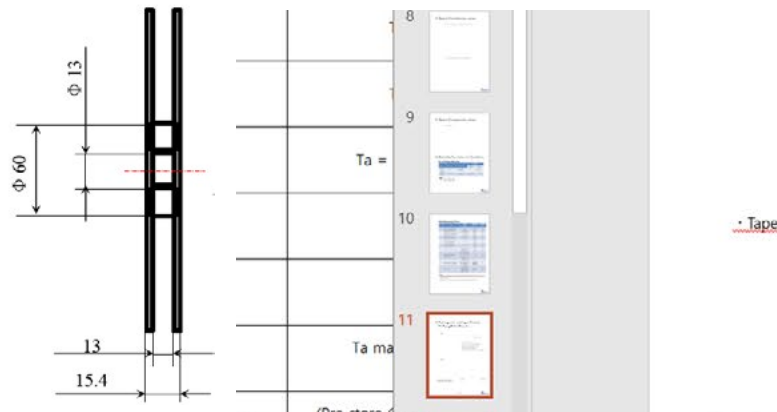

* Tape

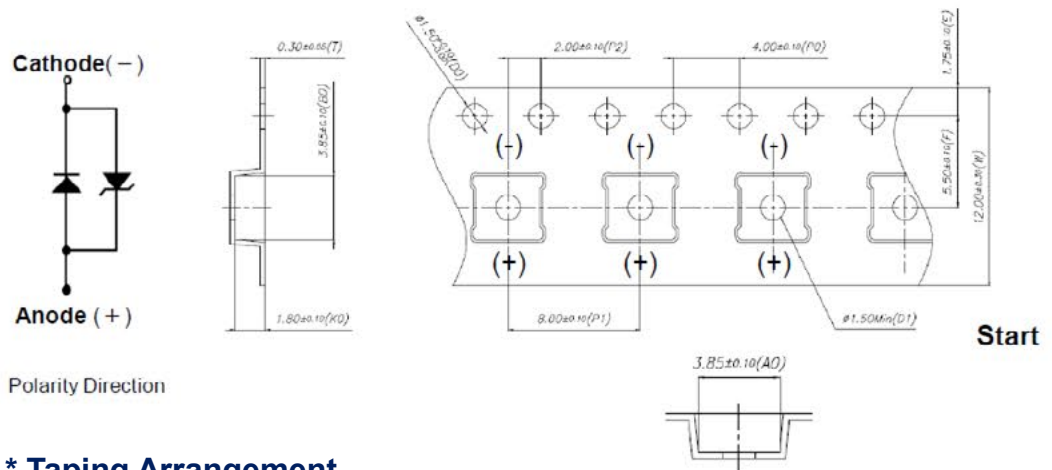

* Taping Arrangement

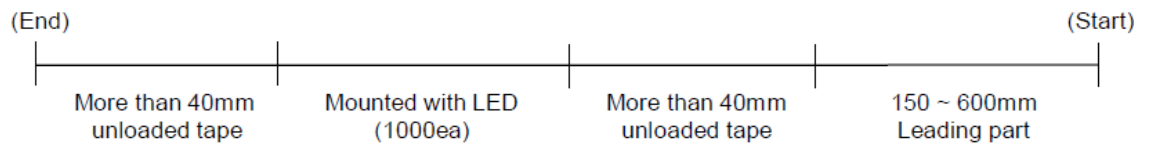

Rev0.0, 30th, March, 2021

Data Sheet

Photon Wave UV LED SOLUTION

8. Packing and Labelling of Product

8-2. Package and Label Structure

* Label A

Specifying Model Name, Rank, Rack, Quantity and Run number

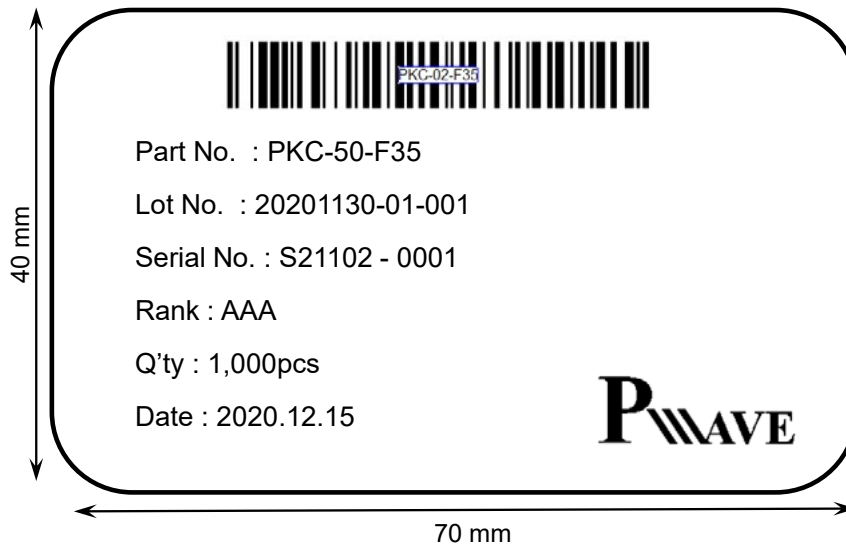

* Lot No. Indication

Lot No. : 20201130 - 01 - 001
 year/month/day Bin No. Reel no.

Rank : $\frac{A}{Pw}$ $\frac{A}{Power}$ $\frac{A}{VF}$

Rev0.0, 30th, March, 2021

Data Sheet

Photon Wave UV LED SOLUTION

8. Packing and Labelling of Product

8-2. Package and Label Structure

* Label B

Specifying Customer, Date, Model Name, Quantity, Customer Part Number, Outbox ID, Rank/Rank Quantity

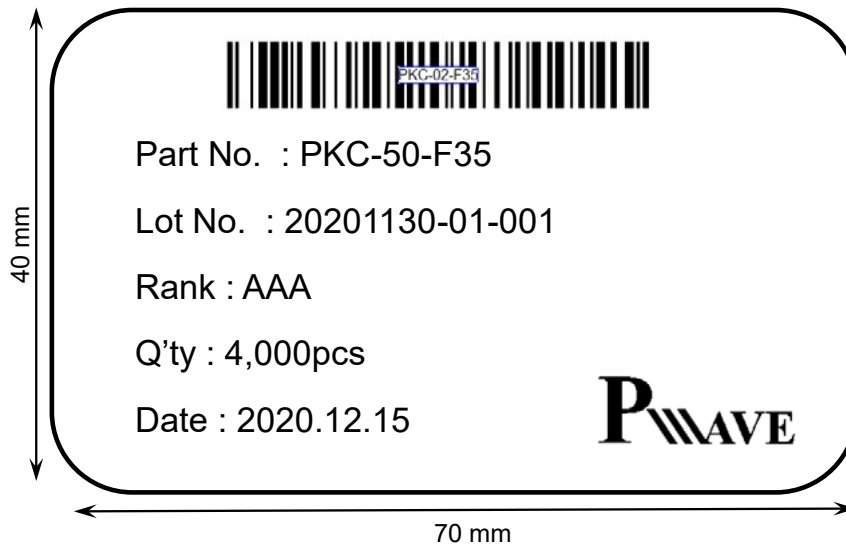

* Lot No. Indication

Lot No. : 20201130 - 01 - 001
 year/month/day Bin No. Reel no.

Rank : $\frac{A}{Pw}$ $\frac{A}{Power}$ $\frac{A}{VF}$

Rev0.0, 30th, March, 2021

Data Sheet

Photon Wave UV LED SOLUTION

8. Packing and Labelling of Product

8-3. Packing Specifications

Reeled products (Numbers of products are Max.1,000pcs) packed in a sealed-off and moisture-proof aluminum bag with desiccants (Silica Gel). A Maximum four aluminum bags are packed in an inner box and six inner boxes are packed in an outer box. (Total Max. number of products are 24,000pcs)

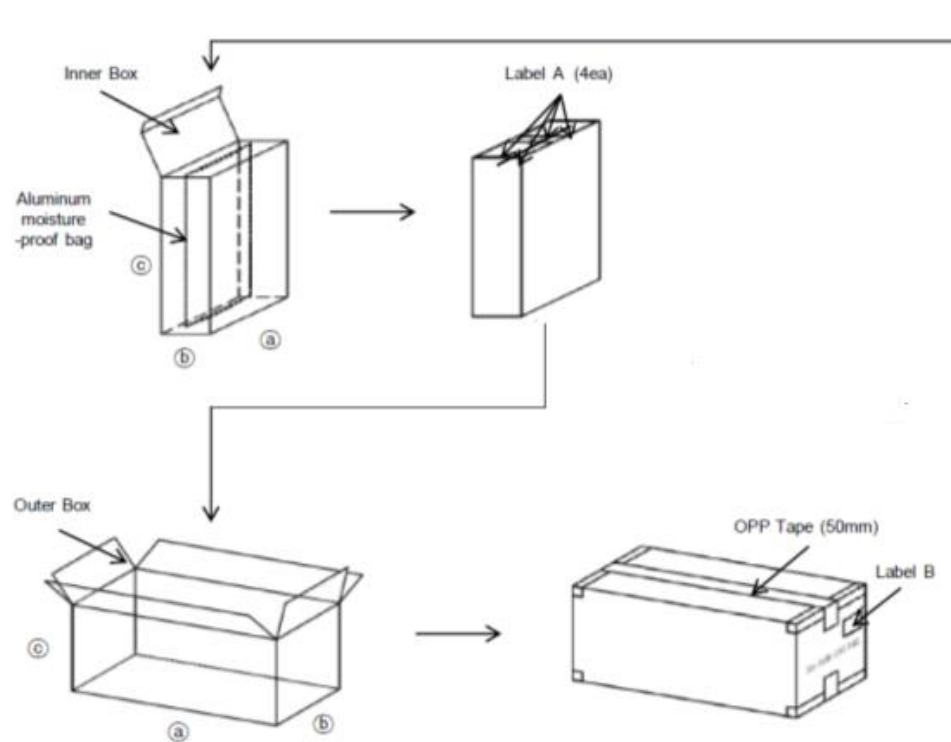

Notes:

- Reeled products (number of products is max 1,000pcs) packed in a sealed aluminum bag.
- A maximum 4 bags are packed in an inner box. (Total max number of products is 4,000pcs)
- A maximum 4 inner boxes are packed in an outer box. (Total max number of products is 24,000pcs)

Types	Sizes (mm)		
	a	b	c
Inner Box	227	82	258
Outer Box	530	240	280

Rev0.0, 30th, March, 2021

Data Sheet

Photon Wave UV LED SOLUTION

9. Guide for User

9-1. Soldering Condition

- Reflow Soldering is the recommended method for assembling LEDs on a circuit board.
- Photon Wave does not guarantee the performance of the LEDs assembled by the dip soldering method.
- Recommended Soldering Profile(According to JEDEC J-STD-020D)
- Reflow or hand soldering at the lowest possible temperature is desirable for the LEDs although the recommended soldering conditions are specified in the below diagrams.
- A rapid-rate process is not recommended for cooling the LEDs down from the peak temperature.
- Occasionally there is a brightness decrease caused by the influence of heat of ambient atmosphere during air reflow. It is recommended that the customer use the nitrogen reflow method.
- Glass plate is hermetic sealed on the LEDs. Therefore, the LEDs have a soft and very fragile surface on the top of the package.
- The pressure to the surface will be influence to the reliability of the LEDs. Precautions should be taken to avoid strong pressure on the silicone resin when leveraging the pick and place machines.
- Reflow soldering should not be done more than two times.
- Soldering Iron
 - The recommended condition is less than 5 sec at 260 °C.
 - The time must be shorter for higher temperatures(+10 °C → -1 sec).
 - The power dissipation of the soldering iron should be lower than 15 W and the surface temperature of the device should be controlled at or under 230 °C.

Rev0.0, 30th, March, 2021

Data Sheet

Photon Wave UV LED SOLUTION

9. Guide for User

9-1. Soldering Condition

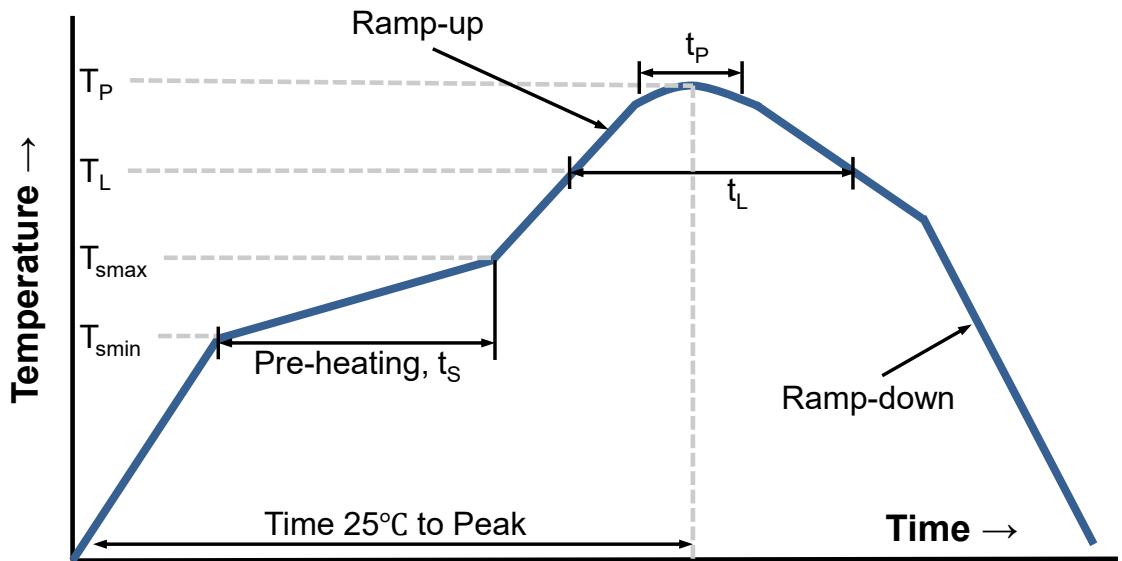

Profile Feature	Lead Free Assembly
Average Ramp-up Rate (T_{smax} to T_P)	3 °C / sec Max
Preheating Temperature Min (T_{smin})	150 °C
Preheating Temperature Max (T_{smax})	200 °C
Preheating Time (T_s , T_{smin} to T_{smax})	60 ~ 180 sec
Time Maintained Above Temperature (T_L)	217 °C
Time Maintained Above Time (t_L)	60 ~ 150 sec
Peak / Classification Temperature (T_P)	260 °C
Time Within 5°C of Actual Peak Temperature (t_p)	5 sec
Ramp-down Rate	6 °C / sec Max
Time 25°C to Peak Temperature	8 min Max

Rev0.0, 30th, March, 2021

Data Sheet

Photon Wave UV LED SOLUTION

9. Guide for User

9-2. Recommended Solder Pattern

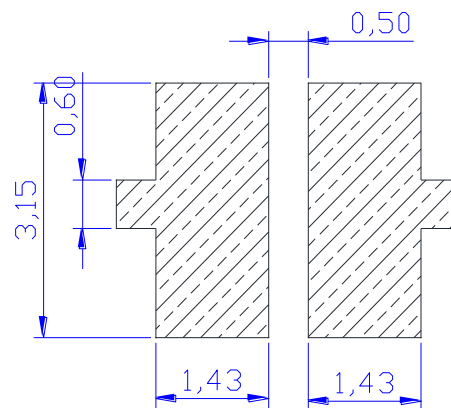

Notes:

1. All dimensions are in millimeter and tolerance is $\pm 0.2\text{mm}$ unless otherwise noted.
2. Photon Wave does not guarantee the performance of the LEDs which have been already assembled using the dip soldering method.
3. There is a radiant flux decrease caused by the influence of heat of ambient atmosphere under air reflow condition. We recommend to use the nitrogen reflow method.
4. Reflow soldering should not be done more than two times.

Rev0.0, 30th, March, 2021

Data Sheet

Photon Wave UV LED SOLUTION

9. Guide for User

9-3. Cautions on Use

Eye Safety Guidelines

- Do not view directly at the UV light of LED or optical instrument because it is harmful to human eyes.
- Do not expose to the human body and eyes during the LED light because UV light can be hazardous for human
- Please wear UV protective products such as UV protective glasses, mask and so on.

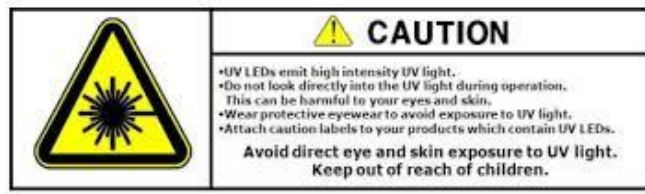
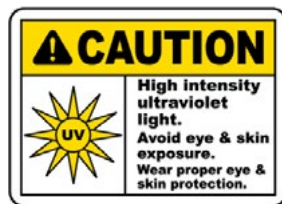

Static Electricity

- Wristbands and anti-electrostatic gloves are strongly recommended and all devices, equipment and machinery must be properly grounded when handling the LEDs, which are sensitive against static electricity and surge.
- Precautions are to be taken against surge voltage to the equipment that mounts the LEDs.
- Unusual characteristics such as significant increase of current leakage, decrease of turn-on voltage, or non-operation at a low current can occur when the LED is damaged.

Manual Handling

- Minimize contact between metallic fixtures, tweezers, or other hard objects and the emitting surface. The pressure to the surface can damage the junction and lead to increased leakage current as a consequence.
- If possible, avoid the use of tapes or adhesives to the emitting surface which is subject to be contaminated by tape residue. Contaminated surface leads to reduced light extraction.
- Rubber collets are strongly recommended during the die pick and place process. Harder plastic collets may also be used with minimized die bonding parameters (bonding pressure).

Rev0.0, 30th, March, 2021

Data Sheet

Photon Wave UV LED SOLUTION

Recommended Drive Circuits

- The parallel circuit design with a single resistor can result in different forward current to each LED, which means the LED shows an unexpected output performance. In the worst case, the currents can exceed the absolute maximum ratings which can stress the LEDs. So, we strongly recommend that a current limiting resistor be applied in the drive circuit, in series with each LED.
- Reverse voltage can damage the Zener diode and cause destructions.

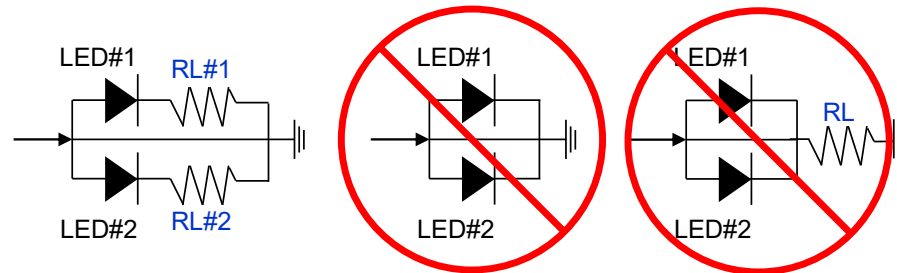

Storage Environment

- The storage location should be kept at normal temperature and humidity, that is 25 to 35 °C and 45 to 70 % relative humidity. Care must be taken to avoid storage under temperature and humidity conditions that are significantly different from these.
- Avoid storage in a location with corrosive gas or a large amount of dust.
- Sudden temperature variations can cause condensation to form on devices and/or packaging material, so avoid such an environment.
- Store devices in a location with free of radiation, static electricity and strong electro-magnetic fields.

Rev0.0, 30th, March, 2021

Data Sheet

Photon Wave UV LED SOLUTION

Cleaning

- Do not use brushes for cleaning or organic solvents(i.e. Acetone, TCE etc) for washing as they may damage the resin of the LEDs.
- Isopropyl Alcohol(IPA) solvent is the recommended for cleaning the LEDs under the following conditions.
- Cleaning Condition : IPA, 25°C max. x 60sec max.
- Ultrasonic cleaning is not recommended.
- Excessive N2 / Air blowing is not advised. Physical stress during blowing can cause the glass to separate from the package.
- Pre-tests should be conducted with the actual cleaning process to validate that the process will not damage the LEDs.

Rev0.0, 30th, March, 2021

Data Sheet

Photon Wave UV LED SOLUTION

During Usage

- The moisture in the SMD package may vaporize and expand during soldering.
- The moisture can damage the optical and electrical characteristics of the LEDs affecting resin.
- (Extreme environments such as sudden ambient temperature changes or high humidity that can cause condensation must be avoided.) The LEDs should be necessary to prevent water moisture and salt damage.
- The metal parts(including silver plated metal) on the LED can rust when exposed to corrosive gases.
- Therefore, exposure to corrosive gases must be avoided during operation and storage.
- The metal parts(including silver plated metal) also can be affected not only by the corrosive gases emitted inside of the end-products but by the gases penetrated from outside environment.
- The LED should be avoided direct or indirect(All forms of gas, fume, vapor form etc) contact with hazardous materials such as sulfur, chlorine, phthalate, acid, solvent etc. These materials(S, Cl, VOCs, acid etc.) may cause sulfurization of silver lead-frame or encapsulant silicone discoloration in LED.
- VOCs(Volatile Organic Compounds) can be generated from adhesives glue, cleaning flux, molding hardener or organic additive which used in luminaires fixtures and they(VOCs) may cause a significant radiant flux degradation of LED in luminaires when they exposed to heat or light.
- To prevent this phenomenon, materials used in luminaires must be carefully selected by users.

Rev0.0, 30th, March, 2021

Data Sheet

Photon Wave UV LED SOLUTION

Thermal Management

- The thermal design of the end product must be seriously considered, particularly at the beginning of the system design process.
- The generation of heat is greatly impacted by the input power, the thermal resistance of the circuit boards and the density of the LED array combined with other components.

Others

- Photon Wave will not be held responsible for any damage to the user that may result from accidents, including, without limitation, (i) operation of the user's unit that exceed the absolute maximum rations and/or (ii) not complying with various matters, precautions, or guidelines that demand special attention.
- When defective LEDs are found, the customer shall inform Photon Wave.
- The customer shall not reverse engineer by disassembling or analyzing the LEDs without having prior written consent from Photon Wave.
- The appearance and specification of LEDs may be modified for improvement without notice. However, Photon Wave shall not be responsible for any damage that may result from such improvement.

Rev0.0, 30th, March, 2021

Data Sheet

Photon Wave UV LED SOLUTION

Disclaimer

- The customer shall at its own risk, cost and expense obtain from any applicable international standard institution, country, governmental authority or agency any and all approvals, permits, licenses, standards and/or other requirements (collectively 'approvals')(including, without limitation, type approval, ISO, IEC (including 62471, 62778), ACGIH AND ICNIRP) associated with or related to the design, manufacture, use, sale, offer for sale or other disposal of (i) the LEDs and/or (ii) the customer's products incorporating the LEDs("subjected products"), which are required under the applicable laws, rules, regulations, or orders of the countries that the subjected products are manufactured, imported, used, sold or disposed of.
- Photon Wave shall not be responsible for any and all claims or issues arising out of, relating to, resulting from or in connection with the customer's breach, violation or non-compliance of obligations set forth above. The customers shall defend, hold harmless and indemnify, Photon Wave, its officers, vendors, subcontractors and all their respective directors, officers, employees, agents, customers and distributors from and against any and all claims, suits, actions, proceedings, damages, losses, liabilities, fines, penalties, costs and expenses that are arisen out of or resulted from (i)failure or violation of obtaining the approvals; (ii) the customer's modifications of and/or additions to the subjected products; (iii) the customer's misuse or abuse of the subjected products; and/or (iv) failure of the customer to abide by all applicable laws, rules, regulations and/or orders that affect the subjected products.

Rev0.0, 30th, March, 2021

