

Drive Electronics for Pulsed Laser Diodes Power where it Matters

Winfried Reeb, Laser Components GmbH, Olching

In portable optoelectronic measurement technology laser sources are getting smaller and more affordable in areas such as distance and speed measurement, laser scanners, and medical and military technology. Suitable drive electronics are required for high-power or pulsed laser diodes – being the heart of the emitter – to deliver an optimal performance.

It should have been a successful product presentation. When the big potential client pushed the button on the laser rangefinder, however, no measurement was taken and the display remained dark. As it turned out, too much of a current destroyed the laser diode. This case left behind a disappointed customer – and a lost business opportunity. In other cases, for example, in security or medical technology, incorrect circuits can have far more serious implications!

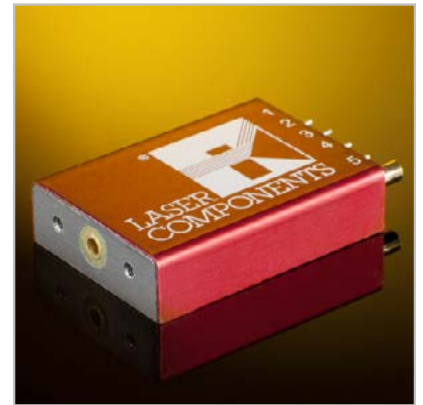

1 Time-of-flight Measurement – Operating Principle

Optical sensors for rangefinding from several meters to kilometers usually employ the time-of-flight (TOF) principle. The working principle is simple: a temporally modulated light pulse is sent out, sharply collimated by the emitter optics. From the arrival time of the reflected light the time of flight Δt can be determined. Using the speed of light, c , the distance l can be calculated. Since the light travels the distance twice, the result has to be divided by two. The refractivity of the surrounding medium, n , reduces the speed of light.

$$l = \frac{c \cdot \Delta t}{2 \cdot n} \quad (\text{Eq. 1})$$

Germany & Other Countries

Laser Components Germany GmbH
Tel: +49 8142 2864 - 0
Fax: +49 8142 2864 - 11
info@lasercomponents.com
www.lasercomponents.com

France

Laser Components S.A.S.
Tel: +33 1 39 59 52 25
Fax: +33 1 39 59 53 50
info@lasercomponents.fr
www.lasercomponents.fr

United Kingdom

Laser Components (UK) Ltd.
Tel: +44 1245 491 499
Fax: +44 1245 491 801
info@lasercomponents.co.uk
www.lasercomponents.co.uk

Nordic Countries

Laser Components Nordic AB
Tel: +46 31 703 71 73
Fax: +46 31 703 71 01
info@lasercomponents.se
www.lasercomponents.se

USA

Laser Components USA, Inc.
Tel: +1 603 821 - 7040
Fax: +1 603 821 - 7041
info@laser-components.com
www.laser-components.com

Due to the high speed of light (approximately $3 \cdot 10^8$ m/s) the challenge lies in the extremely short time intervals. For double the distance of 1.5 m the time of flight is 10 ns, at 15 cm it is only 1 ns. To measure 1.5 cm one would have to resolve 100 ps. For rangefinding with meter or even centimeter resolution trains of very short pulses of light are therefore required. Depending on the distance to be measured and the optics employed the required optical peak power ranges from several watts to more than 100 W for special ceilometers used in the measurement of cloud heights. Powerful pulsed laser diodes (PLDs) emitting in the near infrared (NIR) at 905 nm have become the standard in the market for this type of application. To generate such peak power levels, however, currents up to 50 A are required.

2 Pulsed Laser Diodes

The output power of laser diodes can primarily be adjusted through the applied operating voltage from which, at a given resistance, the operating current results. In NIR single-emitter PLDs the efficiency is typically 1 W/A. Epitaxially grown pulsed laser diodes with three laser diodes in one chip (multi junction PLDs) achieve much higher values of 2.5 to 2.8 W/A for the same current. The forward bias at the laser diode chip (neglecting inductances) is, with just a few volts, very small (Figure 1). These specifications are stated in the laser diode datasheets and usually refer to pulse durations of 100 – 200 ns. For shorter pulses the manufacturers promise that the PLDs can be overdriven with currents increased by a factor of up to 4. The duty cycle (i.e., the quotient of "on" and "off" times) is in the range of 0.04 to 0.1% and hence limits the working frequency of 10 ns pulses to 40 and 100 kHz, respectively. In "burst mode", however, pulse trains in the MHz range are possible.

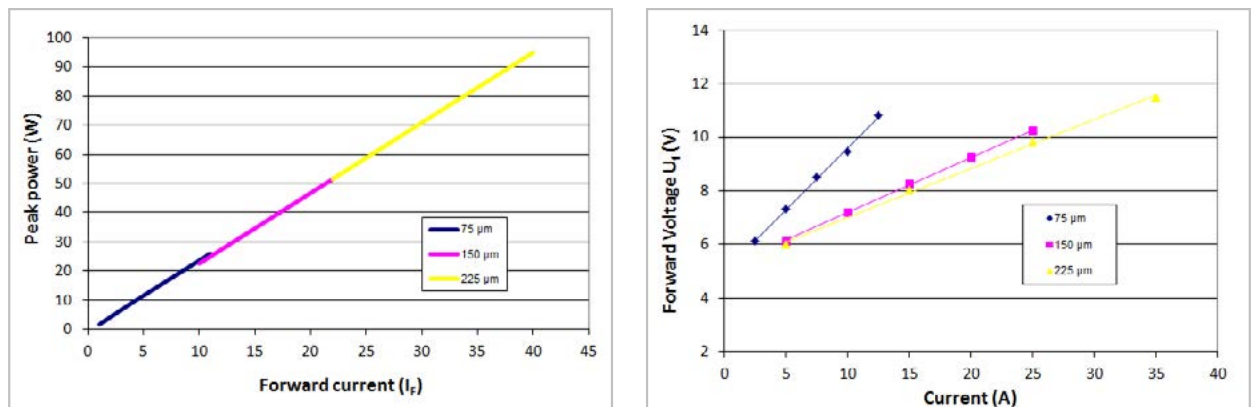

Figure 1:
Typical current/power curve (top) and forward bias for multi-junction pulsed laser diodes emitting at 905 nm
(color coding: three different emitter sizes)

3 Laser Diode Drivers

Since the pulse widths are in the ns range and the optical peak power requires currents of several amperes, special measures need to be taken to reliably switch such high currents within such short time intervals. At the same time, the form factor of the entire circuitry as well as the integrated components should be small enough to enable miniaturized and light-weight laser rangefinders for hunters, athletes, or golfers to be manufactured. Particularly for higher voltages or currents, where the size of the components increases, this can become quite a challenge.

Therefore, the main aspect in the design of a compact pulsed laser circuit or a complete pulsed laser module (PLM) is the combination of pulse power, pulse duration, and repetition frequency – in addition to steep pulse slopes.

In the simplest case a laser pulse can be triggered by switching the operating voltage on and off. Here the power supply sends a certain current through the laser diode when the switch is triggered which causes a certain power to be emitted. In technical applications this switch can be a transistor, for example, or a logic circuit. It is necessary, however, to use a driver as interface so that the switching occurs at the same power output stage the PLD is integrated in. Depending on the required rise time and the pulse width either power metal oxide semiconductor field effect transistors (MOSFETs) or avalanche transistors are used. Figure 2 shows a typical PLD circuit for a power output stage featuring an avalanche transistor.

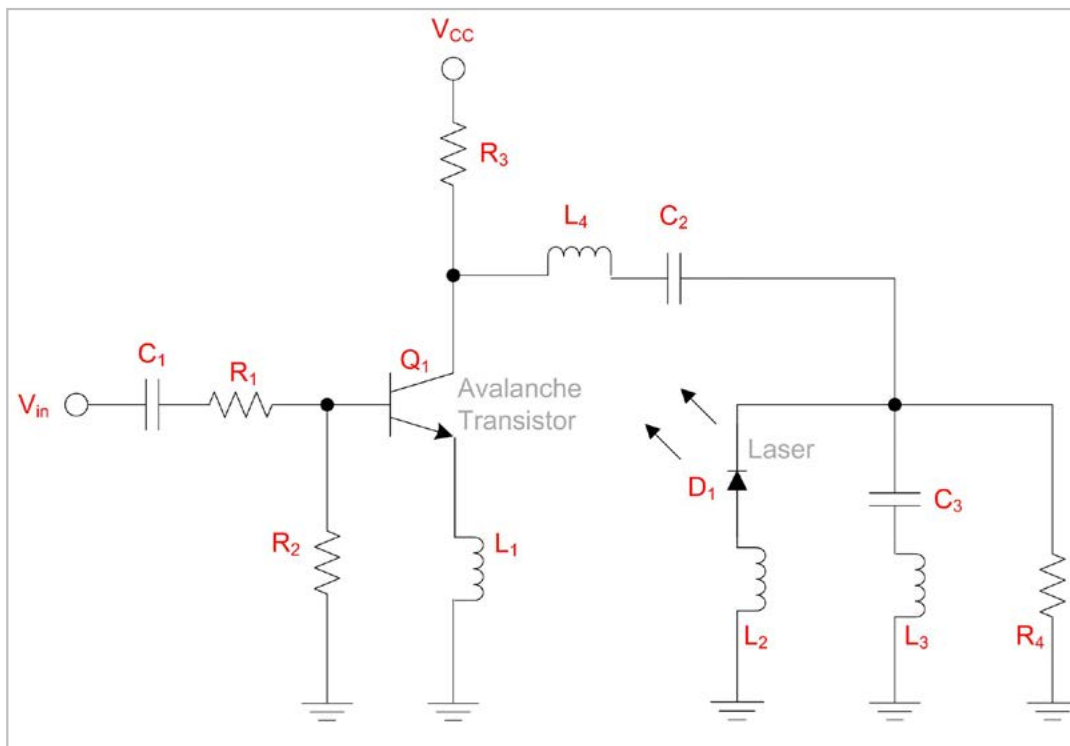

Figure 2:
PLD circuit for the power output stage using an avalanche transistor

The intended pulsed laser diode influences the circuit to a large extent.

The circuit design is determined by the maximum current that is allowed to run through the PLD at peak power levels as well as by the maximum permissible average power P_{ave} below the damage threshold. P_{ave} is calculated as the product:

$$P_{ave} = P_0 \cdot t_w \cdot p_{rr} \quad (\text{Eq. 2})$$

where P_0 is the peak power, t_w the pulse width, and p_{rr} the repetition frequency.

Capacitor C2 serves as storage for the pulse current I_p and is charged through resistor R3 during the relatively long time interval between two pulses. The avalanche transistor then creates the pulse by completely discharging this capacitor. The duration of the pulse current running through the PLD is determined by the supply voltage V_{CC} and the capacitance C2.

A simple approximation of the charge capacitor's capacitance can be calculated like this:

$$C \cdot V = I_p \cdot t_w \quad (\text{Eq. 3})$$

Increasing the capacitor's capacitance leads to an increase in the pulse current I_p as well as in the pulse width t_w . If a higher supply voltage V_{CC} is applied, the amplitude of the current pulse increases. In practice, the pulse width is slightly reduced at the same time since the on-state resistance of the transistor is reduced.

4 Inductance, Capacitance, and Rise Time

To achieve short pulse widths it is important to keep parasitic inductances in the circuit to a minimum. For this reason, low-loss HF capacitors should be used. In addition to the self-inductance of the laser diode housing one should remember that each unnecessary cm in pin length causes an additional inductance of approximately 8 nH. This means that, for example, a rise in current di/dt of 20 A/10 ns creates a transient voltage Ldi/dt of 16 V per cm wire length. This is important because the rise time will significantly worsen at a given supply voltage if large inductances are present. The rise time can be approximated as follows:

$$T_{rise} = \frac{L_{stray} \cdot I_{Peak}}{V_{max} \cdot 0.9} \quad (\text{Eq. 4})$$

where L_{stray} is the inductance [nH] of the laser diode, I_{Peak} is the peak pulse current [A], and V_{max} [V] the maximum available supply voltage of the laser diode driver.

Figure 3 lists the inductances of different housings. If a PLD circuit can deliver a maximum supply voltage of, for example, 100 V, the following rise times result:

$$T_{rise} = \frac{11\text{nH} \cdot 50\text{A}}{100\text{V} \cdot 0.9} \geq 6.11\text{ns} \quad \text{when using a coax housing (11 nH)}$$

and

$$T_{rise} = \frac{5\text{nH} \cdot 50\text{A}}{100\text{V} \cdot 0.9} \geq 2.78\text{ns} \quad \text{when using a TO-56 housing (5.6 nH)}$$

Since unnecessary power wires have to be reduced to a minimum it is also particularly important to cut the pins of the laser diode as short as possible. An incorrect connection with pins or wires that are too long can lead, as described above, to an increased rise time.

Parasitic capacitances also increase delay, rise, and fall times. Figure 4 shows several typical examples of pulse shapes depending on the type of connection.



Figure 3:
Different types of PLD housings and their corresponding inductances

5 Avalanche Transistor or Power MOSFET

The pulse parameters required by the user – particularly pulse shape and pulse width – determine whether the circuit needs an avalanche transistor or a power MOSFET. When making a selection one has to bear in mind that the transistor needs to withstand the operating current of the PLD unharmed. This current, however, does not need to flow permanently between source and drain but rather in ns pulses. Further requirements for the transistor are a preferably short delay, rise, and fall time which limits the selection of applicable transistors quite a bit. Short delay times are contrary to a large drain current. Finally, it is imperative that the reverse voltage of the transistor is larger than the charging voltage of the capacitor (see C2 in Figure 2).

In practice, power MOSFETs are employed to switch current pulses of more than 100 A within a few tens of ns. This creates pulses with rise and fall times of several ns. The advantage of these inexpensive and very small transistors is that already with a maximum charge voltage of 60 V very well-shaped rectangular pulses can be implemented (Figure 5).

Avalanche transistors are optimally suited for the generation of very short and powerful pulses. Rise times of <math>< 1\text{ ns}</math> and peak currents of >100 A are possible. One particular manufacturer of avalanche transistors for pulsed laser circuits is DIODES Inc. (former Zetex). However, as can be seen in the datasheet of the, for example, ZTX415, a high voltage in the triple digits is required. Figure 6 shows the minimum voltage required for avalanche operation at different drive currents depending on the capacitance. The currents I_b indicated in the diagram are continuous currents, pulsed currents can reach 60 A (at 20 ns) or more for shorter pulses. Attention during the design of the power supply has to be paid if these high currents and voltages are to be switched with several 10 or 100 kHz. Since not every developer is familiar with the switching of this sort of currents and voltages, ready assembled driver boards or complete pulsed laser modules are offered as well.



PLD directly connected to the driver
Current rise time approx. 3.5 ns

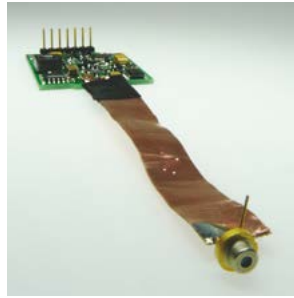

PLD connected by ribbon cable
Current rise time approx. 7 ns



PLD in plastic housing and long pins
Current rise time approx. 12 ns



PLD connected by braided wires (length: 100 mm)
Current rise time approx. >130 ns

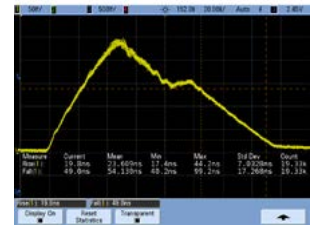
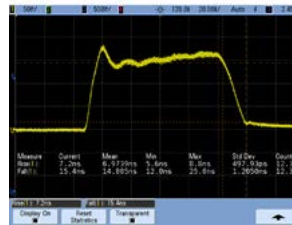
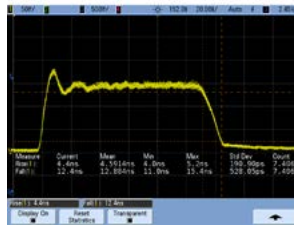
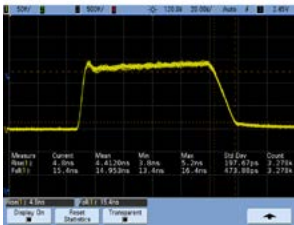

Figure 4: Typical pulse shapes depending on the type of connection between driver and PLD ($V_{op} = 100\text{ V}$, $I_{op} = 50\text{ A}$)

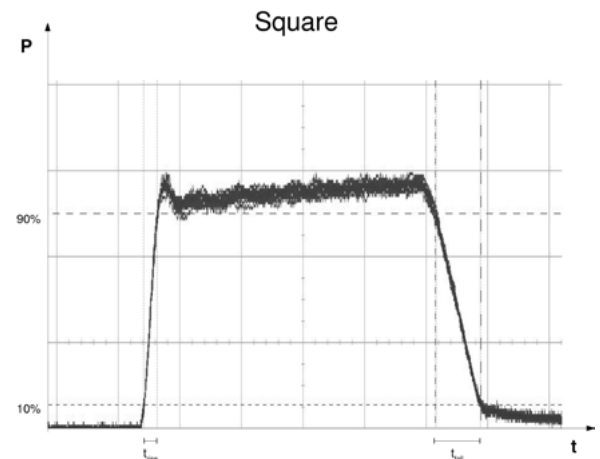
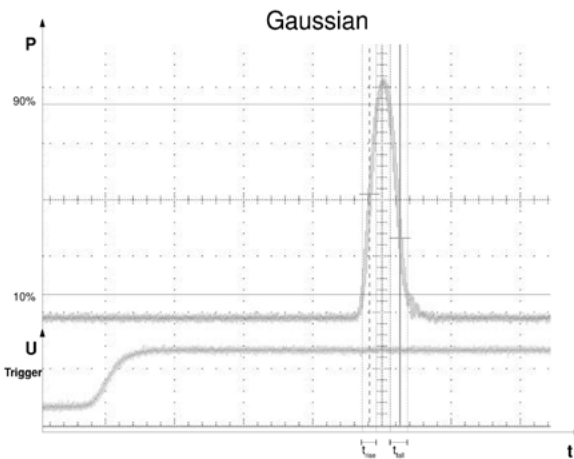

Figure 5: Typical shape of a current pulse generated by a power MOSFET (right) and an avalanche transistor.

Summary

In laser ranging via time-of-flight inexpensive pulsed laser diodes have become the standard. In order for the sensors to stay small and portable and to achieve a suitable resolution, special requirements are placed on the circuit. For example, connecting wires cause parasitic inductances and, therefore, have to be kept as short as possible in order to create fast and precise laser pulses using power MOSFETs or avalanche transistors.

References:

- [1] A. Kilpela, Pulsed time-of-flight laser range finder techniques for fast, high precision measurement applications, Department of Electrical and Information Engineering, University of Oulu, Finland
- [2] S. Ch. Tischler, Die Entwicklung eines Pulsmoduls, ser. no. 2458, Hochschule München, Fakultät für Elektrotechnik und Informationstechnik
- [3] Acam mess electronic, Laserentfernungsmessung mit TDCs, Applikationsschrift Nr. 1
- [4] PicoLAS, Application Note # 02: Impedance of Laser Diodes, Inductive Behaviour, Application Note # 03: LD-Connections
- [5] Zetex, The ZTX415 Avalanche Mode Transistor, Application Note 8, Issue 2, January 1996

Germany & Other Countries

Laser Components Germany GmbH
Tel: +49 8142 2864 - 0
Fax: +49 8142 2864 - 11
info@lasercomponents.com
www.lasercomponents.com

France

Laser Components S.A.S.
Tel: +33 1 39 59 52 25
Fax: +33 1 39 59 53 50
info@lasercomponents.fr
www.lasercomponents.fr

United Kingdom

Laser Components (UK) Ltd.
Tel: +44 1245 491 499
Fax: +44 1245 491 801
info@lasercomponents.co.uk
www.lasercomponents.co.uk

Nordic Countries

Laser Components Nordic AB
Tel: +46 31 703 71 73
Fax: +46 31 703 71 01
info@lasercomponents.se
www.lasercomponents.se

USA

Laser Components USA, Inc.
Tel: +1 603 821 - 7040
Fax: +1 603 821 - 7041
info@laser-components.com
www.laser-components.com