

## Infrared Laser Diode

### **ADL-80V03TL**

6-2D-LD80-010\_Rev.00

### **808nm 500mW High Power Operation**

#### • Features

1. Low operation current
2. High pumping efficiency
3. Stable wavelength
4. High reliability

#### • Applications

1. Pumping source for DPSS green laser
2. Medical applications

#### • Absolute maximum ratings

Parameter	Symbol	Condition	Rating	Unit
Light output power	$P_O$	CW	510	mW
Reverse voltage (LD)	$V_{RL}$		2	V
Reverse voltage (PD)	$V_{RD}$		30	V
Forward current (PD)	$I_{FD}$		10	mA
Case temperature	$T_C$	-	-10~+50	°C
Storage temperature	$T_S$	-	-40~+85	°C

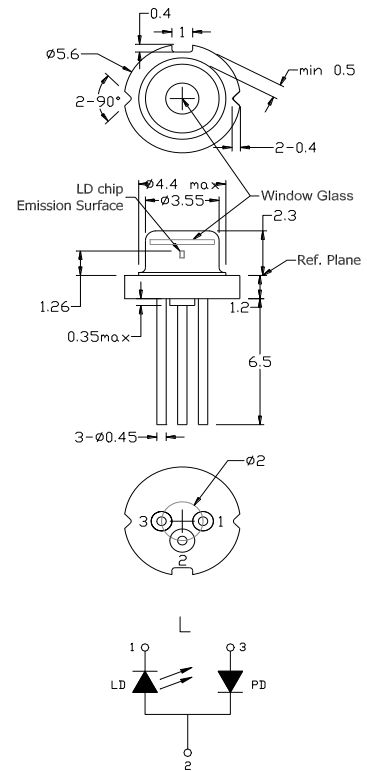

#### • Electrical and optical characteristics ( $T_c=25^\circ\text{C}$ )

Parameter	Symbol	Min.	Typ.	Max.	Unit	Conditions (CW)
Peak wavelength	$\lambda$	805	808	811	nm	$P_o=500\text{mW}$
Threshold current	$I_{th}$	-	120		mA	
Operating current	$I_{op}$	-	570		mA	
Operating voltage	$V_{op}$	-	1.9	2.1	V	$P_o=400\text{-}500\text{mW}$
Differential efficiency	$\eta$	0.8	1.2	-	mW/mA	
Parallel divergence angle	$\theta_{//}$	-	8	11	deg	$P_o=500\text{mW}$
Monitor current - L type	$I_m$	1.2	1.7	3	mA	
Perpendicular divergence angle	$\theta_{\perp}$	-	39	48	deg	
Parallel FFP deviation angle	$\Delta\theta_{//}$	-3	0	+3	deg	
Perpendicular FFP deviation angle	$\Delta\theta_{\perp}$	-5	0	+5	deg	
Emission point accuracy	$\Delta x \Delta y \Delta z$	-80	0	+80	um	

#### • Precautions

- \* Do not operate the device above maximum ratings. Doing so may cause unexpected and permanent damage to the device.
- \* Take precautions to avoid electrostatic discharge and/or momentary power spikes. A change in the characteristics of the laser or premature failure may result.
- \* Proper heat sinking of the device assures stability and lifetime. Always ensure that maximum operating temperatures are not exceeded.
- \* Observing visible or invisible laser beams with the human eye directly, or indirectly, can cause permanent damage. Use a camera to observe the laser.
- \* No laser device should be used in any application or situation where life or property is at risk in event of device failure.
- \* Specifications are subject to change without notice. Ensure that you have the latest specification by contacting us prior to purchase or use of the product.

\* For reference only. Contents above are subject to change without notice.

# Infrared Laser Diode

## ADL-80V03TL

6-2D-LD80-010\_Rev.00

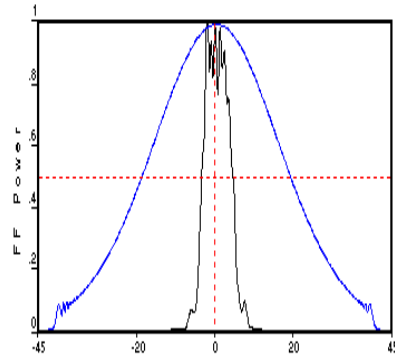
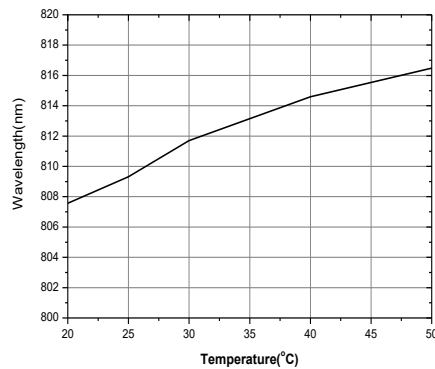
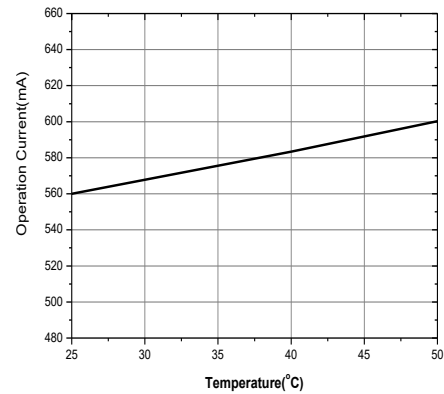
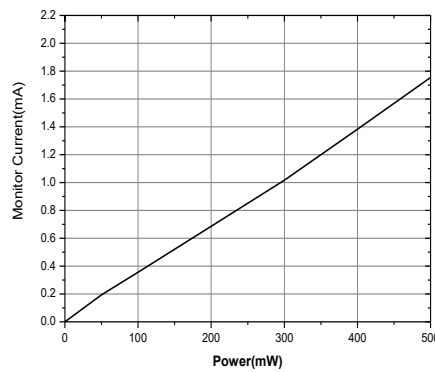
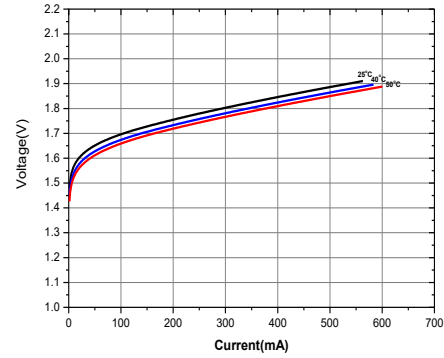
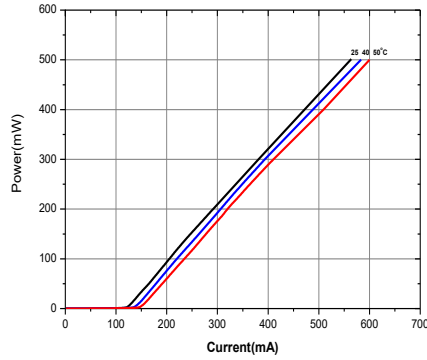

\* For reference only. Contents above are subject to change without notice.